



**DO IT NATURAL,  
DRINK IT VEGETAL.  
OR WAS IT BACKWARDS?**

**PREPARE YOUR OWN  
100% NATURAL  
PLANT-BASED MILK**



FRESHLY  
EXTRACTED

NO ADDED  
SUGARS

WITHOUT  
ADITIVES

**OATS · SOJA  
ALMONDS · RICE  
COCONUT**  
OR WHATEVER YOU PREFER



**milker**  
by Jata

With the **MILKER** by Jata  
you can prepare your own  
plant-based milk easily,  
quickly, and healthily.

[www.jata.es](http://www.jata.es)



LOGISTICS DATA **10**



BEAUTY **29**

**MARCO ALDANY**

|          |    |
|----------|----|
| JBSC5577 | 30 |
| JBPP5570 | 30 |
| JBCP5544 | 30 |

**HAIR CLIPPERS**

|          |    |
|----------|----|
| PS33B    | 31 |
| MP59B    | 31 |
| JBMA1400 | 31 |
| JBCP3700 | 32 |
| JBCP4000 | 32 |
| JBCP4200 | 33 |
| JBCP3305 | 33 |
| JBCP3310 | 33 |
| JBSE2102 | 34 |
| JBCP3315 | 34 |
| JBCP3325 | 35 |
| MP373N   | 35 |
| MP36B    | 35 |
| JBCP3538 | 36 |
| MP423    | 37 |
| CN12B    | 37 |
| CN15B    | 37 |

**PERSONAL CARE**

|          |    |
|----------|----|
| JBSM1200 | 38 |
| DL87B    | 38 |

**HAIR DRYERS**

|          |    |
|----------|----|
| JBSC1195 | 40 |
| JBSC1065 | 40 |
| JBSC1290 | 41 |
| SC1013   | 42 |
| JBSC1430 | 42 |
| JBSC1440 | 43 |
| SC56B    | 44 |
| SC43B    | 44 |
| SC47B    | 44 |

**HAIR BRUSHES**

|          |    |
|----------|----|
| JBCA1901 | 45 |
| JBSC2211 | 45 |

**HAIR STRAIGHTENERS**

|          |    |
|----------|----|
| JBSE2101 | 46 |
| PP1065   | 46 |
| JBPP1588 | 47 |



**BODY ANALYZERS**

|          |    |
|----------|----|
| HBAS0501 | 48 |
| 531      | 48 |
| 532      | 48 |
| 80       | 49 |
| 538      | 49 |
| 577      | 49 |
| HBAS1524 | 50 |
| HBAS1155 | 51 |

**SPECIAL SCALES**

|          |    |
|----------|----|
| HBAS1907 | 52 |
| 535      | 53 |
| HBAS1499 | 53 |
| HBAS1417 | 53 |

|          |    |
|----------|----|
| HBAS1416 | 54 |
| 517      | 54 |

**ELECTRONIC AND MECHANICAL SCALES**

|          |    |
|----------|----|
| HBAS1415 | 55 |
| 294K     | 55 |
| 295K     | 55 |
| 489      | 56 |
| 498      | 56 |
| 496N     | 56 |
| 290N     | 57 |
| HBAS1290 | 57 |
| HBAS1291 | 57 |
| HBAS1292 | 57 |
| HBAS1424 | 58 |
| HBAS1492 | 58 |
| 70       | 58 |

**HEATING PADS**

|          |    |
|----------|----|
| CT10     | 59 |
| CT20     | 59 |
| JCAE5220 | 59 |
| JCAE5422 | 59 |
| CT30     | 59 |



SEWING **61**

**SEWING MACHINES**

|          |    |
|----------|----|
| MC695    | 62 |
| JSMC5217 | 62 |
| MC744    | 62 |
| MC740    | 62 |
| JSMC1120 | 63 |
| MC823    | 64 |

**OVERLOCKER**

OL902 64

**SEWING BOX**

AC45 64



**HOME 65**

**IRONING**

PL120 66

PL225 66

PL221C 66

JEPL2241 67

JEPL1221 68

PL618 68

PL598C 68

PL622C 69

PL1058C 69

JEPL2401 70

JEPL3242 71

JEPL7000 72

JEPL2810 72

PL357N 72

**STEAM STATION**

JECP8522 73

JECP8523 73

**CLOTHING CARE**

HPLA8000 74

HPLA5211 74

HPLA8020 74

HPLA5212 74

PT10 74

HPLA5210 74

HPLA8115 75

HPLA8110 75

MOD 800 75

**IRONING BOARDS**

848S-01 76

HPLA8100 76

TP500 76

TP520 77

TP550 77

HPLA8242 78

HPLA8241 78

TP600 79

HPLA8214 79

HPLA5213 79

HFUN8014 79

TM200 79

**CLOTHES LINES**

HTEN2370 80

HTEN2375 80

HTEN2402 81

HTEN2403 81

**LINT SHAVERS**

QP398N 82

JEQP5218 82

QP620 82

JEQP6688 82



**VACUUM CLEANERS**

AP998 83

AP999 83

AP915 83

JEAP1950 84

JEAP1629 84

**AIR**

HU996 85

HU992 85

JEHU5408 85

JEGA1001 85

JEHU2420 86

JEHU2413 86



**KITCHEN 87**

**JUICERS**

JEEX1046 88

EX1057 88

JEEX1058 89

JEEX1155 89

JEEX1045 89

EX1054 90

JEEX1059 90

JEEX1422 91

EX421 91

EX296 91

JEEX1423 92

JEEX1712 92

JEEX1549 93

**JUICE EXTRACTOR**

JELI1201 94

JELI1580 94

**TOASTERS**

TT579 95

TT632 95

JETT1579 95

|          |     |
|----------|-----|
| TT631    | 96  |
| TT331    | 96  |
| JETT1048 | 96  |
| JETT1262 | 97  |
| JETT1585 | 98  |
| JETT1584 | 98  |
| TT1046   | 99  |
| TT1043   | 99  |
| JETT1588 | 99  |
| JETT1587 | 100 |
| TT587    | 100 |
| TT589    | 100 |
| TT589NG  | 100 |
| JETT0201 | 101 |
| TT588    | 101 |
| TT591    | 101 |
| TT5016   | 101 |



**ELECTRIC COFFEE MAKERS**

|          |     |
|----------|-----|
| JECA1287 | 102 |
| CA288N   | 102 |
| CA290    | 103 |
| JECA1750 | 104 |
| JECA1752 | 104 |
| JECA1800 | 105 |
| JECA2300 | 106 |
| JECA1512 | 107 |

**GRINDERS**

|          |     |
|----------|-----|
| JEML1150 | 107 |
| ML132    | 108 |
| ML133    | 108 |

**MILK FROTHER**

|          |     |
|----------|-----|
| JEES1111 | 107 |
| JECL1900 | 108 |

**MILK WARMERS**

|          |     |
|----------|-----|
| JECL1820 | 108 |
| CL819    | 108 |

**KETTLES**

|          |     |
|----------|-----|
| JEHA1723 | 110 |
| JEHA1575 | 110 |
| JEHA1809 | 111 |
| HA702    | 111 |
| HA701    | 111 |
| JEHA1038 | 112 |
| JEHA1808 | 112 |
| JEHA1240 | 113 |
| HA547    | 113 |



**ELECTRIC GRILLS**

|          |     |
|----------|-----|
| GR3000   | 114 |
| JEGR2851 | 115 |
| GR2600   | 115 |
| JT950    | 115 |
| GR558    | 116 |
| GR557A   | 116 |
| GR555A   | 117 |
| GR669    | 117 |
| GR559    | 117 |
| JEGR0550 | 118 |
| GR195    | 119 |
| GR217    | 119 |

|          |     |
|----------|-----|
| JEGR1603 | 119 |
| JEGR1241 | 120 |
| GR204N   | 121 |
| GR205    | 121 |
| JEGR5522 | 121 |

**ELECTRIC PAELLA PANS**

|          |     |
|----------|-----|
| PE550    | 122 |
| JEPE1639 | 122 |
| PE640    | 122 |



**BARBECUES**

|          |     |
|----------|-----|
| JEBQ1001 | 123 |
| JEBQ1002 | 123 |
| EBQ2     | 124 |
| BQ108    | 124 |
| BQ95     | 124 |
| BQ101    | 125 |

**GRILLS**

|          |     |
|----------|-----|
| GR266    | 126 |
| SET266   | 126 |
| AC266    | 126 |
| R266     | 126 |
| JEGR1107 | 127 |
| JEGR1124 | 127 |
| JEGR1595 | 128 |
| GR1100   | 128 |
| JEGR1106 | 129 |
| JEGR1913 | 129 |
| JEGR1450 | 130 |
| JEGR1596 | 131 |





## SANDWICH MAKERS

|          |     |
|----------|-----|
| JESW1232 | 132 |
| JESW1231 | 132 |
| SW551    | 133 |
| JESW1551 | 133 |
| SW546    | 133 |

## MILKER

|          |     |
|----------|-----|
| JELV2350 | 134 |
| JELV2300 | 134 |
| JEEM2450 | 135 |

## BLENDERS

|          |     |
|----------|-----|
| JEBT1241 | 136 |
| BT1056   | 136 |
| BT795    | 137 |
| JEBT1500 | 137 |
| BT604N   | 138 |
| BT5030   | 138 |
| JEBT1265 | 138 |
| BT265    | 138 |
| JEBT1243 | 139 |
| BT797    | 140 |
| JEBT1001 | 140 |



## MIXERS

|          |     |
|----------|-----|
| JEBT1124 | 141 |
| JEBT1906 | 141 |
| BT126    | 142 |

|          |     |
|----------|-----|
| BT158    | 142 |
| JEBT1945 | 142 |
| JEBT1790 | 142 |
| JEBT1852 | 143 |
| BT175    | 143 |
| JEBT1853 | 143 |
| BT176    | 144 |
| BT5025   | 144 |
| BT177    | 144 |
| BT185    | 144 |
| BT166    | 145 |
| BT199    | 145 |
| JEBT5026 | 145 |
| BT169    | 146 |
| JEBT1855 | 146 |
| JEBT1788 | 147 |
| BT159    | 148 |
| JEBT1851 | 148 |
| JEBT1791 | 148 |

## KNEADERS

|          |     |
|----------|-----|
| JEMA1240 | 149 |
| BT575    | 150 |
| MZ670    | 150 |
| FP500P   | 150 |
| JEMA5502 | 151 |
| JEMA1502 | 151 |



## FRYERS

|          |     |
|----------|-----|
| JEFR1221 | 152 |
| JEFR1223 | 152 |
| JEFR5392 | 152 |
| JEFR1222 | 153 |

|          |     |
|----------|-----|
| JESA2090 | 153 |
| JEFR1226 | 154 |
| JEFR1224 | 154 |
| JEFR1227 | 154 |
| JEFR1225 | 155 |
| JEFR1229 | 155 |
| JEFR1230 | 156 |
| JEFR1270 | 156 |
| JEFR1242 | 157 |
| JEFR1228 | 158 |
| JEFR1816 | 158 |
| FR326E   | 159 |
| FR5600   | 159 |
| FR115    | 160 |
| FR278    | 160 |
| FR680    | 160 |
| FR678    | 161 |
| FR700    | 161 |



## OVENS

|          |     |
|----------|-----|
| JEHN0910 | 162 |
| HN916    | 162 |
| HN921    | 162 |
| HN928    | 162 |
| HN936    | 163 |
| HN966    | 163 |
| HN945    | 163 |

## ELECTRIC KITCHENS

|          |     |
|----------|-----|
| JECE1233 | 164 |
| CE220    | 164 |
| V531     | 164 |
| V532     | 164 |

|          |     |
|----------|-----|
| JEVI1470 | 165 |
| JEVI1460 | 166 |
| VIN145   | 166 |
| V139     | 167 |
| V140     | 167 |
| V141     | 167 |
| V142     | 167 |

**GAS COOKERS**

|          |     |
|----------|-----|
| JECG2701 | 168 |
| JECG2721 | 168 |
| JECG2702 | 168 |
| JECG2703 | 168 |



**STEAM COOKERS**

|        |     |
|--------|-----|
| CV200  | 169 |
| CV5020 | 169 |
| CV623  | 169 |

**SLOW COOKER**

|          |     |
|----------|-----|
| JEOL2145 | 170 |
| JEOL2135 | 170 |

**ELECTRIC RICE COOKERS**

|       |     |
|-------|-----|
| AR393 | 171 |
| AR394 | 171 |

**YOGURT MAKERS**

|          |     |
|----------|-----|
| JEYG2266 | 172 |
| JREC2266 | 172 |

**CREPE MAKER**

|          |     |
|----------|-----|
| JECR1000 | 172 |
|----------|-----|

**POPCORN MACHINE**

|       |     |
|-------|-----|
| PAL97 | 173 |
|-------|-----|

**CHOPPERS**

|          |     |
|----------|-----|
| PC123N   | 173 |
| JEPC1250 | 173 |

**FOOD SLICERS**

|          |     |
|----------|-----|
| CF1053   | 174 |
| JECF1200 | 174 |
| JECF0300 | 175 |
| JECF1820 | 175 |

**VACUUM PACKERS**

|          |     |
|----------|-----|
| EV1026   | 176 |
| JEEV2210 | 176 |
| EV109    | 176 |
| JEEV2240 | 177 |
| R22x6    | 177 |
| R28x6    | 177 |
| B22x30   | 177 |
| B28x40   | 177 |



**NON ELECTRIC KITCHENWARE 179**

**WATER JARS**

|          |     |
|----------|-----|
| JH01     | 180 |
| HJAR1001 | 180 |
| HJAR1003 | 181 |

**WATER FILTERS**

|         |     |
|---------|-----|
| RE123X4 | 181 |
|---------|-----|

**ELECTRONIC AND MECHANICAL SCALES**

|          |     |
|----------|-----|
| 55K      | 182 |
| HBAL1204 | 182 |
| HBAL1300 | 183 |
| 720      | 184 |
| HBL0310  | 184 |
| 719      | 184 |
| HBL0300  | 184 |
| 775      | 185 |

|          |     |
|----------|-----|
| HBAL1709 | 185 |
|----------|-----|

|     |     |
|-----|-----|
| 762 | 186 |
|-----|-----|

|          |     |
|----------|-----|
| HBAL1775 | 186 |
|----------|-----|

|          |     |
|----------|-----|
| HBAL1774 | 187 |
|----------|-----|

|          |     |
|----------|-----|
| HBAL1207 | 187 |
|----------|-----|

|     |     |
|-----|-----|
| 721 | 187 |
|-----|-----|

|          |     |
|----------|-----|
| HBAL1220 | 187 |
|----------|-----|

|          |     |
|----------|-----|
| HBAL1254 | 188 |
|----------|-----|

|     |     |
|-----|-----|
| 773 | 189 |
|-----|-----|

|          |     |
|----------|-----|
| HBAL0370 | 189 |
|----------|-----|

|          |     |
|----------|-----|
| HBAL1208 | 189 |
|----------|-----|

|          |     |
|----------|-----|
| HBAL1202 | 189 |
|----------|-----|

|      |     |
|------|-----|
| 731K | 189 |
|------|-----|

|      |     |
|------|-----|
| 732K | 190 |
|------|-----|

|          |     |
|----------|-----|
| HBAL0350 | 190 |
|----------|-----|

|          |     |
|----------|-----|
| HBAL1203 | 190 |
|----------|-----|

|      |     |
|------|-----|
| 729R | 190 |
|------|-----|

|      |     |
|------|-----|
| 729V | 190 |
|------|-----|

|     |     |
|-----|-----|
| 722 | 191 |
|-----|-----|

|      |     |
|------|-----|
| 722P | 191 |
|------|-----|

|       |     |
|-------|-----|
| 722CS | 191 |
|-------|-----|

|          |     |
|----------|-----|
| HBAL7230 | 192 |
|----------|-----|

|          |     |
|----------|-----|
| HBAL7240 | 192 |
|----------|-----|

|      |     |
|------|-----|
| 610N | 193 |
|------|-----|

|          |     |
|----------|-----|
| HBAL1110 | 193 |
|----------|-----|



**COFFEE MAKERS**

|          |     |
|----------|-----|
| HCAF1135 | 194 |
|----------|-----|

|          |     |
|----------|-----|
| HCAF1160 | 194 |
|----------|-----|

|        |     |
|--------|-----|
| CAX104 | 195 |
|--------|-----|

|        |     |
|--------|-----|
| CAX106 | 195 |
|--------|-----|

|        |     |
|--------|-----|
| CAX110 | 195 |
|--------|-----|

|          |     |
|----------|-----|
| CAX112   | 195 |
| CCA3     | 196 |
| CCA6     | 196 |
| CCA9     | 196 |
| CCA12    | 196 |
| CFI6     | 196 |
| CFI9     | 196 |
| CFI12    | 196 |
| HCAF2006 | 196 |
| HCAF2009 | 196 |
| HCAF2012 | 196 |
| HCAF2403 | 197 |
| HCAF2406 | 197 |
| HCAF2409 | 197 |
| HCAF2412 | 197 |



## PRESSURE COOKERS

|          |     |
|----------|-----|
| HOLL2226 | 198 |
| HOLL2228 | 198 |
| HOLL2230 | 198 |
| OPC4     | 198 |
| OPC6     | 198 |
| OPC8     | 198 |
| OPC10    | 198 |
| OSR4     | 199 |
| OSR6     | 199 |
| OSR8     | 199 |

## GRILLS

|       |     |
|-------|-----|
| GR33  | 200 |
| GR25  | 200 |
| GMA28 | 200 |
| GP35  | 200 |

## FRY PANS AND SAUCE PANS

|                     |     |
|---------------------|-----|
| TAAL                | 201 |
| SF9                 | 202 |
| CF916               | 202 |
| CF9                 | 202 |
| TF9                 | 202 |
| HSAR21_ LA GARROTXA | 203 |
| HPAE21_ LA GARROTXA | 204 |
| SEW_                | 205 |
| SF1_                | 205 |
| SET SF1 2024        | 205 |
| SET SF1 182226      | 205 |
| HSAR2402            | 206 |
| HSAR2403            | 206 |
| SMH14               | 206 |

## COOKWARE SETS

|      |     |
|------|-----|
| BC3  | 207 |
| BC8  | 207 |
| BC10 | 207 |

## GLASS LIDS

|     |     |
|-----|-----|
| T16 | 206 |
| T20 | 206 |
| T26 | 206 |

## TABLE MAT

|          |     |
|----------|-----|
| HACC4546 | 206 |
|----------|-----|



## SILICONE MOULDS

|          |     |
|----------|-----|
| HSET1234 | 209 |
| HMOL5211 | 209 |
| HMOL5212 | 209 |
| HMOL5213 | 209 |
| MC60     | 210 |

|          |     |
|----------|-----|
| HMOL5216 | 210 |
| MC61     | 210 |
| HMOL5214 | 210 |
| MC62     | 210 |
| HMOL5219 | 210 |
| MC64     | 210 |
| HMOL5215 | 210 |
| MC67     | 210 |
| HMOL5218 | 210 |
| MC68     | 210 |
| HMOL2065 | 210 |
| HMOL1124 | 211 |
| HMOL1324 | 211 |
| AC40     | 211 |
| HACC4540 | 211 |



## ACCESORIES

|          |     |
|----------|-----|
| HACC4624 | 212 |
| HACC4600 | 213 |
| HACC4301 | 213 |
| HACC4303 | 213 |
| HACC4304 | 213 |
| HACC4305 | 213 |
| HACC4306 | 213 |
| HACC4307 | 213 |
| HACC5460 | 214 |
| AC1      | 215 |
| AC3      | 215 |
| AC4      | 215 |
| AC21     | 215 |
| AC23     | 215 |
| HACC4520 | 216 |



|          |     |
|----------|-----|
| AC24     | 216 |
| AC26     | 216 |
| AC28     | 216 |
| AC29     | 216 |
| AC30     | 216 |
| AC31     | 216 |
| AC32     | 216 |
| AC33     | 216 |
| AC34     | 216 |
| AC35     | 217 |
| AC25     | 217 |
| AC36     | 217 |
| HACC4522 | 217 |
| HACC4541 | 217 |
| HACC4502 | 218 |
| HACC4503 | 218 |
| HACC4504 | 218 |
| HACC4531 | 219 |
| HACC4530 | 220 |
| HACC4533 | 220 |
| HACC4524 | 220 |
| HACC4542 | 221 |
| HACC4543 | 221 |
| ARA30    | 221 |



**CUTTING**

|          |     |
|----------|-----|
| AC37     | 222 |
| AC38     | 222 |
| HACC4500 | 222 |
| AC54     | 223 |
| HMAQ4504 | 223 |
| HMAQ4501 | 223 |
| HMAQ4557 | 224 |

|          |     |
|----------|-----|
| AC57E    | 224 |
| HMAQ4506 | 224 |
| AC51     | 225 |
| HMAQ4505 | 225 |
| HMAQ4508 | 225 |

**OIL DISPENSERS**

|          |     |
|----------|-----|
| HACC4545 | 226 |
| HACC4537 | 226 |
| HACC4536 | 226 |
| HACC4535 | 226 |
| HACC4539 | 227 |

**CENTRIFUGE LETTUCE**

|          |     |
|----------|-----|
| HACC4554 | 227 |
|----------|-----|



**THERMIC FLASKS**

|          |     |
|----------|-----|
| HTER21_  | 228 |
| 942      | 228 |
| 943      | 228 |
| 825      | 229 |
| 827      | 229 |
| 83_      | 229 |
| 840      | 229 |
| 826      | 230 |
| 909      | 230 |
| 918      | 230 |
| 919      | 230 |
| 920      | 230 |
| HTER1011 | 231 |
| HTER1001 | 231 |

**THERMIC LUNCH BAGS**

|          |     |
|----------|-----|
| HPOR7202 | 232 |
| HPOR7203 | 232 |
| HPOR7056 | 232 |

|          |     |
|----------|-----|
| HPOR7051 | 233 |
| HPOR7052 | 233 |
| HPOR7055 | 233 |
| HPOR7054 | 233 |
| 985      | 234 |
| 954      | 234 |
| 980      | 234 |
| 970      | 234 |

**GLASS CONTAINERS**

|              |     |
|--------------|-----|
| HREC4200     | 235 |
| HREC4201     | 235 |
| HREC4202     | 235 |
| HREC4203     | 235 |
| SET HREC4204 | 235 |
| SET HREC4205 | 235 |



**VINUM SERIES**

|          |     |
|----------|-----|
| HVIN2323 | 237 |
| HVIN2201 | 237 |
| HVIN2302 | 238 |
| HVIN2300 | 238 |
| HVIN2202 | 238 |
| HVIN2212 | 238 |
| HVIN2314 | 239 |
| HVIN2205 | 239 |
| HVIN2204 | 240 |
| HVIN2206 | 240 |
| HVIN2215 | 240 |
| HVIN2207 | 241 |
| HVIN2208 | 241 |
| HVIN2200 | 241 |
| HBOX0122 | 242 |

| REFERENCE                        | EAN13         | ITF14          | UNIT BOX (cm) |        |        | UNITS PER PACKAGING | PACKAGING (cm) |        |        | PALLET |       |             | WEIGHT (Kg) |
|----------------------------------|---------------|----------------|---------------|--------|--------|---------------------|----------------|--------|--------|--------|-------|-------------|-------------|
|                                  |               |                | WIDTH         | LENGTH | HEIGHT |                     | WIDTH          | LENGTH | HEIGHT | BOXES  | UNITS | HEIGHT (cm) |             |
| <b>BEAUTY</b>                    |               |                |               |        |        |                     |                |        |        |        |       |             |             |
| <b>HAIR CLIPPERS</b>             |               |                |               |        |        |                     |                |        |        |        |       |             |             |
| <b>CN12B</b>                     | 8421078035763 | 18421078035760 | 4,5           | 11,5   | 17,0   | 12                  | 26,0           | 29,5   | 20,0   | 60     | 720   | 165         | 0,2         |
| <b>CN15B</b>                     | 8421078031154 | 18421078031151 | 3,0           | 7,5    | 20,0   | 28                  | 24,0           | 33,5   | 23,0   | 66     | 1848  | 159         | 0,1         |
| <b>JBCP3305</b>                  | 8421078036326 | 18421078036323 | 8,0           | 14,5   | 22,0   | 6                   | 27,5           | 31,0   | 25,0   | 50     | 300   | 153         | 0,5         |
| <b>JBCP3310</b>                  | 8421078036333 | 18421078036330 | 5,5           | 8,5    | 18,5   | 6                   | 18,5           | 20,0   | 19,0   | 128    | 768   | 163         | 0,3         |
| <b>JBCP3315</b>                  | 8421078037323 | 18421078037320 | 5,0           | 15,0   | 18,0   | 6                   | 17,0           | 32,0   | 20,0   | 128    | 768   | 175         | 0,4         |
| <b>JBCP3325</b>                  | 8421078037330 | 18421078037337 | 6,0           | 14,0   | 23,0   | 6                   | 16,0           | 38,5   | 25,0   | 90     | 540   | 165         | 0,6         |
| <b>JBCP3538</b>                  | 8421078039020 | 18421078039027 | 0,0           | 0,0    | 0,0    | 8                   | 0,0            | 0,0    | 0,0    | 0      | 0     | 0           |             |
| <b>JBCP3700</b>                  | 8421078038306 | 18421078038303 | 6,0           | 8,5    | 18,5   | 8                   | 20,5           | 24,0   | 19,5   | 120    | 960   | 171         | 0,3         |
| <b>JBCP4000</b>                  | 8421078036555 | 18421078036552 | 7,0           | 11,5   | 23,0   | 4                   | 13,0           | 30,0   | 25,0   | 120    | 480   | 168         | 0,7         |
| <b>JBCP4200</b>                  | 8421078037347 | 18421078037344 | 5,5           | 8,0    | 18,5   | 6                   | 18,0           | 20,0   | 19,5   | 192    | 1152  | 171         | 0,3         |
| <b>JBCP5544</b>                  | 8421078038412 | 18421078038419 | 7,0           | 11,0   | 22,5   | 4                   | 13,0           | 30,0   | 25,5   | 100    | 400   | 140         | 0,7         |
| <b>JBMA1400</b>                  | 8421078036319 | 18421078036316 | 8,0           | 10,0   | 19,0   | 6                   | 21,5           | 25,5   | 21,5   | 84     | 504   | 166         | 0,3         |
| <b>JBSE2102</b>                  | 8421078036623 | 18421078036620 | 6,0           | 21,0   | 22,5   | 8                   | 27,5           | 44,0   | 25,0   | 36     | 288   | 162         | 0,6         |
| <b>MP36B</b>                     | 8421078035695 | 18421078035692 | 5,5           | 13,5   | 19,5   | 12                  | 28,0           | 36,5   | 22,0   | 56     | 672   | 169         | 0,4         |
| <b>MP373N</b>                    | 8421078022893 | 18421078022890 | 7,5           | 13,5   | 18,0   | 12                  | 24,5           | 37,5   | 31,0   | 45     | 540   | 170         | 0,6         |
| <b>MP423</b>                     | 8421078034858 | 18421078034855 | 5,5           | 13,0   | 24,0   | 8                   | 26,5           | 29,0   | 27,0   | 60     | 480   | 175         | 0,5         |
| <b>MP59B</b>                     | 8421078034070 | 18421078034077 | 4,5           | 12,0   | 17,0   | 12                  | 25,5           | 29,0   | 20,0   | 60     | 720   | 135         | 0,3         |
| <b>PS33B</b>                     | 8421078034087 | 18421078034084 | 8,0           | 20,0   | 19,5   | 12                  | 26,5           | 42,0   | 42,0   | 18     | 216   | 155         | 0,6         |
| <b>PERSONAL CARE</b>             |               |                |               |        |        |                     |                |        |        |        |       |             |             |
| <b>DL87B</b>                     | 8421078032311 | 18421078032318 | 5,8           | 16,0   | 19,0   | 12                  | 33,3           | 36,1   | 21,0   | 55     | 660   | 178         | 0,4         |
| <b>DPC8B</b>                     | 8421078031895 | 18421078031892 | 24,5          | 25,0   | 12,9   | 2                   | 25,9           | 27,8   | 27,0   | 60     | 120   | 175         | 1,9         |
| <b>JBSM1200</b>                  | 8421078036340 | 18421078036347 | 4,5           | 10,0   | 20,5   | 6                   | 14,5           | 21,5   | 21,0   | 203    | 1218  | 162         | 0,3         |
| <b>SM100B</b>                    | 8421078033103 | 18421078033100 | 3,3           | 8,5    | 23,8   | 12                  | 24,5           | 27,2   | 15,1   | 96     | 1152  | 163         | 0,1         |
| <b>PERSONAL CARE SPARE PARTS</b> |               |                |               |        |        |                     |                |        |        |        |       |             |             |
| <b>RM34A</b>                     | 8421078034971 | 18421078034978 | 2,0           | 9,5    | 10,5   | 12                  | 16,5           | 18,0   | 12,5   | 40     | 480   | 66          | 0,0         |
| <b>RM34B</b>                     | 8421078034995 | 18421078034992 | 2,0           | 9,5    | 10,5   | 12                  | 16,5           | 18,0   | 12,5   | 40     | 480   | 66          | 0,0         |
| <b>RM42B</b>                     | 8421078034032 | 18421078034039 | 2,4           | 9,2    | 10,6   | 12                  | 10,4           | 25,2   | 13,2   | 396    | 4752  | 170         | 0,0         |
| <b>RL87B</b>                     | 8421078032489 | 18421078032486 | 10,5          | 8,9    | 3,0    | 12                  | 17,2           | 25,3   | 9,1    | 324    | 3888  | 179         | 0,0         |
| <b>RS89B</b>                     | 8421078033332 | 18421078033339 | 8,5           | 15,0   | 3,5    | 12                  | 8,5            | 15,0   | 3,5    | 2800   | 33600 | 0           | 0,0         |
| <b>RM100B</b>                    | 8421078033134 | 18421078033131 | 10,0          | 8,0    | 1,2    | 12                  | 11,6           | 12,8   | 9,5    | 1020   | 12240 | 162         | 0,1         |
| <b>HAIR STRAIGHTENERS</b>        |               |                |               |        |        |                     |                |        |        |        |       |             |             |
| <b>JBPP1070</b>                  | 8421078036302 | 18421078036309 | 6,0           | 36,0   | 9,5    | 6                   | 21,5           | 37,0   | 20,0   | 96     | 576   | 175         | 0,6         |
| <b>JBPP1588</b>                  | 8421078039051 | 18421078039058 | 0,0           | 0,0    | 0,0    | 6                   | 0,0            | 0,0    | 0,0    | 0      | 0     | 0           |             |
| <b>JBPP5570</b>                  | 8421078038429 | 18421078038426 | 7,0           | 39,5   | 6,5    | 6                   | 25,5           | 41,5   | 23,0   | 63     | 378   | 176         | 1,0         |
| <b>JBSE2101</b>                  | 8421078036296 | 18421078036293 | 6,0           | 42,0   | 11,0   | 6                   | 20,0           | 43,0   | 24,0   | 70     | 420   | 180         | 0,8         |
| <b>PP1065</b>                    | 8421078035756 | 18421078035753 | 10,5          | 34,0   | 12,0   | 4                   | 23,5           | 35,0   | 27,0   | 60     | 240   | 177         | 1,1         |
| <b>HAIR DRYERS</b>               |               |                |               |        |        |                     |                |        |        |        |       |             |             |
| <b>JBCA1901</b>                  | 8421078036616 | 18421078036613 | 5,5           | 31,5   | 10,5   | 6                   | 24,0           | 33,0   | 19,0   | 80     | 480   | 167         | 0,5         |
| <b>JBSC1065</b>                  | 8421078036562 | 18421078036569 | 10,0          | 23,0   | 28,0   | 6                   | 30,5           | 62,0   | 25,5   | 24     | 144   | 168         | 1,0         |
| <b>JBSC1195</b>                  | 8421078038382 | 18421078038389 | 11,5          | 22,0   | 28,0   | 6                   | 37,0           | 45,5   | 31,0   | 24     | 144   | 163         | 1,2         |
| <b>JBSC1290</b>                  | 8421078039037 | 18421078039034 | 12,0          | 20,0   | 28,0   | 6                   | 0,0            | 0,0    | 0,0    | 0      | 0     | 0           | 1,0         |
| <b>JBSC1430</b>                  | 8421078037309 | 18421078037306 | 10,0          | 25,0   | 18,0   | 6                   | 32,5           | 38,5   | 27,0   | 45     | 270   | 178         | 0,9         |
| <b>JBSC1440</b>                  | 8421078039044 | 18421078039041 | 0,0           | 0,0    | 0,0    | 6                   | 0,0            | 0,0    | 0,0    | 0      | 0     | 0           |             |
| <b>JBSC2211</b>                  | 8421078037354 | 18421078037351 | 10,0          | 37,0   | 13,5   | 6                   | 29,5           | 39,5   | 32,5   | 40     | 240   | 173         | 0,7         |
| <b>JBSC5577</b>                  | 8421078038375 | 18421078038372 | 9,0           | 31,0   | 29,5   | 4                   | 33,0           | 37,5   | 31,0   | 30     | 120   | 170         | 1,4         |

| REFERENCE                    | EAN13         | ITF14          | UNIT BOX (cm) |        |        | UNITS PER PACKAGING | PACKAGING (cm) |        |        | PALLET |       |             | WEIGHT (Kg) |
|------------------------------|---------------|----------------|---------------|--------|--------|---------------------|----------------|--------|--------|--------|-------|-------------|-------------|
|                              |               |                | WIDTH         | LENGTH | HEIGHT |                     | WIDTH          | LENGTH | HEIGHT | BOXES  | UNITS | HEIGHT (cm) |             |
| <b>SC1013</b>                | 8421078027744 | 18421078027741 | 10,0          | 22,0   | 28,5   | 6                   | 33,0           | 46,0   | 30,0   | 25     | 150   | 180         | 1,0         |
| <b>SC43B</b>                 | 8421078035688 | 18421078035685 | 8,5           | 18,0   | 26,0   | 6                   | 28,0           | 38,0   | 28,0   | 40     | 240   | 155         | 0,7         |
| <b>SC47B</b>                 | 8421078034261 | 18421078034268 | 9,0           | 14,0   | 22,5   | 12                  | 38,0           | 44,0   | 25,0   | 24     | 288   | 171         | 0,5         |
| <b>SC56B</b>                 | 8421078033110 | 18421078033117 | 9,5           | 23,5   | 27,0   | 6                   | 31,0           | 48,0   | 29,0   | 30     | 180   | 170         | 0,9         |
| <b>SC67B</b>                 | 8421078033578 | 18421078033575 | 9,5           | 23,9   | 27,5   | 6                   | 30,8           | 49,3   | 30,0   | 30     | 180   | 165         | 1,0         |
| <b>JBT01430</b>              | 8421078037460 | 18421078037467 | 2,0           | 16,0   | 26,0   | 12                  | 17,5           | 29,5   | 19,5   | 112    | 1344  | 152         | 0,1         |
| <b>SEWING</b>                |               |                |               |        |        |                     |                |        |        |        |       |             |             |
| <b>AC45</b>                  | 8421078032328 | 18421078032325 | 4,5           | 35,5   | 22,0   | 4                   | 19,3           | 36,4   | 23,9   | 72     | 288   | 159         | 0,9         |
| <b>JSMC1120</b>              | 8421078038993 | 18421078038990 | -             | -      | -      | 1                   | -              | -      | -      | -      | -     | -           | -           |
| <b>JSMC5217</b>              | 8421078036432 | 8421078036432  | 20,0          | 39,0   | 34,0   | 1                   | 20,0           | 39,0   | 34,0   | 48     | 48    | 151         | 5,9         |
| <b>MC695</b>                 | 8421078028864 | 8421078028864  | 20,0          | 39,0   | 33,5   | 1                   | 20,0           | 39,0   | 33,5   | 60     | 60    | 180         | 5,9         |
| <b>MC740</b>                 | 8421078032182 | 8421078032182  | 21,5          | 43,0   | 35,5   | 1                   | 22,0           | 44,5   | 36,5   | 28     | 28    | 161         | 7,0         |
| <b>MC744</b>                 | 8421078033981 | 8421078033981  | 21,0          | 43,0   | 35,0   | 1                   | 22,5           | 44,5   | 36,0   | 28     | 28    | 157         | 7,0         |
| <b>MC823</b>                 | 8421078032168 | 8421078032168  | 26,0          | 46,0   | 35,5   | 1                   | 26,0           | 46,0   | 35,5   | 24     | 24    | 157         | 6,6         |
| <b>OL902</b>                 | 8421078033998 | 8421078033998  | 35,0          | 42,5   | 34,0   | 1                   | 36,0           | 43,2   | 35,0   | 18     | 18    | 141         | 8,2         |
| <b>ELECTRO</b>               |               |                |               |        |        |                     |                |        |        |        |       |             |             |
| <b>ELECTRIC RICE COOKERS</b> |               |                |               |        |        |                     |                |        |        |        |       |             |             |
| <b>AR393</b>                 | 8421078035480 | 18421078035487 | 24,5          | 24,5   | 21,0   | 4                   | 26,5           | 50,5   | 43,5   | 18     | 72    | 146         | 1,8         |
| <b>AR394</b>                 | 8421078035497 | 18421078035494 | 30,0          | 30,0   | 22,0   | 2                   | 32,0           | 61,5   | 24,0   | 20     | 40    | 139         | 2,6         |
| <b>AR395</b>                 | 8421078035503 | 18421078035500 | 34,0          | 34,0   | 26,0   | 2                   | 35,5           | 70,0   | 28,0   | 16     | 32    | 155         | 3,5         |
| <b>VACUUM CLEANERS</b>       |               |                |               |        |        |                     |                |        |        |        |       |             |             |
| <b>AP915</b>                 | 8421078035169 | 8421078035169  | 26,0          | 44,0   | 26,5   | 1                   | 26,0           | 44,0   | 26,5   | 36     | 36    | 171         | 4,8         |
| <b>RBA915</b>                | 8421078035183 | 18421078035180 | 13,5          | 17,0   | 4,5    | 30                  | 18,5           | 67,5   | 29,0   | 30     | 900   | 160         | 0,2         |
| <b>AP998</b>                 | 8421078035589 | 8421078035589  | 32,0          | 46,0   | 31,0   | 1                   | 32,0           | 46,0   | 31,0   | 30     | 30    | 175         | 6,6         |
| <b>AP999</b>                 | 8421078033158 | 8421078033158  | 27,0          | 37,0   | 27,0   | 1                   | 27,0           | 37,0   | 27,0   | 48     | 48    | 174         | 4,7         |
| <b>JEAP1629</b>              | 8421078038986 | 18421078038983 | 0,0           | 0,0    | 0,0    | 1                   | 0,0            | 0,0    | 0,0    | 0      | 0     | 0           |             |
| <b>JEAP1950</b>              | 8421078038597 | 18421078038594 | 13,0          | 27,0   | 67,0   | 1                   | 13,0           | 27,0   | 67,0   | 60     | 60    | 177         | 2,9         |
| <b>JEAP9300</b>              | 8421078036258 | 8421078036258  | 14,5          | 31,5   | 68,0   | 1                   | 14,5           | 31,5   | 68,0   | 45     | 45    | 173         | 3,4         |
| <b>KNEADERS</b>              |               |                |               |        |        |                     |                |        |        |        |       |             |             |
| <b>BT575</b>                 | 8421078033967 | 18421078033964 | 14,5          | 21,5   | 16,0   | 6                   | 44,0           | 45,0   | 17,5   | 30     | 180   | 150         | 1,5         |
| <b>FP500P</b>                | 8421078034292 | 18421078034299 | 27,0          | 38,0   | 35,5   | 2                   | 39,0           | 56,0   | 39,0   | 18     | 36    | 180         | 5,2         |
| <b>JEMA1240</b>              | 8421078038818 | 18421078038815 | 0,0           | 0,0    | 0,0    | 6                   | 0,0            | 0,0    | 0,0    | 0      | 0     | 0           |             |
| <b>JEMA1502</b>              | 8421078036937 | 18421078036934 | 24,5          | 40,0   | 36,0   | 2                   | 42,0           | 50,5   | 38,0   | 18     | 36    | 167         | 4,5         |
| <b>JEMA5502</b>              | 8421078037903 | 18421078037900 | 24,5          | 40,0   | 36,0   | 2                   | 42,0           | 50,5   | 38,0   | 18     | 36    | 168         | 5,5         |
| <b>MZ670</b>                 | 8421078034568 | 18421078034565 | 22,5          | 30,5   | 29,5   | 4                   | 32,0           | 46,5   | 61,0   | 10     | 40    | 137         | 2,5         |
| <b>MIXERS</b>                |               |                |               |        |        |                     |                |        |        |        |       |             |             |
| <b>BT126</b>                 | 8421078033240 | 18421078033247 | 7,0           | 8,5    | 35,5   | 9                   | 22,0           | 28,5   | 37,5   | 50     | 450   | 158         | 0,7         |
| <b>BT158</b>                 | 8421078033257 | 18421078033254 | 11,5          | 17,0   | 22,5   | 6                   | 19,0           | 36,5   | 46,5   | 36     | 216   | 155         | 1,0         |
| <b>BT159</b>                 | 8421078035374 | 18421078035371 | 9,0           | 19,5   | 23,5   | 6                   | 29,5           | 40,5   | 25,0   | 48     | 288   | 168         | 1,1         |
| <b>BT166</b>                 | 8421078035404 | 18421078035401 | 10,5          | 10,5   | 39,5   | 9                   | 33,5           | 32,5   | 42,5   | 24     | 216   | 145         | 1,0         |
| <b>BT169</b>                 | 8421078035411 | 18421078035418 | 20,5          | 22,5   | 20,0   | 6                   | 47,0           | 63,0   | 23,0   | 14     | 84    | 140         | 1,6         |
| <b>BT175</b>                 | 8421078034452 | 18421078034459 | 10,5          | 16,5   | 24,0   | 6                   | 33,0           | 35,0   | 26,5   | 45     | 270   | 180         | 1,0         |
| <b>BT176</b>                 | 8421078034728 | 18421078034725 | 10,0          | 10,0   | 39,5   | 6                   | 21,5           | 31,0   | 41,5   | 33     | 198   | 180         | 1,0         |
| <b>BT177</b>                 | 8421078034735 | 18421078034732 | 14,0          | 25,0   | 22,5   | 4                   | 28,0           | 51,0   | 25,0   | 36     | 144   | 165         | 1,4         |
| <b>BT185</b>                 | 8421078033639 | 18421078033636 | 10,5          | 10,5   | 45,0   | 6                   | 22,0           | 34,0   | 46,5   | 28     | 168   | 149         | 1,3         |
| <b>BT199</b>                 | 8421078033646 | 18421078033643 | 13,0          | 24,0   | 27,5   | 4                   | 28,5           | 49,5   | 29,0   | 30     | 120   | 160         | 1,8         |



| REFERENCE                     | EAN13         | ITF14          | UNIT BOX (cm) |        |        | UNITS PER PACKAGING | PACKAGING (cm) |        |        | PALLET |       |             | WEIGHT (Kg) |
|-------------------------------|---------------|----------------|---------------|--------|--------|---------------------|----------------|--------|--------|--------|-------|-------------|-------------|
|                               |               |                | WIDTH         | LENGTH | HEIGHT |                     | WIDTH          | LENGTH | HEIGHT | BOXES  | UNITS | HEIGHT (cm) |             |
| <b>BT5025</b>                 | 8421078035305 | 18421078035302 | 10,0          | 10,0   | 39,5   | 6                   | 21,0           | 31,0   | 41,0   | 44     | 264   | 179         | 1,0         |
| <b>JEBT1124</b>               | 8421078038788 | 18421078038785 | 8,0           | 7,5    | 39,5   | 9                   | 0,0            | 0,0    | 0,0    | 0      | 0     | 0           | 0,7         |
| <b>JEBT1788</b>               | 8421078038771 | 18421078038778 | 0,0           | 0,0    | 0,0    | 6                   | 0,0            | 0,0    | 0,0    | 0      | 0     | 0           |             |
| <b>JEBT1790</b>               | 8421078036890 | 18421078036897 | 13,0          | 24,5   | 22,5   | 4                   | 26,0           | 46,0   | 28,0   | 27     | 108   | 153         | 1,3         |
| <b>JEBT1791</b>               | 8421078038047 | 18421078038044 | 12,0          | 21,5   | 23,5   | 4                   | 26,0           | 45,0   | 25,5   | 36     | 144   | 168         | 1,2         |
| <b>JEBT1851</b>               | 8421078037095 | 18421078037092 | 10,0          | 10,0   | 43,0   | 6                   | 21,0           | 31,5   | 45,0   | 36     | 216   | 162         | 1,2         |
| <b>JEBT1852</b>               | 8421078037217 | 18421078037214 | 10,5          | 17,0   | 24,0   | 6                   | 33,0           | 35,5   | 26,5   | 45     | 270   | 180         | 1,0         |
| <b>JEBT1853</b>               | 8421078037972 | 18421078037979 | 10,5          | 16,5   | 24,0   | 6                   | 34,0           | 35,0   | 26,0   | 36     | 216   | 171         | 1,0         |
| <b>JEBT1855</b>               | 8421078038030 | 18421078038037 | 7,0           | 14,0   | 28,0   | 6                   | 15,5           | 45,0   | 30,0   | 60     | 360   | 165         | 1,0         |
| <b>JEBT1906</b>               | 8421078038764 | 18421078038761 | 7,0           | 7,0    | 37,0   | 9                   | 0,0            | 0,0    | 0,0    | 0      | 0     | 0           | 0,6         |
| <b>JEBT1945</b>               | 8421078036210 | 18421078036217 | 9,5           | 18,5   | 24,5   | 6                   | 32,0           | 40,0   | 28,0   | 40     | 240   | 175         | 1,3         |
| <b>JEBT5026</b>               | 8421078035749 | 18421078035746 | 13,0          | 24,5   | 27,0   | 4                   | 18,0           | 49,0   | 29,0   | 30     | 120   | 155         | 1,7         |
| <b>BLENDERS</b>               |               |                |               |        |        |                     |                |        |        |        |       |             |             |
| <b>BT1041</b>                 | 8421078033554 | 18421078033551 | 18,5          | 27,0   | 36,5   | 2                   | 28,0           | 38,0   | 38,0   | 32     | 64    | 167         | 4,3         |
| <b>BT1056</b>                 | 8421078035244 | 18421078035241 | 27,0          | 42,0   | 32,0   | 2                   | 43,5           | 56,0   | 34,5   | 10     | 20    | 127         | 5,6         |
| <b>BT265</b>                  | 8421078035077 | 18421078035074 | 16,5          | 31,0   | 23,0   | 4                   | 34,0           | 34,0   | 49,0   | 20     | 80    | 147         | 3,2         |
| <b>BT5030</b>                 | 8421078035336 | 18421078035333 | 17,5          | 34,0   | 23,5   | 2                   | 35,5           | 36,0   | 25,0   | 36     | 72    | 154         | 3,3         |
| <b>BT604N-1300W</b>           | 8421078034681 | 18421078034688 | 17,0          | 34,0   | 23,0   | 3                   | 35,0           | 52,0   | 25,0   | 24     | 72    | 155         | 3,6         |
| <b>BT609</b>                  | 8421078034582 | 18421078034589 | 19,0          | 18,5   | 42,5   | 4                   | 38,5           | 39,0   | 44,5   | 18     | 72    | 149         | 3,7         |
| <b>BT795</b>                  | 8421078035510 | 18421078035517 | 20,5          | 30,5   | 35,5   | 2                   | 32,0           | 43,0   | 38,5   | 24     | 48    | 169         | 3,9         |
| <b>BT797-1300W</b>            | 8421078034698 | 18421078034695 | 17,0          | 34,0   | 23,0   | 3                   | 36,0           | 52,0   | 25,5   | 24     | 72    | 153         | 3,6         |
| <b>BT800</b>                  | 8421078033042 | 18421078033049 | 21,2          | 22,7   | 44,5   | 2                   | 24,0           | 44,0   | 47,5   | 21     | 42    | 157         | 3,1         |
| <b>JEBT1001</b>               | 8421078037125 | 18421078037122 | 12,5          | 12,5   | 38,0   | 6                   | 27,5           | 39,5   | 40,0   | 36     | 216   | 175         | 1,2         |
| <b>JEBT1241</b>               | 8421078037705 | 18421078037702 | 21,5          | 39,5   | 28,0   | 2                   | 42,0           | 45,0   | 30,0   | 24     | 48    | 150         | 4,7         |
| <b>JEBT1243</b>               | 8421078038535 | 18421078038532 | 19,5          | 21,0   | 40,5   | 2                   | 22,0           | 40,5   | 43,0   | 0      | 0     | 0           | 3,0         |
| <b>JEBT1265</b>               | 8421078037699 | 18421078037696 | 16,5          | 31,5   | 23,5   | 4                   | 33,5           | 34,0   | 47,5   | 20     | 80    | 149         | 3,2         |
| <b>JEBT1500</b>               | 8421078036241 | 18421078036248 | 17,5          | 34,0   | 23,0   | 2                   | 36,0           | 35,0   | 25,0   | 36     | 72    | 159         | 3,5         |
| <b>ELECTRIC COFFEE MAKERS</b> |               |                |               |        |        |                     |                |        |        |        |       |             |             |
| <b>CA288N</b>                 | 8421078026006 | 18421078026003 | 15,0          | 21,5   | 27,5   | 6                   | 44,5           | 47,0   | 30,0   | 18     | 108   | 156         | 1,2         |
| <b>CA290</b>                  | 8421078032403 | 18421078032400 | 18,5          | 23,0   | 31,0   | 6                   | 48,0           | 57,0   | 33,0   | 15     | 90    | 159         | 1,5         |
| <b>CA390</b>                  | 8421078033592 | 18421078033599 | 19,5          | 29,5   | 33,5   | 4                   | 40,5           | 60,0   | 36,0   | 12     | 48    | 135         | 1,9         |
| <b>CA5040</b>                 | 8421078035312 | 18421078035319 | 15,0          | 21,0   | 28,0   | 6                   | 44,5           | 47,0   | 30,0   | 18     | 108   | 157         | 1,2         |
| <b>JECA1287</b>               | 8421078038078 | 18421078038075 | 15,5          | 18,5   | 25,0   | 6                   | 38,5           | 47,5   | 26,5   | 24     | 144   | 169         | 1,0         |
| <b>JECA1512</b>               | 8421078038863 | 18421078038860 | 0,0           | 0,0    | 0,0    | 6                   | 0,0            | 0,0    | 0,0    | 0      | 0     | 0           |             |
| <b>JECA1750</b>               | 8421078038658 | 18421078038655 | 17,0          | 21,0   | 27,0   | 6                   | 44,0           | 52,5   | 29,0   | 18     | 108   | 147         | 1,2         |
| <b>JECA1752</b>               | 8421078038672 | 18421078038679 | 17,0          | 21,0   | 27,0   | 6                   | 44,0           | 52,5   | 29,0   | 18     | 108   | 147         | 1,2         |
| <b>JECA1800</b>               | 8421078038870 | 18421078038877 | 0,0           | 0,0    | 0,0    | 4                   | 0,0            | 0,0    | 0,0    | 0      | 0     | 0           |             |
| <b>JECA2300</b>               | 8421078038092 | 18421078038099 | 19,0          | 36,5   | 34,0   | 2                   | 39,0           | 40,0   | 36,0   | 24     | 48    | 155         | 3,7         |
| <b>MILK WARMERS</b>           |               |                |               |        |        |                     |                |        |        |        |       |             |             |
| <b>CL819</b>                  | 8421078033776 | 18421078033773 | 21,0          | 20,5   | 23,5   | 4                   | 42,5           | 43,0   | 25,0   | 18     | 72    | 144         | 1,1         |
| <b>JECL1820</b>               | 8421078038085 | 18421078038082 | 13,0          | 17,0   | 19,5   | 6                   | 35,5           | 41,0   | 21,5   | 42     | 252   | 166         | 0,7         |
| <b>JECL1900</b>               | 8421078038146 | 18421078038143 | 14,5          | 14,5   | 17,5   | 6                   | 31,0           | 45,5   | 19,5   | 48     | 288   | 171         | 0,9         |
| <b>STEAM STATION</b>          |               |                |               |        |        |                     |                |        |        |        |       |             |             |
| <b>CP816</b>                  | 8421078031970 | 18421078031977 | 23,5          | 38,2   | 27,0   | 2                   | 39,1           | 48,3   | 29,8   | 24     | 48    | 158         | 4,4         |
| <b>CP830</b>                  | 8421078034544 | 18421078034541 | 22,5          | 40,5   | 29,0   | 2                   | 42,5           | 47,0   | 30,5   | 18     | 36    | 152         | 3,7         |
| <b>JECP8522</b>               | 8421078037057 | 18421078037054 | 26,5          | 27,5   | 37,0   | 2                   | 29,5           | 54,0   | 38,5   | 24     | 48    | 177         | 3,7         |
| <b>JECP8523</b>               | 8421078038108 | 18421078038105 | 22,0          | 41,0   | 28,0   | 2                   | 42,5           | 44,5   | 31,0   | 18     | 36    | 146         | 3,1         |
| <b>STEAM COOKERS</b>          |               |                |               |        |        |                     |                |        |        |        |       |             |             |
| <b>CV200</b>                  | 8421078029472 | 18421078029479 | 15,0          | 25,5   | 20,0   | 6                   | 27,5           | 47,0   | 42,0   | 18     | 108   | 141         | 1,1         |

| REFERENCE                                | EAN13         | ITF14          | UNIT BOX (cm) |        |        | UNITS PER PACKAGING | PACKAGING (cm) |        |        | PALLET |       |             | WEIGHT (Kg) |
|--|---------------|----------------|---------------|--------|--------|---------------------|----------------|--------|--------|--------|-------|-------------|-------------|
|  |               |                | WIDTH         | LENGTH | HEIGHT |                     | WIDTH          | LENGTH | HEIGHT | BOXES  | UNITS | HEIGHT (cm) |             |
| CV5020                                   | 8421078035282 | 18421078035289 | 15,0          | 26,0   | 20,0   | 6                   | 26,5           | 47,0   | 42,5   | 18     | 108   | 143         | 1,1         |
| CV623                                    | 8421078035213 | 18421078035210 | 28,0          | 38,0   | 26,0   | 2                   | 39,5           | 57,5   | 28,0   | 24     | 48    | 180         | 3,2         |
| <b>GAS COOKERS AND ELECTRIC KITCHENS</b> |               |                |               |        |        |                     |                |        |        |        |       |             |             |
| CE220                                    | 8421078032632 | 18421078032639 | 9,5           | 48,5   | 32,0   | 3                   | 29,5           | 49,5   | 34,0   | 24     | 72    | 151         | 4,1         |
| JECE1231                                 | 8421078037200 | 18421078037207 | 10,0          | 29,0   | 30,0   | 4                   | 31,0           | 41,5   | 32,0   | 30     | 120   | 175         | 2,2         |
| JECE1233                                 | 8421078038009 | 18421078038006 | 9,0           | 29,5   | 30,0   | 4                   | 30,0           | 39,0   | 31,0   | 30     | 120   | 170         | 2,3         |
| JECG2701                                 | 8421078037019 | 18421078037887 | 8,5           | 27,5   | 33,0   | 3                   | 27,0           | 28,0   | 35,0   | 40     | 120   | 155         | 1,5         |
| JECG2702                                 | 8421078037026 | 18421078037023 | 7,0           | 60,0   | 34,0   | 3                   | 24,0           | 61,0   | 35,5   | 20     | 60    | 161         | 2,6         |
| JECG2703                                 | 8421078037033 | 18421078037030 | 7,0           | 60,0   | 33,5   | 3                   | 25,0           | 61,5   | 35,0   | 20     | 60    | 159         | 3,1         |
| JECG2721                                 | 8421078039099 | 18421078039096 | 0,0           | 0,0    | 0,0    | 3                   | 0,0            | 0,0    | 0,0    | 0      | 0     | 0           |             |
| JEVI1460                                 | 8421078036920 | 18421078036927 | 11,5          | 60,5   | 39,5   | 2                   | 24,0           | 62,0   | 42,0   | 24     | 48    | 180         | 5,0         |
| JEVI1470                                 | 8421078038115 | 8421078038115  | 30,0          | 54,0   | 21,0   | 1                   | 30,5           | 55,5   | 23,0   | 35     | 35    | 176         | 6,2         |
| V139                                     | 8421078033547 | 18421078033544 | 7,0           | 29,5   | 36,5   | 4                   | 29,0           | 37,5   | 31,5   | 40     | 160   | 175         | 2,2         |
| V140                                     | 8421078031475 | 18421078031472 | 7,0           | 30,0   | 36,0   | 4                   | 30,0           | 38,0   | 32,0   | 40     | 160   | 175         | 2,1         |
| V141                                     | 8421078035367 | 18421078035364 | 8,0           | 51,0   | 31,5   | 3                   | 26,0           | 53,0   | 33,5   | 24     | 72    | 147         | 3,1         |
| V142                                     | 8421078032601 | 18421078032608 | 8,0           | 51,5   | 31,5   | 3                   | 27,0           | 53,0   | 33,5   | 24     | 72    | 147         | 3,2         |
| V531                                     | 8421078029571 | 18421078029578 | 10,5          | 31,5   | 37,0   | 4                   | 32,5           | 45,0   | 39,5   | 24     | 96    | 173         | 2,1         |
| V532                                     | 8421078029595 | 18421078029608 | 10,5          | 53,0   | 37,5   | 3                   | 33,0           | 55,5   | 40,0   | 18     | 54    | 180         | 3,6         |
| VIN145                                   | 8421078032878 | 18421078032875 | 6,5           | 32,0   | 41,0   | 3                   | 21,0           | 33,5   | 43,0   | 36     | 108   | 144         | 2,3         |
| <b>FOOD SLICERS</b>                      |               |                |               |        |        |                     |                |        |        |        |       |             |             |
| CF1053                                   | 8421078035053 | 18421078035050 | 28,5          | 41,5   | 28,5   | 2                   | 43,0           | 58,0   | 31,0   | 12     | 24    | 132         | 4,1         |
| JECF0300                                 | 8421078036234 | 18421078036231 | 12,5          | 37,0   | 24,5   | 4                   | 39,0           | 51,0   | 26,5   | 27     | 108   | 168         | 2,2         |
| JECF1200                                 | 8421078038580 | 18421078038587 | 26,5          | 39,0   | 28,5   | 2                   | 40,5           | 53,5   | 30,0   | 18     | 36    | 176         | 4,5         |
| JECF1820                                 | 8421078038641 | 18421078038648 | 10,5          | 36,5   | 22,0   | 4                   | 39,0           | 44,0   | 24,0   | 30     | 120   | 147         | 2,3         |
| <b>CREPE MAKER</b>                       |               |                |               |        |        |                     |                |        |        |        |       |             |             |
| JECR1000                                 | 8421078038139 | 18421078038136 | 7,5           | 31,5   | 32,5   | 6                   | 34,0           | 48,0   | 35,0   | 24     | 144   | 155         | 1,6         |
| <b>VACUUM SEALERS</b>                    |               |                |               |        |        |                     |                |        |        |        |       |             |             |
| EV1026                                   | 8421078029656 | 18421078029653 | 20,5          | 43,5   | 26,5   | 2                   | 43,0           | 45,5   | 29,5   | 18     | 36    | 152         | 3,5         |
| EV105                                    | 8421078029632 | 18421078029639 | 18,0          | 37,9   | 20,9   | 2                   | 37,8           | 39,1   | 22,8   | 42     | 84    | 175         | 2,7         |
| EV109                                    | 8421078033943 | 18421078033940 | 7,5           | 47,0   | 9,0    | 6                   | 23,5           | 48,5   | 20,0   | 49     | 294   | 155         | 0,8         |
| JEEV2210                                 | 8421078037187 | 18421078037184 | 7,0           | 44,5   | 11,0   | 6                   | 23,0           | 46,0   | 25,0   | 42     | 252   | 162         | 1,0         |
| JEEV2240                                 | 8421078038573 | 18421078038570 | 10,0          | 39,0   | 15,0   | 4                   | 21,5           | 41,5   | 32,5   | 50     | 200   | 180         | 1,3         |
| <b>VACUUM SEALERS SPARE PARTS</b>        |               |                |               |        |        |                     |                |        |        |        |       |             |             |
| B22X30                                   | 8421078029953 | 18421078029950 | 6,0           | 23,0   | 16,5   | 15                  | 31,5           | 50,5   | 26,0   | 24     | 360   | 171         | 0,7         |
| B28X40                                   | 8421078029977 | 18421078029974 | 6,0           | 29,0   | 22,0   | 15                  | 32,0           | 68,0   | 32,0   | 15     | 225   | 176         | 1,1         |
| R22X6                                    | 8421078029915 | 18421078029912 | 7,5           | 23,5   | 13,5   | 15                  | 38,0           | 43,0   | 26,0   | 24     | 360   | 171         | 0,6         |
| R28X6                                    | 8421078029939 | 18421078029936 | 7,5           | 29,5   | 14,0   | 15                  | 38,0           | 42,5   | 32,5   | 20     | 300   | 178         | 0,7         |
| R266                                     | 8421078032816 | 18421078032813 | 12,0          | 26,5   | 4,2    | 8                   | 16,3           | 26,5   | 12,9   | 133    | 1064  | 103         | 0,3         |
| <b>MILK FROTHER</b>                      |               |                |               |        |        |                     |                |        |        |        |       |             |             |
| JEES1111                                 | 8421078038320 | 18421078038327 | 7,0           | 7,0    | 27,0   | 8                   | 16,5           | 31,0   | 28,5   | 80     | 640   | 163         | 0,2         |
| <b>JUICERS</b>                           |               |                |               |        |        |                     |                |        |        |        |       |             |             |
| EX1044                                   | 8421078034483 | 18421078034480 | 22,0          | 22,0   | 32,0   | 4                   | 23,5           | 65,5   | 46,0   | 14     | 56    | 147         | 2,5         |
| EX1054                                   | 8421078035084 | 18421078035081 | 19,0          | 25,0   | 32,0   | 4                   | 26,0           | 66,0   | 39,0   | 16     | 64    | 146         | 1,9         |
| EX1057                                   | 8421078035398 | 18421078035395 | 23,5          | 26,0   | 33,5   | 4                   | 48,5           | 53,5   | 36,0   | 12     | 48    | 159         | 3,3         |
| EX2600M                                  | 8421078036043 | 18421078036040 | 22,5          | 22,5   | 32,0   | 4                   | 23,5           | 66,0   | 46,5   | 14     | 56    | 146         | 1,9         |
| EX296                                    | 8421078032564 | 18421078032561 | 16,0          | 16,5   | 20,0   | 8                   | 34,0           | 34,0   | 42,0   | 24     | 192   | 151         | 0,8         |
| EX421                                    | 8421078034650 | 18421078034657 | 15,0          | 16,0   | 20,5   | 8                   | 32,0           | 42,0   | 33,0   | 24     | 192   | 147         | 0,8         |
| EX613                                    | 8421078034643 | 18421078034640 | 22,5          | 22,5   | 30,0   | 4                   | 23,5           | 61,5   | 46,5   | 14     | 56    | 137         | 2,3         |
| JEEX1045                                 | 8421078036036 | 18421078036033 | 22,5          | 22,0   | 32,0   | 4                   | 24,0           | 66,0   | 46,5   | 14     | 56    | 145         | 1,9         |

| REFERENCE      | EAN13         | ITF14          | UNIT BOX (cm) |        |        | UNITS PER PACKAGING | PACKAGING (cm) |        |        | PALLET |       |             | WEIGHT (Kg) |
|----------------|---------------|----------------|---------------|--------|--------|---------------------|----------------|--------|--------|--------|-------|-------------|-------------|
|                |               |                | WIDTH         | LENGTH | HEIGHT |                     | WIDTH          | LENGTH | HEIGHT | BOXES  | UNITS | HEIGHT (cm) |             |
| JEEX1046       | 8421078036227 | 18421078036224 | 17,0          | 20,5   | 27,0   | 6                   | 28,5           | 52,0   | 43,0   | 18     | 108   | 143         | 1,6         |
| JEEX1058       | 8421078036364 | 18421078036361 | 20,0          | 19,5   | 30,0   | 6                   | 32,0           | 59,5   | 41,0   | 12     | 72    | 136         | 1,7         |
| JEEX1059       | 8421078036944 | 18421078036941 | 23,5          | 23,5   | 32,0   | 4                   | 50,0           | 48,5   | 34,0   | 15     | 60    | 161         | 2,1         |
| JEEX1155       | 8421078038177 | 18421078038174 | 19,0          | 24,5   | 32,0   | 4                   | 33,5           | 51,0   | 39,5   | 18     | 72    | 168         | 2,0         |
| JEEX1422       | 8421078037132 | 18421078037139 | 16,5          | 19,5   | 26,0   | 8                   | 35,0           | 40,5   | 54,5   | 18     | 144   | 179         | 1,1         |
| JEEX1423       | 8421078038191 | 18421078038198 | 15,0          | 16,0   | 20,0   | 8                   | 32,0           | 41,5   | 34,0   | 30     | 240   | 180         | 0,8         |
| JEEX1549       | 8421078038801 | 18421078038808 | 0,0           | 0,0    | 0,0    | 6                   | 0,0            | 0,0    | 0,0    | 0      | 0     | 0           |             |
| JEEX1712       | 8421078038542 | 18421078038549 | 17,0          | 17,0   | 27,0   | 6                   | 28,0           | 51,5   | 34,5   | 24     | 144   | 153         | 1,2         |
| <b>FRYERS</b>  |               |                |               |        |        |                     |                |        |        |        |       |             |             |
| FR115          | 8421078033356 | 18421078033353 | 24,0          | 30,0   | 23,5   | 4                   | 25,5           | 61,0   | 49,5   | 12     | 48    | 137         | 2,1         |
| FR278          | 8421078031000 | 18421078031007 | 30,0          | 32,0   | 22,5   | 4                   | 34,0           | 62,0   | 46,0   | 10     | 40    | 139         | 2,8         |
| FR326E         | 8421078021742 | 18421078021749 | 19,0          | 32,5   | 23,0   | 4                   | 34,0           | 39,0   | 48,5   | 18     | 72    | 161         | 2,7         |
| FR5600         | 8421078035787 | 18421078035784 | 19,0          | 32,0   | 23,0   | 4                   | 33,5           | 39,0   | 49,0   | 18     | 72    | 162         | 2,7         |
| FR678          | 8421078034889 | 18421078034886 | 24,5          | 42,5   | 25,0   | 2                   | 44,0           | 50,0   | 27,5   | 18     | 36    | 147         | 2,8         |
| FR680          | 8421078034896 | 18421078034893 | 24,0          | 42,5   | 25,0   | 2                   | 44,5           | 50,0   | 27,5   | 18     | 36    | 165         | 2,9         |
| FR700          | 8421078030775 | 18421078030772 | 24,5          | 40,5   | 38,5   | 2                   | 42,0           | 51,0   | 40,5   | 16     | 32    | 180         | 4,2         |
| JEFR1221       | 8421078036265 | 18421078036262 | 26,0          | 26,0   | 30,0   | 2                   | 27,5           | 54,0   | 31,5   | 30     | 60    | 173         | 3,3         |
| JEFR1222       | 8421078036661 | 18421078036668 | 25,0          | 25,0   | 34,0   | 2                   | 26,5           | 52,0   | 36,0   | 24     | 48    | 161         | 2,7         |
| JEFR1223       | 8421078037224 | 18421078037221 | 25,0          | 25,0   | 33,5   | 2                   | 26,0           | 52,0   | 36,0   | 24     | 48    | 169         | 2,6         |
| JEFR1224       | 8421078037170 | 18421078037177 | 33,0          | 32,5   | 36,0   | 2                   | 35,0           | 66,0   | 36,0   | 12     | 24    | 159         | 3,8         |
| JEFR1225       | 8421078036654 | 18421078036651 | 33,0          | 33,0   | 36,5   | 2                   | 35,0           | 68,0   | 39,0   | 12     | 24    | 171         | 4,3         |
| JEFR1226       | 8421078037385 | 18421078037382 | 33,0          | 32,5   | 35,0   | 2                   | 34,5           | 66,5   | 37,0   | 12     | 24    | 165         | 4,1         |
| JEFR1227       | 8421078037668 | 18421078037665 | 35,0          | 35,0   | 32,0   | 2                   | 37,0           | 72,0   | 33,0   | 15     | 30    | 180         | 4,3         |
| JEFR1228       | 8421078037446 | 18421078037446 | 40,0          | 46,0   | 34,5   | 1                   | 41,0           | 47,0   | 36,5   | 18     | 18    | 156         | 8,9         |
| JEFR1229       | 8421078037712 | 18421078037719 | 31,0          | 31,0   | 35,0   | 2                   | 33,0           | 64,0   | 36,5   | 15     | 30    | 180         | 4,4         |
| JEFR1230       | 8421078038313 | 18421078038310 | 32,0          | 36,0   | 35,5   | 2                   | 38,0           | 66,0   | 37,0   | 12     | 24    | 165         | 4,9         |
| JEFR1242       | 8421078038757 | 18421078038754 | 0,0           | 0,0    | 0,0    | 1                   | 0,0            | 0,0    | 0,0    | 0      | 0     | 0           |             |
| JEFR1270       | 8421078038665 | 18421078038662 | 32,0          | 40,5   | 31,0   | 2                   | 46,0           | 66,5   | 33,5   | 10     | 20    | 148         | 6,0         |
| JEFR1816       | 8421078039129 | 18421078039126 | 0,0           | 0,0    | 0,0    | 1                   | 0,0            | 0,0    | 0,0    | 0      | 0     | 0           |             |
| JEFR5392       | 8421078037392 | 18421078037399 | 25,0          | 25,0   | 34,0   | 2                   | 27,0           | 52,0   | 36,5   | 24     | 48    | 161         | 2,7         |
| JESA2090       | 8421078037682 | 18421078037689 | 21,0          | 21,0   | 11,0   | 4                   | 23,0           | 44,5   | 24,0   | 42     | 168   | 159         | 0,7         |
| <b>KETTLES</b> |               |                |               |        |        |                     |                |        |        |        |       |             |             |
| HA547          | 8421078032014 | 18421078032011 | 12,0          | 16,5   | 18,5   | 6                   | 34,0           | 37,5   | 21,0   | 42     | 252   | 179         | 0,6         |
| HA701          | 8421078032977 | 18421078032974 | 14,5          | 19,0   | 21,0   | 6                   | 40,5           | 45,5   | 23,5   | 28     | 168   | 175         | 0,9         |
| HA702          | 8421078033912 | 18421078033919 | 13,5          | 20,0   | 21,0   | 6                   | 41,5           | 42,0   | 22,5   | 30     | 180   | 146         | 0,9         |
| JEHA1038       | 8421078037194 | 18421078037191 | 15,0          | 20,5   | 21,5   | 6                   | 42,5           | 45,0   | 23,0   | 28     | 168   | 180         | 0,9         |
| JEHA1040       | 8421078038160 | 18421078038167 | 16,5          | 20,5   | 23,0   | 6                   | 35,0           | 63,0   | 25,0   | 24     | 144   | 155         | 1,0         |
| JEHA1240       | 8421078038825 | 18421078038822 | 0,0           | 0,0    | 0,0    | 8                   | 0,0            | 0,0    | 0,0    | 0      | 0     | 0           |             |
| JEHA1575       | 8421078038849 | 18421078038846 | 0,0           | 0,0    | 0,0    | 6                   | 0,0            | 0,0    | 0,0    | 0      | 0     | 0           |             |
| JEHA1723       | 8421078038023 | 18421078038020 | 19,0          | 19,0   | 24,0   | 6                   | 40,0           | 59,5   | 26,5   | 24     | 144   | 174         | 1,0         |
| JEHA1808       | 8421078039136 | 18421078039133 | 0,0           | 0,0    | 0,0    | 6                   | 0,0            | 0,0    | 0,0    | 0      | 0     | 0           |             |
| JEHA1809       | 8421078038832 | 18421078038839 | 0,0           | 0,0    | 0,0    | 6                   | 0,0            | 0,0    | 0,0    | 0      | 0     | 0           |             |
| <b>OVENS</b>   |               |                |               |        |        |                     |                |        |        |        |       |             |             |
| HN916          | 8421078033677 | 8421078033677  | 34,5          | 44,5   | 28,5   | 1                   | 34,5           | 44,5   | 28,5   | 25     | 25    | 158         | 5,0         |
| HN921          | 8421078033684 | 8421078033684  | 36,5          | 50,0   | 32,0   | 1                   | 36,5           | 50,0   | 32,0   | 20     | 20    | 178         | 6,8         |
| HN928          | 8421078033691 | 8421078033691  | 42,0          | 53,0   | 34,5   | 1                   | 42,0           | 53,0   | 34,5   | 16     | 16    | 180         | 8,3         |
| HN936          | 8421078033714 | 8421078033714  | 42,5          | 55,5   | 37,0   | 1                   | 42,5           | 55,5   | 37,0   | 16     | 16    | 163         | 10,1        |
| HN945          | 8421078033721 | 8421078033721  | 44,0          | 61,0   | 40,0   | 1                   | 44,0           | 61,0   | 40,0   | 12     | 12    | 149         | 12,0        |



| REFERENCE                                    | EAN13         | ITF14          | UNIT BOX (cm) |        |        | UNITS PER PACKAGING | PACKAGING (cm) |        |        | PALLET |       |             | WEIGHT (Kg) |
|--|---------------|----------------|---------------|--------|--------|---------------------|----------------|--------|--------|--------|-------|-------------|-------------|
|  |               |                | WIDTH         | LENGTH | HEIGHT |                     | WIDTH          | LENGTH | HEIGHT | BOXES  | UNITS | HEIGHT (cm) |             |
| <b>HN966</b>                                 | 8421078033738 | 8421078033738  | 47,0          | 69,0   | 44,5   | 1                   | 47,0           | 69,0   | 44,5   | 6      | 6     | 148         | 15,1        |
| <b>JEHN0910</b>                              | 8421078036012 | 18421078036019 | 32,5          | 41,0   | 26,5   | 2                   | 42,0           | 67,0   | 28,0   | 16     | 32    | 180         | 4,2         |
| <b>MILKER</b>                                |               |                |               |        |        |                     |                |        |        |        |       |             |             |
| <b>JELV2300</b>                              | 8421078038450 | 18421078038457 | 12,5          | 13,0   | 28,5   | 4                   | 29,0           | 28,5   | 32,0   | 40     | 160   | 159         | 0,7         |
| <b>JELV2350</b>                              | 8421078038443 | 18421078038440 | 12,5          | 19,5   | 28,5   | 4                   | 29,0           | 42,0   | 32,5   | 30     | 120   | 178         | 1,4         |
| <b>JEEM2450</b>                              | 8421078039075 | 18421078039072 | 0,0           | 0,0    | 0,0    |                     | 0,0            | 0,0    | 0,0    | 0      | 0     | 0           | 0           |
| <b>JUICE EXTRACTOR</b>                       |               |                |               |        |        |                     |                |        |        |        |       |             |             |
| <b>JELI1201</b>                              | 8421078036357 | 18421078036354 | 15,0          | 21,0   | 31,0   | 4                   | 32,5           | 43,5   | 33,0   | 30     | 120   | 180         | 1,9         |
| <b>JELI1580</b>                              | 8421078037538 | 18421078037535 | 19,5          | 30,5   | 31,0   | 4                   | 40,0           | 63,0   | 33,5   | 12     | 48    | 141         | 2,5         |
| <b>GRINDERS</b>                              |               |                |               |        |        |                     |                |        |        |        |       |             |             |
| <b>ML132</b>                                 | 8421078033806 | 18421078034534 | 10,0          | 11,0   | 18,5   | 6                   | 24,0           | 33,0   | 19,5   | 77     | 462   | 159         | 0,7         |
| <b>ML133-6</b>                               | 8421078033530 | 18421078035234 | 10,5          | 11,0   | 18,5   | 6                   | 23,5           | 33,0   | 20,0   | 77     | 462   | 159         | 0,9         |
| <b>JEML1150</b>                              | 8421078039112 | 18421078039119 | 0,0           | 0,0    | 0,0    | 6                   | 0,0            | 0,0    | 0,0    | 0      | 0     | 0           | 0           |
| <b>SLOW COOKER</b>                           |               |                |               |        |        |                     |                |        |        |        |       |             |             |
| <b>JEOL2135</b>                              | 8421078036531 | 18421078036538 | 25,0          | 33,5   | 34,0   | 2                   | 34,5           | 51,5   | 36,0   | 18     | 36    | 170         | 4,7         |
| <b>JEOL2145</b>                              | 8421078036548 | 18421078036545 | 23,5          | 36,0   | 36,0   | 2                   | 37,5           | 48,0   | 38,0   | 18     | 36    | 173         | 5,7         |
| <b>ELECTRIC PAELLA PANS</b>                  |               |                |               |        |        |                     |                |        |        |        |       |             |             |
| <b>JEPE1639</b>                              | 8421078037729 | 18421078037726 | 12,0          | 42,0   | 44,0   | 2                   | 25,0           | 43,0   | 46,0   | 18     | 36    | 152         | 4,3         |
| <b>PE550</b>                                 | 8421078033325 | 8421078033325  | 13,5          | 56,0   | 56,0   | 1                   | 15,5           | 66,0   | 66,5   | 16     | 16    | 148         | 7,7         |
| <b>PE640</b>                                 | 8421078035473 | 18421078035470 | 14,5          | 40,5   | 40,5   | 2                   | 30,0           | 41,0   | 42,0   | 18     | 36    | 180         | 4,0         |
| <b>POPCORN MAKER</b>                         |               |                |               |        |        |                     |                |        |        |        |       |             |             |
| <b>PAL97</b>                                 | 8421078035565 | 18421078035562 | 14,5          | 22,5   | 25,5   | 6                   | 45,5           | 47,0   | 28,0   | 18     | 108   | 152         | 1,0         |
| <b>CHOPPERS</b>                              |               |                |               |        |        |                     |                |        |        |        |       |             |             |
| <b>PC123N</b>                                | 8421078033394 | 18421078033391 | 17,0          | 17,5   | 27,0   | 6                   | 36,5           | 52,5   | 29,0   | 24     | 144   | 174         | 1,7         |
| <b>JEPC1250</b>                              | 8421078036883 | 18421078036880 | 21,0          | 31,0   | 17,5   | 4                   | 33,0           | 43,5   | 35,0   | 24     | 96    | 155         | 2,3         |
| <b>JEPC1251</b>                              | 8421078037675 | 18421078037672 | 21,0          | 31,0   | 17,0   | 4                   | 32,5           | 44,0   | 35,0   | 24     | 96    | 155         | 2,3         |
| <b>ELECTRIC GRILLS, BARBECUES AND GRILLS</b> |               |                |               |        |        |                     |                |        |        |        |       |             |             |
| <b>AC266</b>                                 | 8421078032465 | 18421078032462 | 7,0           | 34,0   | 24,4   | 4                   | 30,0           | 35,7   | 26,5   | 45     | 180   | 164         | 1,2         |
| <b>BQ101</b>                                 | 8421078022343 | 18421078022340 | 8,0           | 43,5   | 27,0   | 4                   | 28,0           | 44,5   | 34,0   | 30     | 120   | 180         | 1,8         |
| <b>BQ101R</b>                                | 8436584382218 | 8436584382218  | 8,5           | 44,0   | 28,0   | 1                   | 8,5            | 44,0   | 28,0   | 90     | 90    | 155         | 1,9         |
| <b>BQ108</b>                                 | 8421078035541 | 18421078035548 | 7,5           | 40,5   | 36,0   | 4                   | 32,5           | 42,0   | 38,0   | 24     | 96    | 167         | 2,1         |
| <b>BQ95</b>                                  | 8421078033233 | 18421078033230 | 8,5           | 45,0   | 31,0   | 4                   | 33,0           | 36,0   | 47,5   | 18     | 72    | 158         | 2,0         |
| <b>EBQ2</b>                                  | 8421078035558 | 18421078035555 | 11,5          | 56,0   | 31,5   | 3                   | 36,0           | 57,5   | 33,0   | 16     | 48    | 151         | 3,4         |
| <b>GR1100</b>                                | 8421078021285 | 18421078021282 | 18,5          | 40,5   | 40,0   | 2                   | 39,0           | 42,0   | 42,0   | 24     | 48    | 183         | 5,4         |
| <b>GR195R</b>                                | 8421078036180 | 8421078036180  | 12,5          | 59,0   | 32,0   | 1                   | 12,5           | 59,0   | 32,0   | 55     | 55    | 175         | 3,0         |
| <b>GR204N</b>                                | 8421078030850 | 18421078030857 | 9,5           | 58,0   | 33,5   | 4                   | 40,0           | 60,0   | 36,5   | 16     | 64    | 161         | 2,8         |
| <b>GR205</b>                                 | 8421078029854 | 18421078029851 | 7,0           | 38,0   | 23,0   | 6                   | 38,5           | 44,0   | 24,5   | 27     | 162   | 147         | 1,5         |
| <b>GR217</b>                                 | 8421078034773 | 18421078034770 | 9,5           | 60,0   | 34,5   | 4                   | 40,0           | 62,0   | 36,5   | 16     | 64    | 161         | 2,5         |
| <b>GR2600</b>                                | 8421078035534 | 18421078035531 | 13,5          | 66,0   | 36,0   | 2                   | 29,0           | 67,5   | 38,5   | 16     | 32    | 149         | 3,8         |
| <b>GR266</b>                                 | 8421078029731 | 18421078029738 | 13,5          | 34,5   | 24,5   | 2                   | 29,0           | 35,0   | 26,0   | 45     | 90    | 160         | 1,7         |
| <b>GR3000</b>                                | 8421078033813 | 18421078033810 | 14,0          | 69,5   | 41,0   | 2                   | 30,0           | 71,0   | 43,0   | 12     | 24    | 157         | 4,6         |
| <b>GR5500</b>                                | 8421078035343 | 18421078035340 | 9,0           | 49,5   | 33,0   | 2                   | 20,0           | 51,0   | 34,5   | 28     | 56    | 166         | 1,9         |
| <b>GR555A</b>                                | 8421078026532 | 18421078026539 | 9,0           | 56,5   | 29,5   | 6                   | 27,3           | 57,3   | 59,6   | 12     | 72    | 135         | 3,1         |
| <b>GR557A</b>                                | 8421078029991 | 18421078029998 | 9,0           | 56,5   | 30,0   | 6                   | 28,0           | 57,5   | 60,0   | 12     | 72    | 135         | 3,0         |
| <b>GR558</b>                                 | 8421078032649 | 18421078032646 | 9,0           | 56,5   | 29,5   | 6                   | 28,3           | 57,3   | 60,3   | 12     | 72    | 134         | 3,1         |
| <b>GR558R</b>                                | 8436584382195 | 8436584382195  | 12,0          | 60,0   | 35,6   | 1                   | 12,0           | 60,0   | 35,6   | 40     | 40    | 157         | 3,4         |
| <b>GR559</b>                                 | 8421078030607 | 18421078030604 | 29,4          | 56,5   | 9,1    | 2                   | 19,4           | 57,2   | 31,0   | 32     | 64    | 137         | 6,1         |

| REFERENCE      | EAN13         | ITF14         | UNIT BOX (cm) |        |        | UNITS PER PACKAGING | PACKAGING (cm) |        |        | PALLET |       |             | WEIGHT (Kg) |
|----------------|---------------|---------------|---------------|--------|--------|---------------------|----------------|--------|--------|--------|-------|-------------|-------------|
|                |               |               | WIDTH         | LENGTH | HEIGHT |                     | WIDTH          | LENGTH | HEIGHT | BOXES  | UNITS | HEIGHT (cm) |             |
| GR559R         | 8421078034667 | 8421078034667 | 10,0          | 54,5   | 29,0   | 1                   | 13,0           | 60,0   | 34,0   | 50     | 50    | 147         | 6,1         |
| GR594          | 8421078034421 | 8421078034428 | 16,5          | 39,0   | 38,0   | 4                   | 41,0           | 67,5   | 40,0   | 12     | 48    | 179         | 3,3         |
| GR603          | 8421078032267 | 8421078032264 | 12,5          | 73,0   | 40,0   | 2                   | 27,0           | 74,5   | 41,5   | 16     | 32    | 180         | 4,2         |
| GR608          | 8421078033615 | 8421078033612 | 13,5          | 65,0   | 35,5   | 3                   | 36,5           | 67,5   | 43,0   | 10     | 30    | 150         | 4,1         |
| GR669          | 8421078034285 | 8421078034282 | 29,4          | 55,0   | 10,2   | 2                   | 21,7           | 56,0   | 31,5   | 28     | 56    | 140         | 6,2         |
| GR669R         | 8421078034285 | 8421078034711 | 29,4          | 55,0   | 10,2   | 1                   | 13,5           | 59,7   | 32,8   | 40     | 40    | 147         | 6,2         |
| GT402          | 8421078030058 | 8421078030065 | 33,5          | 29,2   | 16,2   | 3                   | 35,5           | 49,6   | 30,9   | 20     | 60    | 154         | 4,9         |
| JEBQ0301AB     | 8421078035824 | 8421078035824 | 8,5           | 43,0   | 27,5   | 4                   | 28,0           | 44,5   | 33,5   | 30     | 120   | 180         | 1,8         |
| JEBQ1001       | 8421078035992 | 8421078035999 | 14,0          | 53,0   | 43,0   | 4                   | 54,5           | 57,5   | 45,5   | 6      | 24    | 152         | 5,2         |
| JEBQ1002       | 8421078036166 | 8421078036163 | 24,5          | 53,0   | 39,0   | 2                   | 50,5           | 54,5   | 41,5   | 6      | 12    | 167         | 7,0         |
| JEGR0550       | 8421078037293 | 8421078037290 | 10,0          | 56,5   | 30,0   | 4                   | 41,0           | 57,0   | 31,0   | 16     | 64    | 139         | 3,1         |
| JEGR1105       | 8421078037163 | 8421078037160 | 11,0          | 30,5   | 24,5   | 6                   | 32,0           | 35,0   | 52,0   | 18     | 108   | 171         | 1,4         |
| JEGR1106       | 8421078037156 | 8421078037153 | 11,5          | 30,5   | 25,0   | 6                   | 32,0           | 35,5   | 52,0   | 18     | 108   | 171         | 1,5         |
| JEGR1107       | 8421078037989 | 8421078037986 | 10,0          | 27,5   | 26,5   | 6                   | 30,0           | 63,0   | 30,0   | 20     | 120   | 175         | 1,5         |
| JEGR1124       | 8421078039204 | 8421078039201 | 0,0           | 0,0    | 0,0    | 6                   | 0,0            | 0,0    | 0,0    | 0      | 0     | 0           |             |
| JEGR1241       | 8421078038931 | 8421078038938 | 0,0           | 0,0    | 0,0    | 4                   | 0,0            | 0,0    | 0,0    | 0      | 0     | 0           |             |
| JEGR1450       | 8421078038917 | 8421078038914 | 0,0           | 0,0    | 0,0    | 2                   | 0,0            | 0,0    | 0,0    | 0      | 0     | 0           |             |
| JEGR1595       | 8421078036913 | 8421078036910 | 17,0          | 37,0   | 38,5   | 2                   | 36,0           | 39,0   | 40,5   | 24     | 48    | 177         | 3,7         |
| JEGR1596       | 8421078038924 | 8421078038921 | 0,0           | 0,0    | 0,0    | 2                   | 0,0            | 0,0    | 0,0    | 0      | 0     | 0           |             |
| JEGR1603       | 8421078038122 | 8421078038129 | 10,0          | 71,5   | 38,5   | 2                   | 21,0           | 73,0   | 40,5   | 20     | 40    | 177         | 4,2         |
| JEGR1913       | 8421078036906 | 8421078036903 | 17,0          | 37,0   | 38,0   | 2                   | 35,0           | 39,0   | 40,0   | 24     | 48    | 177         | 3,5         |
| JEGR2851       | 8421078036388 | 8421078036385 | 13,5          | 65,5   | 36,5   | 2                   | 28,5           | 67,5   | 38,0   | 16     | 32    | 149         | 3,8         |
| JEGR5522       | 8421078037484 | 8421078037481 | 7,0           | 35,5   | 22,5   | 6                   | 37,0           | 44,0   | 23,5   | 28     | 168   | 180         | 1,4         |
| JEPR0001       | 8421078035961 | 8421078035968 | 8,5           | 57,0   | 58,0   | 6                   | 28,0           | 58,0   | 61,0   | 12     | 72    | 134         | 3,0         |
| JT950          | 8421078033509 | 8421078033506 | 8,7           | 56,1   | 29,2   | 6                   | 27,5           | 57,3   | 60,0   | 12     | 72    | 135         | 3,2         |
| SET266         | 8421078032496 | 8421078032493 | 24,0          | 34,0   | 20,0   | 2                   | 35,0           | 41,7   | 25,7   | 36     | 72    | 170         | 3,0         |
| <b>IRONING</b> |               |               |               |        |        |                     |                |        |        |        |       |             |             |
| JEPL1221       | 8421078038337 | 8421078038334 | 12,5          | 30,0   | 16,0   | 6                   | 32,0           | 39,0   | 33,0   | 30     | 180   | 170         | 1,2         |
| JEPL2241       | 8421078038962 | 8421078038969 | 0,0           | 0,0    | 0,0    | 6                   | 0,0            | 0,0    | 0,0    | 0      | 0     | 0           |             |
| JEPL2401       | 8421078038948 | 8421078038945 | 0,0           | 0,0    | 0,0    | 6                   | 0,0            | 0,0    | 0,0    | 0      | 0     | 0           |             |
| JEPL3242       | 8421078039013 | 8421078039010 | 0,0           | 0,0    | 0,0    | 6                   | 0,0            | 0,0    | 0,0    | 0      | 0     | 0           |             |
| JEPL5215       | 8421078036418 | 8421078036415 | 12,5          | 30,0   | 15,5   | 6                   | 31,5           | 39,0   | 34,0   | 24     | 144   | 151         | 1,2         |
| JEPL7000       | 8421078036272 | 8421078036279 | 12,5          | 16,5   | 28,5   | 4                   | 26,0           | 34,5   | 30,5   | 45     | 180   | 168         | 1,2         |
| PL1028         | 8421078031734 | 8421078031731 | 15,0          | 32,5   | 17,0   | 6                   | 33,0           | 46,5   | 36,0   | 20     | 120   | 159         | 1,7         |
| PL1036         | 8421078033066 | 8421078033063 | 13,5          | 33,5   | 18,0   | 6                   | 35,0           | 41,0   | 39,5   | 24     | 144   | 173         | 1,6         |
| PL1058C        | 8421078035381 | 8421078035388 | 13,5          | 32,0   | 17,5   | 6                   | 33,5           | 42,0   | 36,5   | 24     | 144   | 163         | 1,6         |
| PL120          | 8421078033486 | 8421078033483 | 15,0          | 12,0   | 33,0   | 6                   | 26,0           | 45,0   | 35,0   | 24     | 144   | 155         | 1,0         |
| PL221C         | 8421078033493 | 8421078033490 | 12,5          | 30,5   | 16,0   | 6                   | 32,0           | 38,5   | 33,5   | 24     | 144   | 149         | 1,2         |
| PL225          | 8421078034841 | 8421078034848 | 13,0          | 30,5   | 14,5   | 6                   | 32,0           | 40,0   | 31,5   | 30     | 180   | 170         | 1,1         |
| PL501N         | 8421078032571 | 8421078032578 | 13,5          | 31,0   | 17,5   | 6                   | 32,0           | 42,0   | 35,5   | 24     | 144   | 161         | 1,7         |
| PL598C         | 8421078035428 | 8421078035425 | 12,5          | 31,5   | 17,0   | 6                   | 32,5           | 40,5   | 34,5   | 24     | 144   | 153         | 1,3         |
| PL615C         | 8421078034599 | 8421078034596 | 14,5          | 34,5   | 16,0   | 6                   | 35,0           | 44,5   | 34,5   | 20     | 120   | 153         | 1,5         |
| PL618          | 8421078032397 | 8421078032394 | 12,5          | 31,0   | 16,0   | 6                   | 32,0           | 39,5   | 34,5   | 24     | 144   | 153         | 1,4         |
| PL622C         | 8421078035435 | 8421078035432 | 14,0          | 32,0   | 17,0   | 6                   | 33,0           | 43,0   | 35,0   | 24     | 144   | 157         | 1,6         |
| PL357N         | 8421078027041 | 8421078030192 | 10,0          | 19,0   | 10,0   | 12                  | 32,0           | 40,0   | 23,5   | 42     | 504   | 169         | 0,7         |
| JEPL2810       | 8421078037101 | 8421078037108 | 9,5           | 21,5   | 10,5   | 10                  | 23,5           | 50,5   | 23,5   | 49     | 490   | 176         | 0,8         |

| REFERENCE              | EAN13          | ITF14           | UNIT BOX (cm) |        |        | UNITS PER PACKAGING | PACKAGING (cm) |        |        | PALLET |       |             | WEIGHT (Kg) |
|------------------------|----------------|-----------------|---------------|--------|--------|---------------------|----------------|--------|--------|--------|-------|-------------|-------------|
|                        |                |                 | WIDTH         | LENGTH | HEIGHT |                     | WIDTH          | LENGTH | HEIGHT | BOXES  | UNITS | HEIGHT (cm) |             |
| <b>LINT SHAVERS</b>    |                |                 |               |        |        |                     |                |        |        |        |       |             |             |
| JEQP5218               | 8421078036449  | 18421078036446  | 7,0           | 9,0    | 17,0   | 12                  | 24,0           | 30,0   | 19,5   | 72     | 864   | 156         | 0,2         |
| JEQP6688               | 8421078038979  | 18421078038976  | 7,0           | 8,0    | 14,0   | 12                  | 0,0            | 0,0    | 0,0    | 0      | 0     | 0           | 0,2         |
| QP398N                 | 8421078033011  | 18421078033018  | 7,0           | 8,5    | 17,0   | 12                  | 24,0           | 29,5   | 20,0   | 72     | 864   | 159         | 0,2         |
| QP620                  | 8421078030942  | 18421078030949  | 10,0          | 12,5   | 21,5   | 12                  | 39,5           | 44,0   | 22,0   | 30     | 360   | 147         | 0,5         |
| <b>SANDWICH MAKERS</b> |                |                 |               |        |        |                     |                |        |        |        |       |             |             |
| JESW1231               | 8421078036715  | 18421078036712  | 9,0           | 25,0   | 24,0   | 6                   | 26,0           | 28,5   | 50,0   | 36     | 216   | 171         | 1,2         |
| JESW1232               | 8421078036982  | 18421078036989  | 9,0           | 25,0   | 24,0   | 6                   | 26,0           | 28,5   | 50,0   | 36     | 216   | 174         | 1,2         |
| JESW1551               | 8421078038214  | 18421078038211  | 11,5          | 27,5   | 35,0   | 4                   | 29,5           | 47,5   | 37,0   | 24     | 96    | 163         | 2,2         |
| SW546                  | 8421078032007  | 18421078032004  | 13,5          | 31,0   | 36,5   | 4                   | 33,0           | 55,0   | 38,5   | 20     | 80    | 175         | 2,7         |
| SW551                  | 8421078035466  | 18421078035463  | 11,5          | 27,5   | 35,0   | 4                   | 29,0           | 47,0   | 36,5   | 24     | 96    | 163         | 2,3         |
| <b>TOASTERS</b>        |                |                 |               |        |        |                     |                |        |        |        |       |             |             |
| JETT0201               | 8421078035985  | 18421078035982  | 7,0           | 34,0   | 19,5   | 6                   | 35,0           | 43,5   | 21,5   | 30     | 180   | 146         | 0,9         |
| JETT1048               | 8421078038894  | 18421078038891  | 15,0          | 28,0   | 18,5   | 6                   | 0,0            | 0,0    | 0,0    | 0      | 0     | 0           | 1,2         |
| JETT1262               | 8421078038900  | 18421078038907  | 0,0           | 0,0    | 0,0    | 6                   | 0,0            | 0,0    | 0,0    | 0      | 0     | 0           |             |
| JETT1579               | 8421078037927  | 18421078037924  | 13,0          | 39,0   | 18,0   | 4                   | 27,0           | 41,0   | 38,5   | 32     | 128   | 169         | 1,4         |
| JETT1584               | 8421078038696  | 18421078038693  | 15,5          | 39,5   | 18,0   | 4                   | 32,0           | 40,5   | 38,0   | 24     | 96    | 167         | 1,6         |
| JETT1585               | 8421078038207  | 18421078038204  | 15,0          | 39,0   | 18,0   | 4                   | 33,5           | 41,0   | 38,0   | 24     | 96    | 169         | 1,6         |
| JETT1587               | 8421078037996  | 18421078037993  | 7,0           | 39,0   | 23,5   | 6                   | 40,5           | 43,5   | 25,5   | 24     | 144   | 177         | 1,1         |
| JETT1588               | 8421078038436  | 18421078038433  | 7,5           | 43,5   | 25,5   | 6                   | 45,5           | 47,0   | 27,0   | 18     | 108   | 153         | 1,3         |
| TT1043                 | 8421078033929  | 18421078033926  | 15,0          | 42,0   | 19,5   | 4                   | 32,0           | 43,5   | 41,5   | 18     | 72    | 161         | 1,7         |
| TT1046                 | 8421078033936  | 18421078033933  | 19,5          | 42,0   | 19,5   | 4                   | 41,0           | 44,0   | 41,5   | 12     | 48    | 141         | 2,1         |
| TT331                  | 8421078029397  | 18421078029394  | 16,0          | 26,5   | 18,5   | 8                   | 33,5           | 54,0   | 38,0   | 18     | 144   | 176         | 1,1         |
| TT5015                 | 8421078035299  | 18421078035296  | 15,6          | 27,6   | 19,5   | 6                   | 28,7           | 48,0   | 40,5   | 24     | 144   | 178         | 1,1         |
| TT5016                 | 8421078035794  | 18421078035791  | 9,0           | 47,5   | 32,5   | 4                   | 37,5           | 48,0   | 35,0   | 18     | 72    | 159         | 2,0         |
| TT579                  | 8421078034476  | 18421078034473  | 13,0          | 39,0   | 18,0   | 4                   | 27,0           | 41,0   | 38,0   | 32     | 128   | 169         | 1,4         |
| TT587                  | 8421078032540  | 18421078032547  | 7,0           | 39,0   | 23,5   | 6                   | 41,0           | 43,5   | 26,0   | 24     | 144   | 179         | 1,1         |
| TT588                  | 8421078031932  | 18421078031939  | 7,5           | 41,0   | 25,0   | 6                   | 42,5           | 47,0   | 27,5   | 24     | 144   | 180         | 1,3         |
| TT589                  | 84210780305897 | 184210780305894 | 7,0           | 39,0   | 24,0   | 6                   | 41,0           | 43,5   | 26,0   | 24     | 144   | 180         | 1,5         |
| TT589NG                | 8421078034001  | 18421078034008  | 9,5           | 36,5   | 26,0   | 6                   | 38,0           | 58,0   | 28,5   | 20     | 120   | 158         | 1,5         |
| TT591                  | 8421078035350  | 18421078035357  | 9,5           | 47,5   | 32,5   | 4                   | 38,5           | 48,0   | 35,0   | 18     | 72    | 161         | 2,0         |
| TT631                  | 8421078035039  | 18421078035036  | 16,0          | 26,5   | 18,5   | 8                   | 32,5           | 54,5   | 38,0   | 18     | 144   | 177         | 1,1         |
| TT632                  | 8421078035442  | 18421078035449  | 21,5          | 47,0   | 23,5   | 2                   | 45,0           | 48,5   | 25,5   | 18     | 36    | 150         | 2,9         |
| <b>AIR</b>             |                |                 |               |        |        |                     |                |        |        |        |       |             |             |
| HU992                  | 8421078032410  | 18421078032417  | 10,5          | 10,5   | 14,0   | 8                   | 22,5           | 43,0   | 17,0   | 63     | 504   | 168         | 0,4         |
| HU996                  | 8421078035770  | 18421078035777  | 18,5          | 19,0   | 40,5   | 4                   | 38,5           | 38,5   | 42,5   | 18     | 72    | 143         | 1,6         |
| JEHU2413               | 8421078039402  | 18421078039409  | 0,0           | 0,0    | 0,0    | 1                   | 0,0            | 0,0    | 0,0    | 0      | 0     | 0           |             |
| JEHU2420               | 8421078039143  | 18421078039140  | 0,0           | 0,0    | 0,0    | 1                   | 0,0            | 0,0    | 0,0    | 0      | 0     | 0           |             |
| JEHU5408               | 8421078037408  | 18421078037405  | 17,0          | 17,5   | 21,5   | 4                   | 36,5           | 36,0   | 24,0   | 36     | 144   | 160         | 0,5         |
| JEGA1001               | 8421078035817  | 18421078035817  | 16,5          | 79,5   | 16,0   | 1                   | 17,0           | 80,5   | 18,0   | 63     | 63    | 177         | 3,8         |
| <b>YOGURT MAKERS</b>   |                |                 |               |        |        |                     |                |        |        |        |       |             |             |
| JEYG2266               | 8421078037118  | 18421078037115  | 25,0          | 25,0   | 13,5   | 4                   | 27,0           | 51,5   | 28,5   | 30     | 120   | 160         | 1,9         |
| JREC2266               | 8421078037378  | 18421078037375  | 8,0           | 23,0   | 9,0    | 15                  | 25,0           | 42,0   | 29,0   | 24     | 360   | 180         | 0,4         |

| REFERENCE         | EAN13         | ITF14         | UNIT BOX (cm) |        |        | UNITS PER PACKAGING | PACKAGING (cm) |        |        | PALLET |       |             | WEIGHT (Kg) |
|-------------------|---------------|---------------|---------------|--------|--------|---------------------|----------------|--------|--------|--------|-------|-------------|-------------|
|                   |               |               | WIDTH         | LENGTH | HEIGHT |                     | WIDTH          | LENGTH | HEIGHT | BOXES  | UNITS | HEIGHT (cm) |             |
| <b>HOME</b>       |               |               |               |        |        |                     |                |        |        |        |       |             |             |
| <b>ACCESORIES</b> |               |               |               |        |        |                     |                |        |        |        |       |             |             |
| AC1               | 8436584380382 | 8436584380389 | 11,0          | 9,0    | 41,0   | 12                  | 27,2           | 42,0   | 10,2   | 96     | 1152  | 148         | 0,1         |
| AC2               | 8436017660159 | 8436017660156 | 3,5           | 10,0   | 37,0   | 12                  | 23,0           | 39,0   | 8,2    | 120    | 1440  | 138         | 0,1         |
| AC21              | 8436584380436 | 8436584380433 | 24,0          | 10,0   | 4,0    | 12                  | 21,0           | 25,0   | 11,0   | 72     | 864   | 160         | 0,1         |
| AC22              | 8436584380443 | 8436584380440 | 3,2           | 7,5    | 26,2   | 12                  | 17,0           | 27,0   | 12,0   | 112    | 1344  | 99          | 0,1         |
| AC23              | 8436584380450 | 8436584380457 | 24,5          | 8,0    | 3,5    | 12                  | 15,0           | 26,0   | 11,0   | 144    | 1728  | 113         | 0,1         |
| AC24              | 8436584380467 | 8436584380464 | 22,5          | 9,0    | 3,0    | 12                  | 20,0           | 25,5   | 11,5   | 144    | 1728  | 141         | 0,1         |
| AC26              | 8436584380481 | 8436584380488 | 5,5           | 8,5    | 32,5   | 12                  | 16,0           | 34,0   | 13,0   | 96     | 1152  | 125         | 0,1         |
| AC28              | 8436584380504 | 8436584380501 | 3,0           | 8,0    | 23,5   | 12                  | 16,0           | 24,5   | 11,0   | 126    | 1512  | 114         | 0,1         |
| AC29              | 8436017660272 | 8436017660279 | 2,8           | 8,0    | 25,0   | 12                  | 16,2           | 26,2   | 10,0   | 168    | 2016  | 147         | 0,1         |
| AC3               | 8436017660166 | 8436017660163 | 4,5           | 10,5   | 37,6   | 12                  | 24,8           | 39,5   | 8,2    | 120    | 1440  | 163         | 0,1         |
| AC30              | 8436584380528 | 8436584380525 | 3,5           | 10,0   | 32,0   | 12                  | 26,5           | 33,0   | 8,5    | 120    | 1440  | 155         | 0,1         |
| AC31              | 8436584380535 | 8436584380532 | 3,5           | 10,0   | 32,0   | 12                  | 26,0           | 33,0   | 8,0    | 128    | 1536  | 165         | 0,1         |
| AC32              | 8436584380542 | 8436584380549 | 3,5           | 8,0    | 32,0   | 12                  | 26,4           | 32,2   | 8,1    | 128    | 1536  | 165         | 0,1         |
| AC33              | 8436584380559 | 8436584380556 | 3,0           | 8,5    | 30,5   | 12                  | 16,0           | 32,0   | 9,5    | 144    | 1728  | 135         | 0,1         |
| AC34              | 8436584380207 | 8436584380204 | 3,0           | 8,0    | 29,2   | 12                  | 16,5           | 31,5   | 10,0   | 160    | 1920  | 145         | 0,1         |
| AC35              | 8436584380214 | 8436584380211 | 3,5           | 8,0    | 31,0   | 12                  | 15,5           | 32,5   | 12,5   | 96     | 1152  | 111         | 0,1         |
| AC36              | 8436584380221 | 8436584380228 | 1,0           | 10,5   | 26,5   | 12                  | 12,0           | 28,0   | 17,0   | 128    | 1536  | 135         | 0,1         |
| AC37              | 8436584381051 | 8436584381058 | 2,0           | 8,0    | 27,0   | 12                  | 16,0           | 28,0   | 8,5    | 256    | 3072  | 145         | 0,1         |
| AC38              | 8436584381068 | 8436584381065 | 2,0           | 10,5   | 30,0   | 12                  | 21,5           | 31,0   | 8,5    | 192    | 2304  | 149         | 0,1         |
| AC4               | 8436017660173 | 8436017660170 | 3,0           | 10,5   | 36,5   | 12                  | 18,8           | 40,0   | 7,7    | 405    | 4860  | 177         | 0,1         |
| AC40              | 8436584380689 | 8436584380686 | 4,0           | 13,3   | 29,9   | 12                  | 29,0           | 29,0   | 22,5   | 60     | 720   | 160         | 0,3         |
| AC5               | 8436584380429 | 8436584380426 | 4,2           | 12,0   | 37,2   | 12                  | 24,0           | 39,5   | 8,0    | 120    | 1440  | 135         | 0,1         |
| AC50              | 8436017660371 | 8436017660378 | 16,5          | 32,8   | 9,0    | 6                   | 29,2           | 33,5   | 35,0   | 32     | 192   | 158         | 0,9         |
| AC51              | 8436584380313 | 8436584380310 | 8,0           | 10,0   | 22,5   | 6                   | 21,0           | 25,0   | 25,0   | 72     | 432   | 165         | 0,3         |
| AC52              | 8436017660586 | 8436017660583 | 20,0          | 20,0   | 16,1   | 6                   | 21,6           | 41,8   | 50,8   | 28     | 168   | 179         | 0,8         |
| AC54              | 8436584380344 | 8436584380341 | 10,0          | 10,0   | 27,0   | 6                   | 22,0           | 32,0   | 29,0   | 55     | 330   | 160         | 0,5         |
| AC56              | 8436017660623 | 8436017660620 | 7,4           | 24,2   | 18,5   | 6                   | 24,6           | 25,6   | 40,0   | 60     | 360   | 175         | 0,6         |
| AC57E             | 8436584380375 | 8436584380198 | 11,0          | 13,0   | 13,0   | 9                   | 36,0           | 41,5   | 15,5   | 54     | 486   | 159         | 0,3         |
| ARA30             | 8436584381235 | 8436584381232 | 6,0           | 18,0   | 30,0   | 12                  | 38,5           | 38,5   | 32,5   | 30     | 360   | 178         | 0,1         |
| HACC4301          | 8436584383819 | 8436584383816 | 7,5           | 7,5    | 35,0   | 12                  | 20,5           | 35,5   | 16,5   | 96     | 1152  | 173         | 0,1         |
| HACC4303          | 8436584383833 | 8436584383830 | 2,0           | 8,5    | 37,0   | 12                  | 12,5           | 39,0   | 10,0   | 216    | 2592  | 132         | 0,1         |
| HACC4304          | 8436584383840 | 8436584383847 | 5,0           | 10,0   | 38,5   | 12                  | 9,5            | 39,5   | 12,5   | 312    | 3744  | 178         | 0,1         |
| HACC4305          | 8436584383857 | 8436584383854 | 5,0           | 9,5    | 39,0   | 12                  | 10,5           | 40,0   | 13,5   | 192    | 2304  | 135         | 0,1         |
| HACC4306          | 8436584383864 | 8436584383861 | 9,0           | 10,0   | 34,0   | 12                  | 10,0           | 42,5   | 17,0   | 120    | 1440  | 143         | 0,1         |
| HACC4307          | 8436584383871 | 8436584383878 | 5,0           | 10,5   | 39,5   | 12                  | 12,0           | 40,0   | 15,5   | 120    | 1440  | 135         | 0,1         |
| HACC4500          | 8436584382041 | 8436584382048 | 2,0           | 12,0   | 40,0   | 12                  | 13,0           | 40,5   | 19,5   | 96     | 1152  | 132         | 0,2         |
| HACC4502          | 8436584383796 | 8436584383793 | 12,0          | 24,0   | 35,5   | 6                   | 38,5           | 49,5   | 37,0   | 18     | 108   | 162         | 1,6         |
| HACC4503          | 8436584383802 | 8436584383809 | 3,5           | 37,0   | 23,0   | 6                   | 26,0           | 39,0   | 23,0   | 63     | 378   | 174         | 0,8         |
| HACC4504          | 8436584383925 | 8436584383922 | 12,0          | 15,0   | 35,5   | 6                   | 32,0           | 37,5   | 37,0   | 32     | 192   | 163         | 1,1         |
| HACC4520          | 8436584382263 | 8436584382260 | 22,0          | 10,0   | 3,5    | 12                  | 20,0           | 26,0   | 11,0   | 144    | 1728  | 141         | 0,1         |
| HACC4521          | 8436584382751 | 8436584382758 | 2,0           | 7,0    | 33,0   | 12                  | 24,0           | 35,0   | 6,5    | 216    | 2592  | 171         | 0,1         |
| HACC4522          | 8436584384373 | 8436584384370 | 2,0           | 10,0   | 32,0   | 12                  | 7,5            | 28,0   | 34,5   | 120    | 1440  | 155         | 0,2         |
| HACC4524          | 8436584385189 | 8436584385186 | 0,0           | 0,0    | 0,0    | 6                   | 0,0            | 0,0    | 0,0    | 0      | 0     | 0           |             |
| HACC4530          | 8436584383062 | 8436584383069 | 3,5           | 26,0   | 27,5   | 12                  | 28,5           | 48,0   | 29,0   | 30     | 360   | 160         | 0,2         |
| HACC4531          | 8436584383161 | 8436584383168 | 2,0           | 23,5   | 36,5   | 6                   | 9,0            | 37,5   | 24,5   | 135    | 810   | 150         | 0,7         |
| HACC4533          | 8436584383260 | 8436584383267 | 30,5          | 26,0   | 3,5    | 6                   | 26,0           | 30,5   | 10,5   | 150    | 900   | 180         | 0,2         |

| REFERENCE      | EAN13         | ITF14          | UNIT BOX (cm) |        |        | UNITS PER PACKAGING | PACKAGING (cm) |        |        | PALLET |       |             | WEIGHT (Kg) |
|----------------|---------------|----------------|---------------|--------|--------|---------------------|----------------|--------|--------|--------|-------|-------------|-------------|
|                |               |                | WIDTH         | LENGTH | HEIGHT |                     | WIDTH          | LENGTH | HEIGHT | BOXES  | UNITS | HEIGHT (cm) |             |
| HACC4534       | 8436584383703 | 18436584383700 | 2,0           | 18,0   | 34,0   | 6                   | 18,0           | 34,5   | 11,5   | 72     | 432   | 84          | 0,2         |
| HACC4535       | 8436584383727 | 18436584383724 | 8,0           | 8,5    | 14,0   | 6                   | 18,5           | 27,0   | 16,5   | 128    | 768   | 147         | 0,1         |
| HACC4536       | 8436584383734 | 18436584383731 | 10,0          | 10,0   | 16,0   | 6                   | 22,0           | 32,5   | 18,0   | 72     | 432   | 159         | 0,2         |
| HACC4537       | 8436584383741 | 18436584383748 | 13,0          | 13,0   | 18,0   | 6                   | 28,0           | 40,5   | 20,5   | 48     | 288   | 140         | 0,3         |
| HACC4539       | 8436584384397 | 18436584384394 | 7,0           | 7,0    | 17,0   | 10                  | 16,5           | 37,5   | 19,0   | 98     | 980   | 148         | 0,4         |
| HACC4540       | 8436584384816 | 18436584384813 | 3,5           | 12,0   | 20,5   | 12                  | 22,0           | 26,0   | 22,0   | 84     | 1008  | 152         | 0,2         |
| HACC4541       | 8436584383789 | 18436584383786 | 5,5           | 7,0    | 24,5   | 12                  | 23,0           | 46,0   | 14,0   | 77     | 924   | 164         | 0,2         |
| HACC4542       | 8436584383666 | 18436584383663 | 5,0           | 11,0   | 30,0   | 6                   | 16,5           | 23,0   | 31,5   | 72     | 432   | 155         | 0,3         |
| HACC4543       | 8436584383673 | 18436584383670 | 5,0           | 5,0    | 30,0   | 12                  | 17,0           | 21,5   | 31,5   | 90     | 1080  | 170         | 0,2         |
| HACC4545       | 8436584384465 | 18436584384462 | 7,0           | 7,0    | 18,5   | 12                  | 24,5           | 30,0   | 21,0   | 72     | 864   | 159         | 0,2         |
| HACC4546       | 8436584384809 | 18436584384806 | 1,0           | 17,0   | 20,0   | 12                  | 13,0           | 20,0   | 23,0   | 154    | 1848  | 176         | 0,1         |
| HACC4554       | 8436584384441 | 18436584384448 | 22,5          | 22,5   | 15,5   | 6                   | 24,0           | 46,5   | 49,0   | 21     | 126   | 162         | 0,4         |
| HACC4600       | 8436584382669 | 18436584382666 | 11,0          | 13,5   | 33,0   | 6                   | 29,0           | 36,0   | 35,0   | 32     | 192   | 155         | 1,0         |
| HACC4624       | 8436584385080 | 18436584385087 | -             | -      | -      | 6                   | -              | -      | -      | -      | -     | -           | -           |
| HACC5453       | 8436584384236 | 18436584384233 | 4,0           | 26,0   | 27,5   | 12                  | 28,0           | 48,5   | 28,5   | 30     | 360   | 160         | 0,2         |
| HACC5460       | 8436584384151 | 18436584384158 | 12,0          | 11,5   | 37,0   | 6                   | 26,0           | 37,0   | 39,0   | 36     | 216   | 171         | 0,8         |
| HCON5401       | 8436584384847 | 18436584384844 | 8,0           | 9,0    | 38,5   | 12                  | 12,5           | 47,0   | 11,0   | 144    | 1728  | 147         | 0,1         |
| HCON5402       | 8436584384854 | 18436584384851 | 5,0           | 11,0   | 39,5   | 12                  | 13,0           | 40,0   | 12,5   | 120    | 1440  | 0           | 0,1         |
| HCON5403       | 8436584384861 | 18436584384868 | 6,0           | 8,5    | 39,0   | 12                  | 12,5           | 40,0   | 11,5   | 144    | 1728  | 147         | 0,1         |
| HCON5404       | 8436584384878 | 18436584384875 | 3,0           | 8,5    | 31,0   | 12                  | 15,5           | 32,5   | 12,5   | 128    | 1536  | 139         | 0,1         |
| HCON5405       | 8436584384915 | 18436584384912 | 3,0           | 10,0   | 23,0   | 12                  | 20,5           | 25,0   | 10,5   | 132    | 1584  | 141         | 0,1         |
| HCON5406       | 8436584384922 | 18436584384929 | 1,0           | 10,5   | 27,0   | 12                  | 12,0           | 28,5   | 17,5   | 154    | 1848  | 155         | 0,1         |
| HCON5407       | 8436584384939 | 18436584384936 | 2,0           | 8,0    | 27,0   | 12                  | 16,0           | 27,5   | 9,0    | 128    | 1536  | 143         | 0,1         |
| HMAQ4501       | 8436584381488 | 18436584381485 | 10,5          | 13,5   | 13,0   | 6                   | 11,5           | 29,0   | 41,0   | 72     | 432   | 153         | 0,3         |
| HMAQ4502       | 8436584381495 | 18436584381492 | 10,5          | 32,5   | 11,5   | 6                   | 24,5           | 33,5   | 34,5   | 36     | 216   | 153         | 0,6         |
| HMAQ4503       | 8436584381501 | 18436584381508 | 8,0           | 39,5   | 17,0   | 6                   | 18,5           | 48,5   | 41,5   | 30     | 180   | 161         | 0,8         |
| HMAQ4504       | 8436584382065 | 18436584382062 | 11,0          | 14,5   | 28,5   | 6                   | 24,0           | 29,5   | 45,5   | 35     | 210   | 163         | 0,8         |
| HMAQ4505       | 8436584382560 | 18436584382567 | 20,0          | 21,0   | 17,0   | 6                   | 22,5           | 42,0   | 53,5   | 28     | 168   | 180         | 0,9         |
| HMAQ4506       | 8436584384274 | 18436584384271 | 13,0          | 13,5   | 15,0   | 6                   | 29,0           | 41,5   | 17,0   | 54     | 324   | 173         | 0,4         |
| HMAQ4508       | 8436584384304 | 18436584384301 | 8,5           | 9,0    | 10,0   | 12                  | 29,5           | 37,5   | 12,5   | 96     | 1152  | 165         | 0,1         |
| HMAQ4557       | 8436584384557 | 18436584384554 | 10,0          | 13,5   | 13,0   | 12                  | 22,5           | 43,0   | 28,5   | 42     | 504   | 170         | 0,3         |
| HRAC4535       | 8436584383758 | 18436584383755 | 1,5           | 12,5   | 19,0   | 24                  | 13,5           | 37,5   | 21,0   | 90     | 2160  | 141         | 0,0         |
| HRAC4536       | 8436584383765 | 18436584383762 | 2,0           | 12,5   | 19,0   | 18                  | 13,5           | 37,5   | 21,5   | 90     | 1620  | 153         | 0,1         |
| HRAC4537       | 8436584383772 | 18436584383779 | 3,0           | 12,5   | 19,0   | 12                  | 12,5           | 39,5   | 22,5   | 126    | 1512  | 173         | 0,1         |
| HSET1234       | 8436584384212 | 18436584384219 | 10,5          | 26,0   | 28,0   | 6                   | 34,0           | 54,0   | 30,5   | 24     | 144   | 177         | 0,9         |
| T16            | 8436584380276 | 18436584380273 | 4,5           | 22,0   | 26,0   | 6                   | 22,0           | 23,0   | 25,0   | 72     | 432   | 158         | 0,3         |
| T20            | 8436584380283 | 18436584380280 | 5,0           | 26,0   | 31,0   | 6                   | 26,0           | 26,0   | 25,0   | 60     | 360   | 171         | 0,5         |
| T26            | 8436584380290 | 18436584380297 | 5,0           | 31,5   | 36,0   | 6                   | 32,0           | 32,0   | 25,0   | 50     | 300   | 173         | 0,7         |
| <b>IRONING</b> |               |                |               |        |        |                     |                |        |        |        |       |             |             |
| 800            | 8436017650785 | 18436017650782 | 3,5           | 17,8   | 36,3   | 24                  | 18,2           | 54,0   | 45,6   | 24     | 576   | 152         | 0,1         |
| BRD1           | 8436584380573 | 18436584380570 | 17,5          | 28,3   | 2,3    | 12                  | 19,0           | 25,5   | 21,5   | 96     | 1152  | 142         | 0,1         |
| HFUN8014       | 8436584383154 | 18436584383151 | 4,5           | 23,5   | 36,5   | 6                   | 24,5           | 31,0   | 27,5   | 50     | 300   | 180         | 0,2         |
| HPLA0500       | 8436017659245 | 18436584382437 | 6,5           | 37,0   | 143,0  | 6                   | 45,0           | 42,5   | 151,0  | 4      | 24    | 177         | 5,4         |
| HPLA5210       | 8436584382768 | 18436584382765 | 28,0          | 17,0   | 2,0    | 12                  | 17,0           | 24,0   | 26,0   | 98     | 1176  | 162         | 0,1         |
| HPLA5211       | 8436584382775 | 18436584382772 | 2,5           | 18,0   | 21,5   | 12                  | 19,5           | 38,0   | 18,0   | 96     | 1152  | 166         | 0,1         |
| HPLA5212       | 8436584382782 | 18436584382789 | 10,0          | 18,5   | 21,0   | 6                   | 21,0           | 34,0   | 39,5   | 48     | 288   | 151         | 0,2         |
| HPLA8000       | 8436584381525 | 18436584381522 | 2,5           | 18,0   | 16,5   | 12                  | 21,0           | 38,5   | 18,5   | 96     | 1152  | 166         | 0,1         |
| HPLA8020       | 8436584382096 | 18436584382093 | 10,0          | 18,5   | 21,0   | 6                   | 21,0           | 34,0   | 39,5   | 28     | 168   | 151         | 0,2         |



| REFERENCE                                 | EAN13         | ITF14          | UNIT BOX (cm) |        |        | UNITS PER PACKAGING | PACKAGING (cm) |        |        | PALLET |       |             | WEIGHT (Kg) |
|---|---------------|----------------|---------------|--------|--------|---------------------|----------------|--------|--------|--------|-------|-------------|-------------|
|   |               |                | WIDTH         | LENGTH | HEIGHT |                     | WIDTH          | LENGTH | HEIGHT | BOXES  | UNITS | HEIGHT (cm) |             |
| <b>HPLA8110</b>                           | 8436584382072 | 18436584382079 | 0,5           | 15,0   | 28,0   | 12                  | 17,0           | 29,5   | 9,0    | 240    | 2880  | 168         | 0,1         |
| <b>HPLA8115</b>                           | 8436584382089 | 18436584382086 | 7,0           | 10,0   | 33,5   | 6                   | 11,0           | 62,5   | 24,0   | 60     | 360   | 159         | 0,7         |
| <b>HRF81</b>                              | 8436584381662 | 18436584381669 | 6,0           | 23,0   | 34,0   | 6                   | 36,5           | 23,0   | 29,0   | 50     | 300   | 160         | 0,3         |
| <b>PT10</b>                               | 8436584380580 | 18436584380587 | 0,5           | 17,0   | 26,5   | 12                  | 19,0           | 24,5   | 11,0   | 112    | 1344  | 90          | 0,0         |
| <b>RF50</b>                               | 8436017659290 | 18436017659297 | 6,0           | 22,0   | 33,0   | 6                   | 24,5           | 40,0   | 29,2   | 50     | 300   | 160         | 0,3         |
| <b>RF52</b>                               | 8436017659306 | 18436017659303 | 6,0           | 23,0   | 35,0   | 6                   | 24,0           | 39,0   | 30,0   | 50     | 300   | 162         | 0,3         |
| <b>RF55</b>                               | 8436017659313 | 18436017659310 | 23,0          | 34,5   | 6,0    | 6                   | 23,5           | 36,3   | 29,3   | 50     | 300   | 162         | 0,3         |
| <b>RF60</b>                               | 8436584383888 |                | 6,0           | 26,0   | 37,5   |                     |                |        |        |        |       | 0           | 0,3         |
| <b>RF8N</b>                               | 8436017658569 | 18436017658566 | 5,0           | 23,5   | 35,5   | 6                   | 25,0           | 34,0   | 26,0   | 54     | 324   | 167         | 0,3         |
| <b>RF8S</b>                               | 8436017658576 | 18436017658573 | 5,0           | 22,5   | 36,0   | 6                   | 25,0           | 33,0   | 26,0   | 54     | 324   | 162         | 0,3         |
| <b>BODY ANALYZERS</b>                     |               |                |               |        |        |                     |                |        |        |        |       |             |             |
| <b>523</b>                                | 8436584380597 | 18436584380594 | 4,2           | 32,8   | 30,7   | 6                   | 28,0           | 34,1   | 32,7   | 32     | 192   | 178         | 1,6         |
| <b>531</b>                                | 8436017658088 | 18436017658085 | 3,5           | 29,0   | 29,5   | 6                   | 23,0           | 30,5   | 31,5   | 48     | 288   | 141         | 1,4         |
| <b>532</b>                                | 8436584380184 | 18436584380181 | 3,5           | 29,0   | 29,5   | 6                   | 23,0           | 30,5   | 31,5   | 48     | 288   | 141         | 1,4         |
| <b>538</b>                                | 8436584380603 | 18436584380600 | 3,5           | 30,5   | 26,0   | 4                   | 16,5           | 32,5   | 28,0   | 70     | 280   | 155         | 1,3         |
| <b>577</b>                                | 8436017658095 | 18436017658092 | 4,0           | 28,5   | 35,5   | 6                   | 31,0           | 37,0   | 25,0   | 40     | 240   | 170         | 1,3         |
| <b>593</b>                                | 8436584380153 | 18436584380150 | 3,5           | 32,0   | 32,5   | 6                   | 24,0           | 34,0   | 35,0   | 40     | 240   | 153         | 2,0         |
| <b>595</b>                                | 8436017658545 | 18436017658542 | 3,0           | 32,0   | 32,5   | 4                   | 14,5           | 33,0   | 33,0   | 72     | 288   | 147         | 1,9         |
| <b>HBAS0501</b>                           | 8436584382171 | 18436584382178 | 32,0          | 32,0   | 3,5    | 6                   | 24,5           | 34,0   | 34,5   | 40     | 240   | 117         | 2,0         |
| <b>HBAS1155</b>                           | 8436584385196 | 18436584385193 | 0,0           | 0,0    | 0,0    | 6                   | 0,0            | 0,0    | 0,0    | 0      | 0     | 0           |             |
| <b>HBAS1501</b>                           | 8436584381785 | 18436584381782 | 3,5           | 37,5   | 37,5   | 6                   | 20,0           | 39,0   | 39,5   | 36     | 216   | 131         | 2,2         |
| <b>HBAS1524</b>                           | 8436584384823 | 18436584384820 | 3,0           | 29,0   | 29,0   | 6                   | 20,0           | 30,0   | 31,0   | 48     | 288   | 141         | 1,3         |
| <b>BATHROOM SCALES AND KITCHEN SCALES</b> |               |                |               |        |        |                     |                |        |        |        |       |             |             |
| <b>80</b>                                 | 8436017660104 | 18436017660101 | 6,0           | 10,2   | 23,8   | 9                   | 20,5           | 34,0   | 26,4   | 66     | 594   | 173         | 0,2         |
| <b>719</b>                                | 8436017659351 | 18436017659358 | 3,0           | 19,0   | 23,0   | 6                   | 21,0           | 22,0   | 26,0   | 72     | 432   | 174         | 0,4         |
| <b>720</b>                                | 8436017659580 | 18436017659587 | 3,0           | 19,0   | 23,0   | 6                   | 21,0           | 22,0   | 26,0   | 72     | 432   | 141         | 0,4         |
| <b>721</b>                                | 8436017659993 | 18436017659990 | 5,0           | 15,5   | 23,5   | 8                   | 21,5           | 33,0   | 25,5   | 45     | 360   | 143         | 0,5         |
| <b>722</b>                                | 8436017655865 | 18436017655862 | 1,5           | 19,0   | 19,0   | 8                   | 22,0           | 30,5   | 26,5   | 72     | 576   | 174         | 0,4         |
| <b>762</b>                                | 8436017659078 | 18436017659075 | 3,0           | 16,5   | 23,0   | 8                   | 17,5           | 25,5   | 25,0   | 84     | 672   | 165         | 0,5         |
| <b>773</b>                                | 8436017659061 | 18436017659068 | 3,5           | 13,5   | 17,5   | 8                   | 18,0           | 29,0   | 19,0   | 120    | 960   | 145         | 0,4         |
| <b>775</b>                                | 8436017659887 | 18436017659884 | 4,3           | 20,2   | 25,6   | 6                   | 27,5           | 27,5   | 22,5   | 72     | 432   | 177         | 0,9         |
| <b>780</b>                                | 8436017659658 | 18436017659655 | 22,9          | 3,5    | 31,7   | 6                   | 24,4           | 25,0   | 34,0   | 48     | 288   | 150         | 1,1         |
| <b>55K</b>                                | 8436017659597 | 18436017659594 | 5,0           | 7,5    | 18,1   | 12                  | 16,9           | 32,0   | 21,3   | 98     | 1176  | 164         | 0,1         |
| <b>56K</b>                                | 8436017660012 | 18436017660019 | 4,2           | 9,7    | 20,8   | 8                   | 20,0           | 21,7   | 23,8   | 90     | 720   | 160         | 0,1         |
| <b>722CS</b>                              | 8436584380245 | 18436584380242 | 2,0           | 19,5   | 23,0   | 8                   | 20,0           | 25,0   | 23,0   | 72     | 576   | 156         | 0,4         |
| <b>722CSITA</b>                           | 8436584380245 | 18436584380242 | 2,0           | 19,5   | 23,0   | 6                   | 13,5           | 24,0   | 21,5   | 108    | 648   | 144         | 0,4         |
| <b>722P</b>                               | 8436017656619 | 18436017656616 | 2,0           | 19,5   | 23,0   | 12                  | 14,0           | 41,0   | 21,5   | 105    | 1260  | 168         | 0,4         |
| <b>729R</b>                               | 8436017659092 | 18436017659099 | 2,0           | 18,5   | 21,0   | 6                   | 19,0           | 23,5   | 21,0   | 96     | 576   | 147         | 0,6         |
| <b>729V</b>                               | 8436017659108 | 18436017659105 | 3,0           | 19,0   | 21,0   | 6                   | 22,0           | 21,0   | 24,0   | 72     | 432   | 147         | 0,4         |
| <b>731K</b>                               | 8436584381044 | 18436584381041 | 2,5           | 15,0   | 21,0   | 6                   | 16,5           | 17,0   | 23,0   | 144    | 864   | 168         | 0,5         |
| <b>732K</b>                               | 8436584381037 | 18436584381034 | 2,5           | 15,0   | 21,0   | 6                   | 16,5           | 17,0   | 23,0   | 144    | 864   | 168         | 0,5         |
| <b>HBAL0370</b>                           | 8436584381761 | 18436584381768 | 3,0           | 13,0   | 23,5   | 8                   | 15,0           | 28,0   | 26,0   | 108    | 864   | 165         | 0,4         |
| <b>HBAL1110</b>                           | 8436584384687 | 18436584384684 | -             | -      | -      | 6                   | -              | -      | -      | -      | -     | -           | -           |
| <b>HBAL1202</b>                           | 8436584381839 | 18436584381836 | 5,0           | 15,5   | 20,0   | 8                   | 21,0           | 32,5   | 22,5   | 55     | 440   | 128         | 0,4         |
| <b>HBAL1203</b>                           | 8436584381754 | 18436584381751 | 2,5           | 18,0   | 20,5   | 12                  | 19,5           | 34,0   | 22,0   | 84     | 1008  | 169         | 0,3         |
| <b>HBAL1204</b>                           | 8436584382225 | 18436584382222 | 3,5           | 23,5   | 32,0   | 6                   | 21,5           | 25,0   | 34,5   | 72     | 432   | 144         | 1,0         |
| <b>HBAL1207</b>                           | 8436584382492 | 18436584382499 | 5,0           | 15,5   | 23,0   | 6                   | 16,5           | 30,5   | 23,0   | 112    | 672   | 176         | 0,5         |
| <b>HBAL1208</b>                           | 8436584382607 | 18436584382604 | 3,0           | 22,0   | 21,0   | 6                   | 20,0           | 25,0   | 24,0   | 84     | 504   | 159         | 0,4         |

| REFERENCE            | EAN13         | ITF14          | UNIT BOX (cm) |        |        | UNITS PER PACKAGING | PACKAGING (cm) |        |        | PALLET |       |             | WEIGHT (Kg) |
|----------------------|---------------|----------------|---------------|--------|--------|---------------------|----------------|--------|--------|--------|-------|-------------|-------------|
|                      |               |                | WIDTH         | LENGTH | HEIGHT |                     | WIDTH          | LENGTH | HEIGHT | BOXES  | UNITS | HEIGHT (cm) |             |
| <b>HBAL1220</b>      | 8436584381679 | 18436584381676 | 4,5           | 15,5   | 23,5   | 8                   | 21,5           | 32,5   | 25,5   | 84     | 672   | 168         | 0,5         |
| <b>HBAL1254</b>      | 8436584385011 | 18436584385018 | 4,0           | 19,0   | 24,0   | 6                   | 0,0            | 0,0    | 0,0    | 0      | 0     | 0           | 0,6         |
| <b>HBAL1300</b>      | 8436584384489 | 18436584384486 | 3,0           | 15,5   | 22,0   | 6                   | 18,5           | 20,5   | 24,5   | 112    | 672   | 159         | 0,3         |
| <b>HBAL1709</b>      | 8436584384496 | 18436584384493 | 6,0           | 18,0   | 19,5   | 6                   | 18,5           | 37,5   | 20,5   | 96     | 576   | 162         | 0,4         |
| <b>HBAL1774</b>      | 8436584383680 | 18436584383687 | 3,5           | 10,0   | 20,0   | 12                  | 19,5           | 21,5   | 22,0   | 112    | 1344  | 169         | 0,1         |
| <b>HBAL1775</b>      | 8436584383918 | 18436584383915 | 3,5           | 13,0   | 24,0   | 8                   | 17,0           | 43,0   | 14,7   | 100    | 800   | 180         | 0,3         |
| <b>HBAL7230</b>      | 8436584382249 | 18436584382246 | 2,5           | 19,5   | 22,0   | 8                   | 23,0           | 24,5   | 23,0   | 84     | 672   | 155         | 0,4         |
| <b>HBAL7240</b>      | 8436584382256 | 18436584382253 | 2,5           | 19,5   | 22,0   | 8                   | 23,0           | 24,5   | 23,0   | 84     | 672   | 155         | 0,4         |
| <b>HBL0300</b>       | 8436584381365 | 18436584381362 | 3,0           | 19,0   | 23,0   | 6                   | 21,0           | 22,0   | 26,0   | 72     | 432   | 141         | 0,4         |
| <b>HBL0310</b>       | 8436584381372 | 18436584381379 | 3,0           | 19,5   | 23,5   | 6                   | 22,0           | 22,5   | 26,0   | 72     | 432   | 172         | 0,5         |
| <b>610N</b>          | 8436017651928 | 18436017651925 | 7,5           | 20,0   | 20,0   | 6                   | 21,5           | 47,5   | 21,5   | 49     | 294   | 166         | 0,4         |
| <b>290N</b>          | 8436017659962 | 18436017659969 | 3,0           | 31,5   | 32,0   | 6                   | 23,5           | 34,0   | 34,0   | 40     | 240   | 151         | 1,7         |
| <b>290P</b>          | 8436017658149 | 18436017658146 | 3,5           | 31,5   | 32,0   | 6                   | 23,0           | 34,0   | 34,0   | 40     | 240   | 151         | 1,7         |
| <b>290R</b>          | 8436017658132 | 18436017658139 | 3,5           | 31,5   | 32,0   | 6                   | 23,0           | 34,0   | 34,0   | 40     | 240   | 151         | 1,7         |
| <b>290V</b>          | 8436017658125 | 18436017658122 | 3,5           | 31,5   | 31,5   | 6                   | 23,0           | 33,0   | 34,5   | 40     | 240   | 151         | 1,7         |
| <b>294K</b>          | 8436584381013 | 18436584381010 | 2,5           | 31,0   | 31,0   | 6                   | 17,0           | 32,5   | 32,5   | 56     | 336   | 145         | 1,5         |
| <b>295K</b>          | 8436584381020 | 18436584381027 | 2,5           | 31,0   | 31,0   | 6                   | 17,0           | 32,5   | 32,5   | 56     | 336   | 143         | 1,5         |
| <b>430</b>           | 8436017659603 | 18436017659600 | 4,7           | 33,0   | 35,5   | 6                   | 31,5           | 34,5   | 38,2   | 24     | 144   | 164         | 1,7         |
| <b>489</b>           | 8436584380146 | 18436584380143 | 3,0           | 31,0   | 31,0   | 6                   | 19,5           | 33,5   | 33,0   | 48     | 288   | 143         | 1,1         |
| <b>493N</b>          | 8436017658842 | 18436017658849 | 2,5           | 30,0   | 30,0   | 6                   | 30,0           | 36,5   | 42,0   | 32     | 192   | 173         | 1,7         |
| <b>496N</b>          | 8436017659610 | 18436017659617 | 3,0           | 31,0   | 31,0   | 6                   | 20,0           | 32,5   | 32,5   | 48     | 288   | 146         | 2,0         |
| <b>498</b>           | 8436017659627 | 18436017659624 | 3,0           | 31,0   | 30,0   | 6                   | 20,0           | 32,0   | 32,5   | 48     | 288   | 145         | 1,7         |
| <b>499</b>           | 8436017659047 | 18436017659044 | 5,0           | 27,5   | 33,5   | 4                   | 22,0           | 34,5   | 29,0   | 55     | 220   | 160         | 1,7         |
| <b>517</b>           | 8436584380122 | 18436584380129 | 3,0           | 29,0   | 29,0   | 6                   | 20,5           | 30,0   | 30,5   | 60     | 360   | 168         | 1,3         |
| <b>530</b>           | 8436017655162 | 8436017655179  | 7,6           | 33,4   | 33,8   | 4                   | 32,2           | 34,7   | 36,7   | 32     | 128   | 157         | 2,4         |
| <b>535</b>           | 8436584380610 | 18436584380617 | 4,0           | 30,5   | 25,5   | 4                   | 17,0           | 32,5   | 28,0   | 70     | 280   | 153         | 1,3         |
| <b>578</b>           | 8436017656831 | 18436017656838 | 3,0           | 31,5   | 32,4   | 6                   | 20,9           | 33,1   | 34,8   | 44     | 264   | 151         | 1,9         |
| <b>HBAS0500</b>      | 8436584381778 | 18436584381775 | 2,5           | 31,0   | 31,0   | 6                   | 17,0           | 33,0   | 32,5   | 56     | 336   | 141         | 1,4         |
| <b>HBAS1290</b>      | 8436584382553 | 18436584382550 | 3,0           | 32,0   | 32,5   | 6                   | 22,0           | 35,5   | 34,0   | 40     | 240   | 151         | 1,6         |
| <b>HBAS1291</b>      | 8436584384977 | 18436584384974 | 3,0           | 29,0   | 29,0   | 6                   | 21,5           | 31,0   | 31,0   | 60     | 360   | 175         | 1,3         |
| <b>HBAS1292</b>      | 8436584384984 | 18436584384981 | 3,0           | 29,0   | 29,0   | 6                   | 21,5           | 31,0   | 31,0   | 60     | 360   | 175         | 1,3         |
| <b>HBAS1415</b>      | 8436584382645 | 18436584382642 | 2,5           | 31,0   | 35,0   | 6                   | 17,0           | 35,5   | 32,0   | 56     | 336   | 143         | 1,5         |
| <b>HBAS1416</b>      | 8436584382652 | 18436584382659 | 3,0           | 32,0   | 32,0   | 4                   | 15,0           | 33,5   | 35,0   | 56     | 224   | 155         | 1,7         |
| <b>HBAS1417</b>      | 8436584383697 | 18436584383694 | 3,5           | 31,5   | 31,5   | 6                   | 23,0           | 33,5   | 33,5   | 44     | 264   | 149         | 2,0         |
| <b>HBAS1424</b>      | 8436584384694 | 18436584384691 | 31,5          | 31,5   | 3,0    | 6                   | 19,5           | 33,0   | 33,0   | 48     | 288   | 147         | 1,4         |
| <b>HBAS1490</b>      | 8436584381808 | 18436584381805 | 3,0           | 27,0   | 27,5   | 6                   | 23,0           | 28,5   | 29,5   | 60     | 360   | 158         | 1,0         |
| <b>HBAS1492</b>      | 8436584384700 | 18436584384707 | 25,0          | 30,0   | 27,0   | 6                   | 18,0           | 31,0   | 29,0   | 56     | 336   | 131         | 1,2         |
| <b>HBAS1499</b>      | 8436584382232 | 18436584382239 | 5,0           | 27,5   | 33,5   | 4                   | 22,0           | 34,5   | 29,0   | 55     | 220   | 160         | 1,7         |
| <b>HBAS1907</b>      | 8436584385042 | 18436584385049 | 0,0           | 0,0    | 0,0    | 6                   | 0,0            | 0,0    | 0,0    | 0      | 0     | 0           |             |
| <b>68</b>            | 8436017660050 | 18436017660057 | 7,0           | 32,5   | 31,5   | 8                   | 34,0           | 58,0   | 34,0   | 16     | 128   | 151         | 1,5         |
| <b>70</b>            | 8436584380627 | 18436584380624 | 29,0          | 31,5   | 6,0    | 6                   | 30,0           | 37,5   | 33,0   | 24     | 144   | 145         | 1,5         |
| <b>COOKWARE SETS</b> |               |                |               |        |        |                     |                |        |        |        |       |             |             |
| <b>BC3</b>           | 8436017659856 | 18436017659853 | 15,5          | 47,0   | 34,5   | 2                   | 37,0           | 50,0   | 33,0   | 16     | 32    | 147         | 4,5         |
| <b>BC4</b>           | 8436017659214 | 18436017659211 | 34,0          | 52,9   | 16,9   | 2                   | 35,5           | 54,3   | 35,1   | 16     | 32    | 154         | 5,6         |
| <b>BC8</b>           | 8436017659221 | 18436017659228 | 28,0          | 49,5   | 16,5   | 2                   | 28,5           | 51,0   | 34,5   | 24     | 48    | 155         | 5,6         |
| <b>BC10</b>          | 8436017659238 | 18436017659235 | 27,0          | 52,5   | 21,0   | 2                   | 29,0           | 54,0   | 44,0   | 18     | 36    | 177         | 7,6         |
| <b>HBAT3700</b>      | 8436584381631 | 18436584381638 | 33,5          | 50,0   | 17,0   | 2                   | 35,5           | 52,5   | 35,5   | 16     | 32    | 159         | 4,4         |

| REFERENCE                        | EAN13         | ITF14          | UNIT BOX (cm) |        |        | UNITS PER PACKAGING | PACKAGING (cm) |        |        | PALLET |       |             | WEIGHT (Kg) |
|----------------------------------|---------------|----------------|---------------|--------|--------|---------------------|----------------|--------|--------|--------|-------|-------------|-------------|
|                                  |               |                | WIDTH         | LENGTH | HEIGHT |                     | WIDTH          | LENGTH | HEIGHT | BOXES  | UNITS | HEIGHT (cm) |             |
| <b>COFFEE MAKERS</b>             |               |                |               |        |        |                     |                |        |        |        |       |             |             |
| <b>CAX104</b>                    | 8436017658163 | 18436017658160 | 11,5          | 13,5   | 18,0   | 6                   | 25,5           | 42,0   | 20,0   | 49     | 294   | 159         | 0,5         |
| <b>CAX106</b>                    | 8436017658170 | 18436017658177 | 12,0          | 14,5   | 20,5   | 6                   | 26,5           | 43,5   | 23,0   | 42     | 252   | 174         | 0,7         |
| <b>CAX110</b>                    | 8436017658187 | 18436017658184 | 14,0          | 14,0   | 23,0   | 6                   | 30,0           | 43,5   | 25,0   | 36     | 216   | 165         | 0,8         |
| <b>CAX112</b>                    | 8436017659436 | 18436017659433 | 14,0          | 15,5   | 27,5   | 6                   | 30,5           | 48,0   | 30,0   | 30     | 180   | 165         | 1,1         |
| <b>CCA12</b>                     | 8436017658613 | 18436017658610 | 14,5          | 17,5   | 26,0   | 6                   | 30,5           | 53,5   | 28,5   | 30     | 180   | 160         | 0,9         |
| <b>CCA3</b>                      | 8436017658583 | 18436017658580 | 9,5           | 15,0   | 16,0   | 12                  | 30,5           | 61,5   | 18,5   | 40     | 480   | 165         | 0,4         |
| <b>CCA6</b>                      | 8436017658590 | 18436017658597 | 11,5          | 16,5   | 20,5   | 12                  | 48,0           | 50,5   | 23,0   | 21     | 252   | 159         | 0,5         |
| <b>CCA9</b>                      | 8436017658606 | 18436017658603 | 12,5          | 17,0   | 23,0   | 12                  | 39,0           | 69,5   | 25,5   | 18     | 216   | 154         | 0,7         |
| <b>CCA9-6</b>                    | 8436017658606 | 18436584385315 | 0,0           | 0,0    | 0,0    |                     | 0,0            | 0,0    | 0,0    | 0      | 0     | 0           |             |
| <b>CFI12</b>                     | 8436017659849 | 18436017659846 | 14,5          | 18,5   | 24,5   | 6                   | 30,5           | 57,5   | 27,5   | 30     | 180   | 173         | 0,9         |
| <b>CFI6</b>                      | 8436017659825 | 18436017659822 | 12,0          | 14,5   | 20,5   | 6                   | 31,7           | 44,5   | 20,5   | 42     | 252   | 153         | 0,6         |
| <b>CFI9</b>                      | 8436017659832 | 18436017659839 | 13,8          | 16,2   | 22,5   | 6                   | 28,5           | 50,5   | 24,5   | 30     | 180   | 162         | 0,8         |
| <b>HCAF1135</b>                  | 8436584385233 | 18436584385230 | 0,0           | 0,0    | 0,0    | 6                   | 0,0            | 0,0    | 0,0    | 0      | 0     | 0           |             |
| <b>HCAF1160</b>                  | 8436584385240 | 18436584385247 | 0,0           | 0,0    | 0,0    | 6                   | 0,0            | 0,0    | 0,0    | 0      | 0     | 0           |             |
| <b>HCAF2006</b>                  | 8436584381907 | 18436584381904 | 11,0          | 14,2   | 21,0   | 6                   | 24,5           | 44,0   | 22,5   | 49     | 294   | 176         | 0,6         |
| <b>HCAF2009</b>                  | 8436584381914 | 18436584381911 | 13,0          | 15,0   | 23,5   | 6                   | 26,6           | 47,0   | 25,0   | 36     | 216   | 165         | 0,8         |
| <b>HCAF2012</b>                  | 8436584381921 | 18436584381928 | 13,5          | 16,5   | 26,5   | 6                   | 29,0           | 51,0   | 28,0   | 30     | 180   | 158         | 1,0         |
| <b>HCAF2403</b>                  | 8436584384991 | 18436584384998 | 0,0           | 0,0    | 0,0    | 6                   | 0,0            | 0,0    | 0,0    | 0      | 0     | 0           |             |
| <b>HCAF2406</b>                  | 8436584384731 | 18436584384738 | 0,0           | 0,0    | 0,0    | 6                   | 0,0            | 0,0    | 0,0    | 0      | 0     | 0           |             |
| <b>HCAF2409</b>                  | 8436584384748 | 18436584384745 | 0,0           | 0,0    | 0,0    | 6                   | 0,0            | 0,0    | 0,0    | 0      | 0     | 0           |             |
| <b>HCAF2412</b>                  | 8436584384755 | 18436584384752 | 0,0           | 0,0    | 0,0    | 6                   | 0,0            | 0,0    | 0,0    | 0      | 0     | 0           |             |
| <b>COFFEE MAKERS SPARE PARTS</b> |               |                |               |        |        |                     |                |        |        |        |       |             |             |
| <b>HCAF200609</b>                | 8436584384069 | 18436584384066 | 8,0           | 11,0   | 13,5   | 48                  | 36,0           | 40,5   | 23,5   | 40     | 1920  | 159         | 0,0         |
| <b>HCAF200910</b>                | 8436584384076 | 18436584384073 | 7,5           | 14,0   | 21,0   | 48                  | 36,0           | 40,5   | 23,5   | 40     | 1920  | 159         | 0,0         |
| <b>HCAF201217</b>                | 8436584384083 | 18436584384080 | 8,0           | 14,0   | 19,0   | 48                  | 36,0           | 40,5   | 23,5   | 40     | 1920  | 159         | 0,0         |
| <b>HCAF240308</b>                | 8436584385134 | 18436584385131 | 0,0           | 0,0    | 0,0    |                     | 0,0            | 0,0    | 0,0    | 0      | 0     | 0           |             |
| <b>HCAF241208</b>                | 8436584385141 | 18436584385148 | 0,0           | 0,0    | 0,0    |                     | 0,0            | 0,0    | 0,0    | 0      | 0     | 0           |             |
| <b>HRCA7006</b>                  | 8436584383468 | 18436584383465 | 0,5           | 11,0   | 13,0   | 48                  | 11,5           | 21,5   | 17,5   | 224    | 10752 | 176         | 0,0         |
| <b>HRCA7009</b>                  | 8436584383536 | 18436584383533 | 0,5           | 11,0   | 13,0   | 48                  | 11,5           | 21,5   | 17,5   | 224    | 10752 | 176         | 0,0         |
| <b>HRCA7012</b>                  | 8436584383581 | 18436584383588 | 0,5           | 11,0   | 13,0   | 48                  | 14,0           | 27,5   | 20,0   | 144    | 6912  | 176         | 0,0         |
| <b>HRCA7210</b>                  | 8436584383307 | 18436584383304 | 2,5           | 11,0   | 13,5   | 50                  | 17,5           | 29,0   | 19,5   | 0      | 0     | 0           | 0,1         |
| <b>HRCA7211</b>                  | 8436584383390 | 18436584383397 | 2,5           | 11,0   | 14,0   | 50                  | 18,0           | 29,0   | 20,0   | 0      | 0     | 0           | 0,1         |
| <b>HRCA7212</b>                  | 8436584383406 | 18436584383403 | 1,0           | 11,0   | 15,0   | 50                  | 19,0           | 18,0   | 16,5   | 0      | 0     | 0           | 0,0         |
| <b>HRCA7213</b>                  | 8436584383413 | 18436584383410 | 1,0           | 11,0   | 15,5   | 50                  | 19,0           | 18,5   | 16,5   | 0      | 0     | 0           | 0,0         |
| <b>HRCA7214</b>                  | 8436584383420 | 18436584383427 | 1,0           | 11,0   | 15,5   | 50                  | 19,0           | 18,5   | 16,5   | 0      | 0     | 0           | 0,0         |
| <b>HRCA7215</b>                  | 8436584383437 | 18436584383434 | 1,0           | 11,0   | 15,5   | 50                  | 18,5           | 19,0   | 16,0   | 0      | 0     | 0           | 0,0         |
| <b>HRCA7221</b>                  | 8436584383444 | 18436584383441 | 2,0           | 11,0   | 13,0   | 48                  | 28,5           | 30,0   | 19,5   | 60     | 2880  | 158         | 0,0         |
| <b>HRCA7222</b>                  | 8436584383451 | 18436584383458 | 2,0           | 11,0   | 12,5   | 48                  | 28,5           | 30,0   | 19,5   | 60     | 2880  | 158         | 0,1         |
| <b>HRCA7231</b>                  | 8436584383499 | 18436584383496 | 2,0           | 11,0   | 11,0   | 48                  | 28,5           | 30,0   | 19,5   | 60     | 2880  | 158         | 0,0         |
| <b>HRCA7232</b>                  | 8436584383505 | 18436584383502 | 2,0           | 11,0   | 12,0   | 48                  | 28,5           | 30,0   | 19,5   | 60     | 2880  | 158         | 0,1         |
| <b>HRCA7233</b>                  | 8436584383512 | 18436584383519 | 2,0           | 11,0   | 14,5   | 48                  | 28,5           | 30,0   | 19,5   | 60     | 2880  | 158         | 0,1         |
| <b>HRCA7234</b>                  | 8436584383529 | 18436584383526 | 0,5           | 11,0   | 13,0   | 48                  | 11,5           | 21,5   | 17,5   | 224    | 10752 | 176         | 0,0         |
| <b>HRCA7241</b>                  | 8436584383567 | 18436584383564 | 2,0           | 11,0   | 12,0   | 48                  | 28,5           | 30,0   | 19,5   | 60     | 2880  | 158         | 0,0         |
| <b>HRCA7242</b>                  | 8436584383574 | 18436584383571 |               |        |        |                     |                |        |        |        |       | 0           |             |
| <b>HRCA7243</b>                  | 8436584385158 | 18436584385155 | 0,0           | 0,0    | 0,0    |                     | 0,0            | 0,0    | 0,0    | 0      | 0     | 0           |             |
| <b>HRCA7244</b>                  | 8436584385165 | 18436584385162 | 0,0           | 0,0    | 0,0    |                     | 0,0            | 0,0    | 0,0    | 0      | 0     | 0           |             |
| <b>HRCA7245</b>                  | 8436584385172 | 18436584385179 | 0,0           | 0,0    | 0,0    |                     | 0,0            | 0,0    | 0,0    | 0      | 0     | 0           |             |

| REFERENCE               | EAN13         | ITF14          | UNIT BOX (cm) |        |        | UNITS PER PACKAGING | PACKAGING (cm) |        |        | PALLET |       |             | WEIGHT (Kg) |
|-------------------------|---------------|----------------|---------------|--------|--------|---------------------|----------------|--------|--------|--------|-------|-------------|-------------|
|                         |               |                | WIDTH         | LENGTH | HEIGHT |                     | WIDTH          | LENGTH | HEIGHT | BOXES  | UNITS | HEIGHT (cm) |             |
| <b>RCAX104013</b>       | 8436584384090 | 18436584384097 | 5,5           | 11,0   | 15,0   | 50                  | 19,5           | 35,5   | 23,5   | 0      | 0     | 0           | 0,0         |
| <b>RCAX106014</b>       | 8436584384106 | 18436584384103 | 6,5           | 11,0   | 14,0   | 50                  | 0,0            | 0,0    | 0,0    | 0      | 0     | 0           | 0,0         |
| <b>RCAX110015</b>       | 8436584384113 | 18436584384110 | 8,0           | 11,0   | 14,5   | 50                  | 30,0           | 44,0   | 18,0   | 0      | 0     | 0           | 0,1         |
| <b>RCAX112016</b>       | 8436584384120 | 18436584384127 | 8,0           | 11,0   | 14,0   | 50                  | 30,0           | 43,0   | 21,0   | 0      | 0     | 0           | 0,1         |
| <b>RCCA1221</b>         | 8436584384021 | 18436584384028 | 8,5           | 14,0   | 18,0   | 48                  | 36,0           | 40,5   | 23,5   | 40     | 1920  | 159         | 0,0         |
| <b>RCCA3018</b>         | 8436584383994 | 18436584383991 | 6,0           | 11,0   | 11,5   | 48                  | 28,5           | 30,0   | 19,5   | 60     | 2880  | 158         | 0,0         |
| <b>RCCA6019</b>         | 8436584384007 | 18436584384004 | 6,5           | 11,0   | 12,5   | 48                  | 36,0           | 40,5   | 23,5   | 40     | 1920  | 159         | 0,0         |
| <b>RCCA9020</b>         | 8436584384014 | 18436584384011 | 7,5           | 14,0   | 21,0   | 48                  | 36,0           | 40,5   | 23,5   | 40     | 1920  | 159         | 0,0         |
| <b>RCFI1210</b>         | 8436584384052 | 18436584384059 | 8,5           | 14,0   | 18,5   | 48                  | 36,0           | 40,5   | 23,5   | 40     | 1920  | 159         | 0,0         |
| <b>RCFI6008</b>         | 8436584384038 | 18436584384035 | 7,0           | 11,0   | 13,0   | 48                  | 28,5           | 30,0   | 19,5   | 60     | 2880  | 158         | 0,0         |
| <b>RCFI9009</b>         | 8436584384045 | 18436584384042 | 7,0           | 14,0   | 19,5   | 48                  | 36,0           | 40,5   | 23,5   | 40     | 1920  | 159         | 0,0         |
| <b>GRILLS</b>           |               |                |               |        |        |                     |                |        |        |        |       |             |             |
| <b>G24</b>              | 8436017659467 | 18436017659464 | 4,5           | 18,5   | 28,0   | 6                   | 48,0           | 29,5   | 29,8   | 30     | 180   | 164         | 1,3         |
| <b>G28</b>              | 8436017659474 | 18436017659471 | 33,6          | 23,0   | 0,2    | 6                   | 33,6           | 51,1   | 30,0   | 20     | 120   | 148         | 1,6         |
| <b>GMA28</b>            | 8436017658910 | 18436017658917 | 32,6          | 22,7   | 0,2    | 6                   | 31,4           | 31,2   | 28,2   | 30     | 180   | 155         | 1,1         |
| <b>GP35</b>             | 8436017658927 | 18436017658924 | 30,0          | 27,8   | 0,2    | 6                   | 32,5           | 37,2   | 29,0   | 30     | 180   | 169         | 1,1         |
| <b>GR25</b>             | 8436017659672 | 18436017659679 | 5,5           | 36,3   | 27,7   | 4                   | 25,1           | 38,0   | 29,8   | 36     | 144   | 134         | 2,4         |
| <b>GR33</b>             | 8436017659689 | 18436017659686 | 5,0           | 43,9   | 23,8   | 4                   | 22,4           | 45,2   | 25,6   | 35     | 140   | 143         | 2,8         |
| <b>GR53</b>             | 8436584380665 | 18436584380662 | 23,5          | 43,5   | 5,0    | 4                   | 21,4           | 45,3   | 26,0   | 35     | 140   | 140         | 3,0         |
| <b>WATER JARS</b>       |               |                |               |        |        |                     |                |        |        |        |       |             |             |
| <b>HJAR1001</b>         | 8436584382461 | 18436584382468 | 12,0          | 24,5   | 31,0   | 6                   | 36,0           | 63,0   | 26,5   | 24     | 144   | 175         | 1,5         |
| <b>HJAR1003</b>         | 8436584382478 | 18436584382475 | 13,5          | 26,5   | 28,5   | 6                   | 41,0           | 54,5   | 31,0   | 18     | 108   | 179         | 1,6         |
| <b>JH01</b>             | 8436017654080 | 18436017659280 | 10,5          | 25,0   | 29,0   | 6                   | 33,5           | 51,0   | 32,0   | 20     | 120   | 175         | 0,9         |
| <b>WATER FILTERS</b>    |               |                |               |        |        |                     |                |        |        |        |       |             |             |
| <b>RE123X4</b>          | 8436017654523 | 18436017654520 | 12,5          | 23,0   | 9,0    | 6                   | 39,5           | 47,0   | 11,5   | 56     | 336   | 173         | 0,6         |
| <b>SILICONE MOULDS</b>  |               |                |               |        |        |                     |                |        |        |        |       |             |             |
| <b>HMOL1124</b>         | 8436584385288 | 18436584385285 | 0,0           | 0,0    | 0,0    | 4                   | 0,0            | 0,0    | 0,0    | 0      | 0     | 0           |             |
| <b>HMOL1324</b>         | 8436584385301 | 18436584385308 | 0,0           | 0,0    | 0,0    | 4                   | 0,0            | 0,0    | 0,0    | 0      | 0     | 0           |             |
| <b>HMOL2065</b>         | 8436584384229 | 18436584384226 | 5,0           | 18,0   | 31,5   | 6                   | 33,0           | 37,5   | 18,0   | 48     | 288   | 159         | 0,2         |
| <b>HMOL5211</b>         | 8436584382973 | 18436584382970 | 4,0           | 18,0   | 35,5   | 6                   | 19,5           | 32,0   | 20,5   | 104    | 624   | 179         | 0,2         |
| <b>HMOL5212</b>         | 8436584382980 | 18436584382987 | 3,0           | 26,5   | 40,5   | 6                   | 29,0           | 36,5   | 18,5   | 64     | 384   | 163         | 0,3         |
| <b>HMOL5213</b>         | 8436584382997 | 18436584382994 | 3,0           | 23,5   | 36,5   | 6                   | 26,0           | 32,5   | 19,0   | 81     | 486   | 186         | 0,2         |
| <b>HMOL5214</b>         | 8436584383000 | 18436584383007 | 24,0          | 27,0   | 10,5   | 6                   | 25,5           | 29,5   | 32,0   | 50     | 300   | 175         | 0,3         |
| <b>HMOL5215</b>         | 8436584383017 | 18436584383014 | 7,0           | 28,0   | 29,0   | 6                   | 29,0           | 30,5   | 29,0   | 40     | 240   | 160         | 0,3         |
| <b>HMOL5216</b>         | 8436584383024 | 18436584383021 | 3,5           | 33,5   | 34,5   | 6                   | 31,0           | 36,0   | 15,5   | 80     | 480   | 170         | 0,3         |
| <b>HMOL5218</b>         | 8436584383048 | 18436584383045 | 5,5           | 19,5   | 33,5   | 6                   | 22,0           | 35,0   | 12,5   | 132    | 792   | 165         | 0,2         |
| <b>HMOL5219</b>         | 8436584383055 | 18436584383052 | 8,0           | 13,0   | 34,5   | 6                   | 26,0           | 35,5   | 14,5   | 99     | 594   | 175         | 0,2         |
| <b>MC60</b>             | 8436017659153 | 18436017659150 | 34,4          | 26,6   | 0,2    | 6                   | 31,2           | 36,9   | 15,1   | 75     | 450   | 168         | 0,3         |
| <b>MC61</b>             | 8436017659160 | 18436017659167 | 33,4          | 14,5   | 0,2    | 6                   | 25,5           | 29,0   | 31,9   | 50     | 300   | 170         | 0,3         |
| <b>MC62</b>             | 8436017659177 | 18436017659174 | 21,0          | 29,0   | 3,5    | 6                   | 21,5           | 31,0   | 23,0   | 72     | 432   | 153         | 0,2         |
| <b>MC64</b>             | 8436017659191 | 18436017659198 | 27,5          | 15,7   | 0,2    | 6                   | 26,5           | 27,1   | 21,3   | 60     | 360   | 141         | 0,3         |
| <b>MC67</b>             | 8436017659535 | 18436017659532 | 9,0           | 10,0   | 11,5   | 6                   | 28,0           | 32,0   | 11,5   | 110    | 660   | 155         | 0,2         |
| <b>MC68</b>             | 8436017659542 | 18436017659549 | 6,2           | 23,8   | 23,4   | 6                   | 25,3           | 37,5   | 18,3   | 81     | 486   | 180         | 0,3         |
| <b>PRESSURE COOKERS</b> |               |                |               |        |        |                     |                |        |        |        |       |             |             |
| <b>HOLL2204</b>         | 8436584381709 | 18436584381706 | 29,0          | 30,0   | 17,0   | 4                   | 31,5           | 59,0   | 36,0   | 20     | 80    | 173         | 3,1         |
| <b>HOLL2206</b>         | 8436584381716 | 18436584381713 | 29,0          | 30,0   | 22,0   | 4                   | 31,5           | 59,5   | 46,0   | 10     | 40    | 134         | 3,3         |
| <b>HOLL2208</b>         | 8436584381723 | 18436584381720 | 30,5          | 31,0   | 24,5   | 2                   | 33,0           | 62,5   | 27,0   | 20     | 40    | 150         | 3,8         |
| <b>HOLL2210</b>         | 8436584381730 | 18436584381737 | 30,5          | 31,5   | 28,0   | 2                   | 33,0           | 61,5   | 30,0   | 20     | 40    | 165         | 4,0         |

| REFERENCE                          | EAN13         | ITF14          | UNIT BOX (cm) |        |        | UNITS PER PACKAGING | PACKAGING (cm) |        |        | PALLET |       |             | WEIGHT (Kg) |
|------------------------------------|---------------|----------------|---------------|--------|--------|---------------------|----------------|--------|--------|--------|-------|-------------|-------------|
|                                    |               |                | WIDTH         | LENGTH | HEIGHT |                     | WIDTH          | LENGTH | HEIGHT | BOXES  | UNITS | HEIGHT (cm) |             |
| <b>HOLL2226</b>                    | 8436584381860 | 18436584381867 | 28,5          | 42,5   | 21,5   | 2                   | 44,0           | 58,0   | 22,5   | 14     | 28    | 130         | 3,5         |
| <b>HOLL2228</b>                    | 8436584381877 | 18436584381874 | 29,0          | 43,0   | 25,5   | 2                   | 45,0           | 59,0   | 27,5   | 12     | 24    | 133         | 3,8         |
| <b>HOLL2230</b>                    | 8436584381884 | 18436584381881 | 28,5          | 43,0   | 30,0   | 2                   | 45,0           | 59,0   | 32,5   | 12     | 24    | 133         | 4,1         |
| <b>OPC4</b>                        | 8436017657685 | 18436017657682 | 22,5          | 33,0   | 21,0   | 4                   | 34,5           | 47,0   | 43,0   | 15     | 60    | 147         | 3,0         |
| <b>OPC6</b>                        | 8436017657692 | 18436017657699 | 25,5          | 33,0   | 23,0   | 4                   | 35,5           | 51,0   | 47,0   | 15     | 60    | 167         | 3,5         |
| <b>OPC8</b>                        | 8436017657715 | 18436017657712 | 27,0          | 35,0   | 25,0   | 2                   | 36,5           | 54,5   | 27,5   | 20     | 40    | 155         | 4,1         |
| <b>OPC10</b>                       | 8436017657722 | 18436017657729 | 28,0          | 35,0   | 26,5   | 2                   | 37,0           | 59,0   | 28,5   | 20     | 40    | 158         | 4,5         |
| <b>OSR4</b>                        | 8436017658255 | 18436017658252 | 30,0          | 30,0   | 22,5   | 1                   | 32,0           | 32,0   | 25,5   | 50     | 50    | 174         | 3,5         |
| <b>OSR6</b>                        | 8436017658262 | 18436017658269 | 30,0          | 30,5   | 27,0   | 1                   | 32,5           | 32,0   | 29,5   | 40     | 40    | 178         | 3,8         |
| <b>OSR8</b>                        | 8436017658279 | 18436017658276 | 30,5          | 30,0   | 31,5   | 1                   | 32,0           | 32,0   | 33,0   | 32     | 32    | 151         | 4,1         |
| <b>PRESSURE COOKER SPARE PARTS</b> |               |                |               |        |        |                     |                |        |        |        |       |             |             |
| <b>RACOPC</b>                      | 8436017659030 | 8436017659030  | 0,0           | 0,0    | 0,0    |                     | 0,0            | 0,0    | 0,0    | 0      | 0     | 0           | 0,0         |
| <b>RACOSR</b>                      | 8436017658941 | 8436017658941  | 0,0           | 0,0    | 0,0    |                     | 0,0            | 0,0    | 0,0    | 0      | 0     | 0           | 0,0         |
| <b>RATOSR</b>                      | 8436017658958 | 8436017658958  | 0,0           | 0,0    | 0,0    |                     | 0,0            | 0,0    | 0,0    | 0      | 0     | 0           | 0,0         |
| <b>RJC10</b>                       | 8436017657838 | 8436017657838  | 0,0           | 0,0    | 0,0    |                     | 0,0            | 0,0    | 0,0    | 0      | 0     | 0           | 0,0         |
| <b>RJC4</b>                        | 8436017657807 | 8436017657807  | 0,0           | 0,0    | 0,0    |                     | 0,0            | 0,0    | 0,0    | 0      | 0     | 0           | 0,0         |
| <b>RJC6</b>                        | 8436017657814 | 8436017657814  | 0,0           | 0,0    | 0,0    |                     | 0,0            | 0,0    | 0,0    | 0      | 0     | 0           | 0,0         |
| <b>RJC8</b>                        | 8436017657821 | 8436017657821  | 0,0           | 0,0    | 0,0    |                     | 0,0            | 0,0    | 0,0    | 0      | 0     | 0           | 0,0         |
| <b>RJSOSR</b>                      | 8436017658965 | 8436017658965  | 37,5          | 25,0   | 1,0    | 100                 | 0,0            | 0,0    | 0,0    | 0      | 0     | 0           | 0,1         |
| <b>RPTOPC</b>                      | 8436017659009 | 8436017659009  | 0,0           | 0,0    | 0,0    |                     | 0,0            | 0,0    | 0,0    | 0      | 0     | 0           | 0,0         |
| <b>RPTOPCN</b>                     |               |                | 0,0           | 0,0    | 0,0    |                     | 0,0            | 0,0    | 0,0    | 0      | 0     | 0           |             |
| <b>RVCOSR</b>                      | 8436017658972 | 8436017658972  | 0,0           | 0,0    | 0,0    |                     | 0,0            | 0,0    | 0,0    | 0      | 0     | 0           | 0,0         |
| <b>RVEOSR</b>                      | 8436017658996 | 8436017658996  | 0,0           | 0,0    | 0,0    |                     | 0,0            | 0,0    | 0,0    | 0      | 0     | 0           | 0,0         |
| <b>RVPOPC</b>                      | 8436017659016 | 8436017659016  | 0,0           | 0,0    | 0,0    |                     | 0,0            | 0,0    | 0,0    | 0      | 0     | 0           | 0,0         |
| <b>RVPOSR</b>                      | 8436017658989 | 8436017658989  | 0,0           | 0,0    | 0,0    |                     | 0,0            | 0,0    | 0,0    | 0      | 0     | 0           | 0,0         |
| <b>RVSOPC</b>                      | 8436017659023 | 8436017659023  | 0,0           | 0,0    | 0,0    |                     | 0,0            | 0,0    | 0,0    | 0      | 0     | 0           | 0,0         |
| <b>PAELLA PANS</b>                 |               |                |               |        |        |                     |                |        |        |        |       |             |             |
| <b>P34</b>                         | 8436017659801 | 18436017659808 | 25,0          | 35,0   | 5,0    | 4                   | 39,0           | 39,0   | 10,5   | 84     | 336   | 162         | 1,2         |
| <b>P38</b>                         | 8436017659818 | 18436017659815 | 29,0          | 39,0   | 5,0    | 4                   | 40,7           | 40,7   | 10,7   | 72     | 288   | 143         | 1,3         |
| <b>HPAE2132</b>                    | 8436584382737 | 18436584382734 | 6,0           | 33,0   | 39,0   | 4                   | 35,0           | 34,5   | 24,0   | 36     | 144   | 153         | 1,4         |
| <b>HPAE2138</b>                    | 8436584382744 | 18436584382741 | 5,5           | 39,0   | 46,5   | 4                   | 40,5           | 40,0   | 24,0   | 36     | 144   | 175         | 2,0         |
| <b>THERMIC LUNCH BAGS</b>          |               |                |               |        |        |                     |                |        |        |        |       |             |             |
| <b>923</b>                         | 8436017659382 | 18436017659389 | 13,8          | 13,8   | 37,0   | 6                   | 21,5           | 32,5   | 38,4   | 44     | 264   | 163         | 0,7         |
| <b>926</b>                         | 8436017659399 | 18436017659396 | 14,0          | 22,0   | 17,5   | 6                   | 30,4           | 35,5   | 18,4   | 60     | 360   | 163         | 0,5         |
| <b>952</b>                         | 8436017658804 | 18436017658801 | 17,0          | 24,0   | 13,6   | 6                   | 28,5           | 49,8   | 19,2   | 48     | 288   | 165         | 0,3         |
| <b>954</b>                         | 8436017658774 | 18436017658771 | 16,0          | 23,5   | 20,0   | 6                   | 50,5           | 49,5   | 23,5   | 21     | 126   | 167         | 0,6         |
| <b>970</b>                         | 8436017658750 | 18436017658757 | 24,0          | 43,5   | 6,0    | 6                   | 25,5           | 46,0   | 34,0   | 24     | 144   | 151         | 0,5         |
| <b>980</b>                         | 8436017659375 | 18436017659372 | 31,0          | 49,5   | 10,0   | 6                   | 31,0           | 54,0   | 37,5   | 20     | 120   | 170         | 0,6         |
| <b>985</b>                         | 8436017659870 | 18436017659877 | 6,0           | 38,0   | 41,0   | 6                   | 40,0           | 42,0   | 24,0   | 36     | 216   | 173         | 0,5         |
| <b>992</b>                         | 8436017659641 | 18436017659648 | 7,0           | 35,0   | 19,0   | 6                   | 37,4           | 51,2   | 22,0   | 28     | 168   | 162         | 1,1         |
| <b>994</b>                         | 8436017659634 | 18436017659631 | 10,0          | 32,0   | 20,0   | 6                   | 34,2           | 57,6   | 21,8   | 28     | 168   | 151         | 1,3         |
| <b>910N</b>                        | 8436017658828 | 18436017658825 | 14,0          | 22,5   | 23,0   | 6                   | 43,5           | 46,0   | 26,1   | 18     | 108   | 145         | 0,6         |
| <b>HPOR7000</b>                    | 8436584381938 | 18436584381935 | 3,0           | 32,0   | 36,0   | 12                  | 30,5           | 33,0   | 40,0   | 24     | 288   | 147         | 0,2         |
| <b>HPOR7010</b>                    | 8436584381945 | 18436584381942 | 4,5           | 22,5   | 37,0   | 6                   | 24,0           | 39,5   | 15,5   | 90     | 540   | 170         | 0,2         |
| <b>HPOR7020</b>                    | 8436584381976 | 18436584381973 | 5,5           | 22,0   | 38,0   | 6                   | 25,5           | 31,0   | 28,0   | 45     | 270   | 159         | 0,2         |
| <b>HPOR7025</b>                    | 8436584381952 | 18436584381959 | 4,0           | 24,5   | 36,5   | 6                   | 25,5           | 56,0   | 24,5   | 36     | 216   | 165         | 0,7         |
| <b>HPOR7030</b>                    | 8436584381969 | 18436584381966 | 5,0           | 55,0   | 42,5   | 6                   | 43,5           | 55,0   | 20,5   | 21     | 126   | 166         | 0,7         |
| <b>HPOR7035</b>                    | 8436584381983 | 18436584381980 | 3,5           | 32,0   | 41,0   | 6                   | 32,5           | 48,0   | 21,0   | 35     | 210   | 155         | 0,5         |



| REFERENCE                      | EAN13         | ITF14          | UNIT BOX (cm) |        |        | UNITS PER PACKAGING | PACKAGING (cm) |        |        | PALLET |       |             | WEIGHT (Kg) |
|--------------------------------|---------------|----------------|---------------|--------|--------|---------------------|----------------|--------|--------|--------|-------|-------------|-------------|
|                                |               |                | WIDTH         | LENGTH | HEIGHT |                     | WIDTH          | LENGTH | HEIGHT | BOXES  | UNITS | HEIGHT (cm) |             |
| HPOR7040                       | 8436584381990 | 18436584381997 | 61,0          | 45,0   | 4,5    | 6                   | 50,0           | 60,0   | 17,5   | 24     | 144   | 165         | 0,6         |
| HPOR7045                       | 8436584382003 | 18436584382000 | 60,0          | 47,5   | 4,0    | 6                   | 50,5           | 59,5   | 18,0   | 24     | 144   | 167         | 0,6         |
| HPOR7051                       | 8436584383185 | 18436584383182 | 25,0          | 28,0   | 41,5   | 6                   | 26,0           | 28,5   | 28,0   | 50     | 300   | 155         | 0,3         |
| HPOR7052                       | 8436584383192 | 18436584383199 | 28,0          | 10,0   | 52,0   | 6                   | 37,5           | 46,0   | 31,5   | 20     | 120   | 165         | 0,5         |
| HPOR7054                       | 8436584383215 | 18436584383212 | 7,0           | 24,5   | 47,0   | 6                   | 26,0           | 35,5   | 30,0   | 45     | 270   | 165         | 0,3         |
| HPOR7055                       | 8436584383284 | 18436584383281 | 14,5          | 23,0   | 30,0   | 6                   | 46,0           | 48,0   | 20,5   | 21     | 126   | 153         | 0,6         |
| HPOR7056                       | 8436584383178 | 18436584383175 | 18,0          | 48,0   | 75,0   | 6                   | 43,0           | 50,0   | 18,0   | 24     | 144   | 159         | 0,6         |
| HPOR7202                       | 8436584384250 | 18436584384257 | 4,5           | 7,0    | 21,0   | 6                   | 20,0           | 27,0   | 26,0   | 0      | 0     | 0           | 0,1         |
| HPOR7203                       | 8436584384267 | 18436584384264 | 2,5           | 7,0    | 16,0   | 6                   | 19,0           | 27,0   | 23,0   | 0      | 0     | 0           | 0,1         |
| <b>GLASS CONTAINERS</b>        |               |                |               |        |        |                     |                |        |        |        |       |             |             |
| HREC4200                       | 8436584381532 | 18436584381539 | 14,5          | 10,5   | 7,5    | 6                   | 15,5           | 33,0   | 16,0   | 144    | 864   | 159         | 0,3         |
| HREC4201                       | 8436584381549 | 18436584381546 | 12,5          | 17,0   | 8,0    | 6                   | 19,0           | 40,0   | 18,0   | 96     | 576   | 155         | 0,6         |
| HREC4202                       | 8436584381556 | 18436584381553 | 20,0          | 14,5   | 9,5    | 6                   | 22,0           | 46,0   | 20,0   | 49     | 294   | 155         | 0,8         |
| HREC4203                       | 8436584381563 | 18436584381560 | 18,0          | 23,5   | 12,0   | 4                   | 25,0           | 37,5   | 25,0   | 54     | 216   | 165         | 1,4         |
| HREC4204                       | 8436584381570 | 18436584381577 | 14,5          | 20,0   | 14,5   | 4                   | 22,0           | 31,0   | 30,5   | 60     | 240   | 168         | 1,9         |
| HREC4205                       | 8436584381587 | 18436584381584 | 18,5          | 24,0   | 12,5   | 4                   | 25,0           | 38,5   | 27,0   | 45     | 180   | 150         | 2,2         |
| HREC4230                       | 8436584383956 | 18436584383953 | 10,0          | 19,5   | 19,5   | 4                   | 22,5           | 40,0   | 22,5   | 60     | 240   | 141         | 1,7         |
| <b>FRY PANS AND SAUCE PANS</b> |               |                |               |        |        |                     |                |        |        |        |       |             |             |
| CF916                          | 8436584381167 | 18436584381164 | 10,0          | 14,5   | 17,5   | 6                   | 26,0           | 40,0   | 30,5   | 45     | 270   | 168         | 0,9         |
| CF920                          | 8436584381174 | 18436584381171 | 11,5          | 34,0   | 22,0   | 3                   | 23,5           | 36,5   | 37,5   | 36     | 108   | 165         | 1,4         |
| CF922                          | 8436584381181 | 18436584381188 | 12,0          | 35,5   | 24,0   | 3                   | 26,5           | 38,5   | 38,5   | 36     | 108   | 169         | 1,7         |
| CF924                          | 8436584381198 | 18436584381195 | 13,5          | 38,5   | 25,5   | 3                   | 27,5           | 40,0   | 44,0   | 24     | 72    | 147         | 2,0         |
| EXP02                          | 8436017660821 | 18436017660828 | 30,0          | 62,0   | 10,5   | 1                   | 30,0           | 62,0   | 10,5   | 48     | 48    | 135         | 4,3         |
| EXP03                          | 8436017656169 | 8436017656169  | 56,0          | 57,5   | 9,5    | 1                   | 56,0           | 57,5   | 9,5    | 45     | 45    | 180         | 5,0         |
| HCON5420                       | 8436584384885 | 18436584384882 | 5,0           | 21,0   | 36,5   | 6                   | 31,0           | 43,5   | 13,5   | 66     | 396   | 164         | 0,4         |
| HCON5424                       | 8436584384892 | 18436584384899 | 6,0           | 25,0   | 44,0   | 6                   | 33,5           | 51,5   | 14,5   | 55     | 330   | 175         | 0,6         |
| HCON5426                       | 8436584384908 | 18436584384905 | 7,0           | 27,0   | 46,0   | 6                   | 35,5           | 55,0   | 15,5   | 40     | 240   | 170         | 0,7         |
| HSAR2118                       | 8436584382805 | 18436584382802 | 5,5           | 19,5   | 36,0   | 6                   | 21,5           | 36,5   | 30,0   | 60     | 360   | 163         | 0,4         |
| HSAR2120                       | 8436584382812 | 18436584382819 | 5,5           | 21,0   | 38,0   | 6                   | 23,5           | 38,5   | 29,5   | 45     | 270   | 169         | 0,5         |
| HSAR2122                       | 8436584382829 | 18436584382826 | 7,0           | 23,0   | 43,0   | 6                   | 25,0           | 43,5   | 32,5   | 30     | 180   | 180         | 0,7         |
| HSAR2124                       | 8436584382836 | 18436584382833 | 6,0           | 25,0   | 46,0   | 6                   | 27,0           | 46,0   | 32,0   | 30     | 180   | 175         | 0,8         |
| HSAR2126                       | 8436584382843 | 18436584382840 | 8,0           | 27,5   | 47,5   | 4                   | 29,0           | 48,0   | 26,0   | 36     | 144   | 168         | 0,9         |
| HSAR2128                       | 8436584382850 | 18436584382857 | 7,5           | 29,5   | 49,5   | 4                   | 31,0           | 49,5   | 25,5   | 30     | 120   | 170         | 1,1         |
| HSAR2130                       | 8436584382867 | 18436584382864 | 8,0           | 31,5   | 52,0   | 4                   | 33,5           | 50,0   | 25,5   | 30     | 120   | 167         | 1,1         |
| HSAR2402                       | 8436584384953 | 18436584384950 | 9,0           | 25,0   | 46,0   | 6                   | 32,0           | 61,0   | 31,0   | 20     | 120   | 170         | 1,2         |
| HSAR2403                       | 8436584384960 | 18436584384967 | 12,5          | 27,0   | 46,0   | 4                   | 34,0           | 63,0   | 29,0   | 20     | 80    | 160         | 1,9         |
| SET S1 182226                  | 8436017658729 | 18436017658726 | 26,4          | 44,7   | 16,5   | 4                   | 32,4           | 59,2   | 23,2   | 35     | 140   | 174         | 1,7         |
| SET S1 2024                    | 8436584380672 | 18436584380679 | 38,1          | 24,3   | 9,1    | 6                   | 31,0           | 51,0   | 32,0   | 30     | 180   | 168         | 1,1         |
| SET S2026                      | 8436584380993 | 18436584380990 | 26,5          | 45,5   | 8,5    | 6                   | 32,0           | 55,5   | 21,0   | 30     | 180   | 120         | 1,3         |
| SET S2428                      | 8436584381006 | 18436584381003 | 28,7          | 48,0   | 12,5   | 3                   | 31,8           | 56,1   | 17,2   | 30     | 90    | 104         | 1,7         |
| SET SF1 182226                 | 8436584380641 | 18436584380648 | 15,0          | 27,0   | 46,5   | 4                   | 33,5           | 62,0   | 29,5   | 20     | 80    | 163         | 2,2         |
| SET SF1 2024                   | 8436017658712 | 18436017658719 | 12,0          | 25,0   | 43,0   | 4                   | 33,5           | 59,0   | 23,5   | 35     | 140   | 180         | 1,5         |
| SET SF3 182226                 | 8436017659986 | 18436017659983 | 13,0          | 26,5   | 46,0   | 4                   | 32,5           | 61,5   | 29,0   | 20     | 80    | 160         | 2,5         |
| SET SF3 2024                   | 8436017659979 | 18436017659976 | 10,5          | 24,0   | 44,5   | 6                   | 34,3           | 58,5   | 33,4   | 20     | 120   | 182         | 1,5         |
| SET SF4 182226                 | 8436017659788 | 18436017659785 | 26,5          | 35,5   | 13,0   | 4                   | 31,7           | 56,0   | 21,2   | 30     | 120   | 142         | 2,0         |
| SET SF4 2024                   | 8436017659795 | 18436017659792 | 25,0          | 28,0   | 9,5    | 4                   | 31,2           | 55,7   | 17,8   | 30     | 120   | 171         | 1,3         |
| SEW20M                         | 8436017656633 | 18436017656630 | 10,0          | 21,0   | 36,5   | 6                   | 27,5           | 43,5   | 17,0   | 54     | 324   | 168         | 0,6         |
| SEW24M                         | 8436017656657 | 18436017656654 | 11,5          | 25,0   | 43,0   | 6                   | 32,0           | 51,0   | 17,5   | 48     | 288   | 163         | 0,8         |

| REFERENCE             | EAN13         | ITF14          | UNIT BOX (cm) |        |        | UNITS PER PACKAGING | PACKAGING (cm) |        |        | PALLET |       |             | WEIGHT (Kg) |
|-----------------------|---------------|----------------|---------------|--------|--------|---------------------|----------------|--------|--------|--------|-------|-------------|-------------|
|                       |               |                | WIDTH         | LENGTH | HEIGHT |                     | WIDTH          | LENGTH | HEIGHT | BOXES  | UNITS | HEIGHT (cm) |             |
| <b>SEW28M</b>         | 8436017656671 | 18436017656678 | 11,0          | 29,0   | 47,0   | 6                   | 36,5           | 59,0   | 18,0   | 36     | 216   | 161         | 1,0         |
| <b>SF118</b>          | 8436017658439 | 18436017658436 | 8,5           | 19,0   | 34,5   | 6                   | 26,5           | 39,0   | 13,5   | 88     | 528   | 164         | 0,5         |
| <b>SF120</b>          | 8436017658446 | 18436017658443 | 8,5           | 21,0   | 36,5   | 6                   | 27,5           | 43,0   | 14,0   | 66     | 396   | 169         | 0,6         |
| <b>SF122</b>          | 8436017658453 | 18436017658450 | 9,0           | 23,0   | 38,5   | 6                   | 30,0           | 47,0   | 15,0   | 66     | 396   | 180         | 0,7         |
| <b>SF124</b>          | 8436017658460 | 18436017658467 | 9,0           | 25,0   | 43,0   | 6                   | 31,5           | 51,0   | 15,0   | 60     | 360   | 175         | 0,8         |
| <b>SF126</b>          | 8436017658477 | 18436017658474 | 9,5           | 27,0   | 45,0   | 6                   | 34,0           | 55,0   | 16,0   | 40     | 240   | 175         | 0,9         |
| <b>SF128</b>          | 8436017658484 | 18436017658481 | 9,0           | 29,0   | 47,0   | 6                   | 35,5           | 59,0   | 16,0   | 40     | 240   | 195         | 1,1         |
| <b>SF130</b>          | 8436017658491 | 18436017658498 | 10,0          | 31,0   | 49,0   | 6                   | 38,0           | 63,0   | 17,0   | 40     | 240   | 185         | 1,2         |
| <b>SF318</b>          | 8436017658620 | 18436017658627 | 19,0          | 35,5   | 8,0    | 6                   | 28,0           | 41,0   | 14,5   | 90     | 540   | 160         | 0,6         |
| <b>SF320</b>          | 8436017658637 | 18436017658634 | 21,0          | 38,0   | 6,5    | 6                   | 30,0           | 43,0   | 14,0   | 66     | 396   | 169         | 0,7         |
| <b>SF322</b>          | 8436017658644 | 18436017658641 | 8,0           | 23,0   | 39,5   | 6                   | 30,0           | 47,5   | 15,0   | 55     | 330   | 180         | 0,7         |
| <b>SF324</b>          | 8436017658651 | 18436017658658 | 8,5           | 25,0   | 43,5   | 6                   | 32,5           | 51,0   | 16,0   | 50     | 300   | 175         | 0,9         |
| <b>SF326</b>          | 8436017658668 | 18436017658665 | 6,0           | 27,0   | 45,5   | 6                   | 36,0           | 55,5   | 15,0   | 40     | 240   | 165         | 1,0         |
| <b>SF328</b>          | 8436017658675 | 18436017658672 | 9,5           | 29,0   | 47,5   | 6                   | 38,0           | 60,5   | 16,5   | 40     | 240   | 180         | 1,1         |
| <b>SF330</b>          | 8436017658682 | 18436017658689 | 8,0           | 31,0   | 50,0   | 6                   | 38,0           | 65,0   | 16,0   | 36     | 216   | 159         | 1,3         |
| <b>SF918</b>          | 8436584381075 | 18436584381072 | 6,5           | 19,0   | 36,0   | 6                   | 28,0           | 38,5   | 14,5   | 88     | 528   | 175         | 0,6         |
| <b>SF920</b>          | 8436584381082 | 18436584381089 | 8,0           | 21,0   | 38,5   | 6                   | 28,5           | 43,5   | 15,0   | 60     | 360   | 165         | 0,7         |
| <b>SF922</b>          | 8436584381099 | 18436584381096 | 8,0           | 23,0   | 40,5   | 6                   | 30,5           | 47,0   | 15,5   | 60     | 360   | 170         | 0,8         |
| <b>SF924</b>          | 8436584381105 | 18436584381102 | 8,0           | 25,0   | 44,0   | 6                   | 33,0           | 1,0    | 15,5   | 50     | 300   | 175         | 1,0         |
| <b>SF926</b>          | 8436584381112 | 18436584381119 | 8,0           | 27,0   | 45,0   | 6                   | 34,5           | 55,0   | 16,0   | 36     | 216   | 155         | 1,1         |
| <b>SF928</b>          | 8436584381129 | 18436584381126 | 9,0           | 29,0   | 47,5   | 6                   | 37,0           | 59,5   | 16,0   | 36     | 216   | 161         | 1,3         |
| <b>SF930</b>          | 8436584381136 | 18436584381133 | 8,5           | 31,0   | 49,5   | 6                   | 39,0           | 63,0   | 17,0   | 36     | 216   | 168         | 1,5         |
| <b>SMH14</b>          | 8436584381211 | 18436584381218 | 6,0           | 14,5   | 28,0   | 12                  | 30,5           | 34,0   | 29,0   | 30     | 360   | 173         | 0,2         |
| <b>TF924</b>          | 8436584381143 | 18436584381140 | 9,5           | 38,0   | 26,0   | 3                   | 29,0           | 40,0   | 31,0   | 40     | 120   | 170         | 1,7         |
| <b>TF928</b>          | 8436584381150 | 18436584381157 | 10,0          | 42,0   | 30,0   | 3                   | 32,5           | 43,5   | 32,0   | 30     | 90    | 175         | 2,2         |
| <b>IRONING BOARDS</b> |               |                |               |        |        |                     |                |        |        |        |       |             |             |
| <b>HPLA5213</b>       | 8436584382799 | 18436584382796 | 76,0          | 35,0   | 3,0    | 6                   | 17,5           | 76,0   | 36,5   | 24     | 144   | 161         | 1,6         |
| <b>HPLA8100</b>       | 8436584381655 | 18436584382406 | 6,0           | 40,5   | 147,0  | 2                   | 13,0           | 40,5   | 147,0  | 24     | 48    | 161         | 4,5         |
| <b>HPLA8102</b>       | 8436584381655 | 18436584381652 | 6,5           | 40,0   | 145,0  | 6                   | 45,0           | 42,5   | 151,0  | 4      | 24    | 167         | 4,5         |
| <b>HPLA8214</b>       | 8436584382904 | 18436584382901 | 76,0          | 35,0   | 3,0    | 6                   | 17,5           | 76,0   | 36,0   | 24     | 144   | 161         | 1,6         |
| <b>HPLA8241</b>       | 8436584385332 | 18436584385339 | 0,0           | 0,0    | 0,0    |                     | 0,0            | 0,0    | 0,0    | 0      | 0     | 0           |             |
| <b>HPLA8242</b>       | 8436584385325 | 18436584385322 | 0,0           | 0,0    | 0,0    |                     | 0,0            | 0,0    | 0,0    | 0      | 0     | 0           |             |
| <b>TM200</b>          | 8436017659320 | 18436017659327 | 11,0          | 54,0   | 4,0    | 6                   | 24,0           | 54,5   | 13,5   | 63     | 378   | 137         | 0,7         |
| <b>TM200R</b>         |               | 8436584383086  | 12,0          | 54,0   | 5,0    | 1                   | 12,5           | 54,0   | 6,5    | 208    | 208   | 119         | 0,7         |
| <b>TP500</b>          | 8436017659245 | 18436017659242 | 8,0           | 38,0   | 142,0  | 2                   | 15,0           | 38,0   | 143,0  | 18     | 36    | 158         | 5,3         |
| <b>TP520</b>          | 8436017659252 | 18436017659259 | 8,5           | 46,0   | 162,0  | 2                   | 16,5           | 46,0   | 162,0  | 12     | 24    | 178         | 6,4         |
| <b>TP550</b>          | 8436017659269 | 18436017659266 | 8,5           | 46,5   | 162,5  | 2                   | 16,5           | 46,5   | 162,5  | 12     | 24    | 179         | 8,5         |
| <b>TP600</b>          | 8436017659276 | 18436017659273 | 14,0          | 48,0   | 116,0  | 1                   | 16,5           | 50,0   | 118,0  | 10     | 10    | 113         | 9,4         |
| <b>848N</b>           | 8436017651966 | 8436017651966  | 8,0           | 34,0   | 123,5  | 1                   | 8,0            | 36,5   | 126,0  | 28     | 28    | 141         | 6,3         |
| <b>848S-01</b>        | 8436017653335 | 18436017653332 | 11,0          | 34,0   | 146,5  | 2                   | 21,0           | 148,0  | 36,5   | 10     | 20    | 163         | 6,9         |
| <b>CLOTHES LINES</b>  |               |                |               |        |        |                     |                |        |        |        |       |             |             |
| <b>HTEN2370</b>       | 8436584384595 | 18436584384592 | 4,5           | 54,5   | 131,0  | 6                   | 15,5           | 60,0   | 131,0  | 9      | 54    | 146         | 2,2         |
| <b>HTEN2375</b>       | 8436584384601 | 18436584384608 | 4,0           | 55,0   | 131,0  | 6                   | 15,5           | 60,5   | 132,0  | 9      | 54    | 147         | 1,7         |
| <b>HTEN2402</b>       | 8436584385110 | 18436584385117 | 3,0           | 58,5   | 36,5   | 6                   | 0,0            | 0,0    | 0,0    | 0      | 0     | 0           | 0,8         |
| <b>HTEN2403</b>       | 8421078038627 | 18421078038624 | 0,0           | 0,0    | 0,0    | 6                   | 0,0            | 0,0    | 0,0    | 0      | 0     | 0           |             |

| REFERENCE             | EAN13         | ITF14          | UNIT BOX (cm) |        |        | UNITS PER PACKAGING | PACKAGING (cm) |        |        | PALLET |       |             | WEIGHT (Kg) |
|-----------------------|---------------|----------------|---------------|--------|--------|---------------------|----------------|--------|--------|--------|-------|-------------|-------------|
|                       |               |                | WIDTH         | LENGTH | HEIGHT |                     | WIDTH          | LENGTH | HEIGHT | BOXES  | UNITS | HEIGHT (cm) |             |
| <b>THERMIC FLASKS</b> |               |                |               |        |        |                     |                |        |        |        |       |             |             |
| 825                   | 8436017658866 | 18436017658863 | 10,5          | 10,5   | 15,0   | 6                   | 24,0           | 34,5   | 17,0   | 63     | 378   | 134         | 0.51        |
| 826                   | 8436584380108 | 18436584380105 | 26,5          | 8,5    | 6,0    | 6                   | 26,0           | 19,5   | 29,0   | 84     | 504   | 150         | 0,3         |
| 827                   | 8436017658873 | 18436017658870 | 11,0          | 11,0   | 19,5   | 6                   | 23,5           | 34,0   | 21,5   | 54     | 324   | 152         | 0,6         |
| 834                   | 8436017659696 | 18436017659693 | 5,5           | 5,5    | 14,0   | 12                  | 22,0           | 26,5   | 18,0   | 96     | 1152  | 153         | 0,2         |
| 835                   | 8436017658507 | 18436017658504 | 7,5           | 7,5    | 21,5   | 6                   | 16,5           | 24,0   | 24,0   | 108    | 648   | 162         | 0,3         |
| 836                   | 8436017658514 | 18436017658511 | 6,5           | 6,5    | 25,0   | 6                   | 16,0           | 24,0   | 28,0   | 96     | 576   | 180         | 0,3         |
| 837                   | 8436017658521 | 18436017658528 | 8,5           | 8,5    | 29,0   | 6                   | 18,0           | 27,5   | 32,5   | 70     | 420   | 178         | 0,5         |
| 838                   | 8436017658538 | 18436017658535 | 9,0           | 9,0    | 32,5   | 6                   | 19,5           | 28,0   | 37,5   | 56     | 336   | 163         | 0,6         |
| 840                   | 8436017659702 | 18436017659709 | 9,2           | 9,2    | 21,2   | 6                   | 18,2           | 26,0   | 23,6   | 98     | 588   | 180         | 0,3         |
| 909                   | 8436017658040 | 18436017658047 | 7,5           | 7,5    | 19,0   | 6                   | 19,0           | 27,0   | 22,0   | 98     | 588   | 169         | 0,3         |
| 918                   | 8436017657746 | 18436017657743 | 17,0          | 24,5   | 23,5   | 6                   | 18,5           | 26,5   | 26,0   | 84     | 504   | 171         | 2,3         |
| 919                   | 8436017658057 | 18436017658054 | 8,5           | 8,5    | 26,5   | 6                   | 20,0           | 28,5   | 30,0   | 60     | 360   | 153         | 0,5         |
| 920                   | 8436017658064 | 18436017658061 | 9,0           | 9,0    | 31,5   | 6                   | 20,5           | 29,0   | 35,0   | 48     | 288   | 145         | 0,5         |
| 942                   | 8436017658781 | 18436017658788 | 21,5          | 21,5   | 13,5   | 6                   | 22,0           | 42,0   | 44,0   | 21     | 126   | 147         | 0,5         |
| 943                   | 8436017658798 | 18436017658795 | 21,5          | 21,5   | 17,5   | 6                   | 22,0           | 44,5   | 54,0   | 21     | 126   | 177         | 0,6         |
| HTER1001              | 8436584385219 | 18436584385216 | 0,0           | 0,0    | 0,0    | 10                  | 0,0            | 0,0    | 0,0    | 0      | 0     | 0           |             |
| HTER1011              | 8436584385226 | 18436584385223 | 0,0           | 0,0    | 0,0    | 10                  | 0,0            | 0,0    | 0,0    | 0      | 0     | 0           |             |
| HTER2100              | 8436584382706 | 18436584382703 | 11,0          | 14,0   | 29,0   | 6                   | 24,0           | 35,5   | 32,0   | 45     | 270   | 163         | 0,5         |
| HTER2125              | 8436584382676 | 18436584382673 | 9,5           | 11,0   | 21,5   | 6                   | 20,0           | 28,5   | 24,0   | 72     | 432   | 159         | 0,3         |
| HTER2150              | 8436584382683 | 18436584382680 | 9,0           | 10,5   | 24,5   | 6                   | 20,0           | 27,5   | 28,5   | 72     | 432   | 180         | 0,3         |
| HTER2175              | 8436584382690 | 18436584382697 | 10,0          | 12,0   | 27,5   | 6                   | 22,0           | 32,0   | 29,0   | 60     | 360   | 160         | 0,5         |
| HTER5500              | 8436584382027 | 18436584382024 | 7,0           | 8,0    | 25,0   | 6                   | 17,0           | 24,5   | 27,0   | 96     | 576   | 151         | 0,3         |
| HTER5501              | 8436584382034 | 18436584382031 | 7,0           | 8,0    | 25,0   | 6                   | 17,0           | 24,5   | 26,5   | 96     | 576   | 151         | 0,3         |
| <b>VINUM SERIES</b>   |               |                |               |        |        |                     |                |        |        |        |       |             |             |
| HBOX0122              | 8436584384144 | 8436584384144  | 29,0          | 62,0   | 43,0   | 1                   | 29,0           | 62,0   | 43,0   | 12     | 12    | 144         | 16,3        |
| HCON5408              | 8436584384946 | 18436584384943 | 2,5           | 11,0   | 20,0   | 12                  | 24,0           | 23,5   | 21,5   | 48     | 576   | 144         | 0,1         |
| HEXP2222              | 8436584384137 | 8436584384137  | 5,0           | 41,0   | 61,5   | 1                   | 5,0            | 41,0   | 61,5   | 132    | 132   | 180         | 2,2         |
| HVIN2200              | 8436584383963 | 18436584383960 | 1,0           | 11,0   | 20,0   | 24                  | 15,5           | 23,5   | 21,5   | 144    | 3456  | 161         | 0,0         |
| HVIN2201              | 8436584383314 | 18436584383311 | 5,5           | 5,5    | 28,5   | 6                   | 12,0           | 17,5   | 29,5   | 88     | 528   | 133         | 0,4         |
| HVIN2202              | 8436584383321 | 18436584383328 | 2,0           | 11,0   | 20,0   | 24                  | 24,5           | 23,0   | 21,0   | 96     | 2304  | 153         | 0,1         |
| HVIN2204              | 8436584383345 | 18436584383342 | 6,0           | 7,5    | 19,5   | 6                   | 16,5           | 19,0   | 20,5   | 160    | 960   | 173         | 0,3         |
| HVIN2205              | 8436584383352 | 18436584383359 | 4,0           | 9,0    | 18,5   | 6                   | 13,5           | 19,5   | 19,5   | 256    | 1536  | 171         | 0,2         |
| HVIN2206              | 8436584383369 | 18436584383366 | 5,0           | 6,5    | 16,0   | 12                  | 21,0           | 21,5   | 17,5   | 60     | 720   | 80          | 0,1         |
| HVIN2207              | 8436584383376 | 18436584383373 | 3,0           | 11,0   | 20,0   | 12                  | 12,5           | 32,0   | 21,0   | 144    | 1728  | 165         | 0,1         |
| HVIN2208              | 8436584383383 | 18436584383380 | 2,5           | 16,0   | 25,0   | 6                   | 17,0           | 17,0   | 26,0   | 128    | 768   | 151         | 0,5         |
| HVIN2212              | 8436584383970 | 18436584383977 | 2,0           | 11,0   | 20,0   | 24                  | 24,0           | 24,0   | 21,5   | 96     | 2304  | 153         | 0,1         |
| HVIN2215              | 8436584383987 | 18436584383984 | 4,0           | 11,0   | 20,0   | 12                  | 12,5           | 46,0   | 21,0   | 96     | 1152  | 165         | 0,1         |
| HVIN2300              | 8436584384564 | 18436584384561 | 5,0           | 11,0   | 22,0   | 12                  | 13,0           | 51,5   | 24,0   | 39     | 468   | 87          | 0,2         |
| HVIN2302              | 8436584384571 | 18436584384578 | 4,0           | 11,0   | 22,0   | 12                  | 13,0           | 47,0   | 24,0   | 39     | 468   | 87          | 0,2         |
| HVIN2314              | 8436584384410 | 18436584384417 | 6,0           | 6,5    | 18,5   | 12                  | 24,0           | 20,0   | 19,0   | 45     | 540   | 77          | 0,1         |
| HVIN2323              | 8436584384588 | 18436584384585 | 6,0           | 36,0   | 27,0   | 4                   | 28,0           | 36,5   | 24,5   | 24     | 96    | 89          | 1,4         |

Jata

Marco Aldany®



Feel the pleasure  
of a **pro** result.

**Pro**power  
**Pro**quality  
**Pro**satisfaction

**#Beautifyer.**  
The pleasure of feeling beautiful.

THE POWER OF  
**Beauty**







Iata

## PROFESSIONAL COLLECTION

PRODUCTS TESTED AND DESIGNED HAND  
BY HAND WITH HAIRDRESSERS

Marco  Aldany<sup>®</sup>  
THE POWER OF  
**Beauty**



**JBSC5577**

**Professional  
ionic dryer**

230 V - 2.000 W

**MOTOR BLDC**

- High performance BLDC motor with 110,000 RPM
- Ultralight.
- Reduction of drying time and frizz thanks to its ion generator
- Memory function: Remembers the last speed and temperature setting used
- Includes 1 diffuser and nozzles of 2 different sizes.
- Automatic filter cleaning function.
- LED indicator lights for operation.
- 3 speed positions 0 - 1 - 2.
- 3 heating positions: 1 - 2 - 3.
- Cold air button.
- Constant and powerful air flow.
- Cord length: 3 M.

||||| EAN 8421078038375  4 UNITS



**JBPP5570**

**Ceramic infrared rays  
hair straightener**

- Infrared ray function:
  - Facilitates the penetration of hair treatments.
  - Helps rebuild and soften the hair.
- Ceramic plates for an intensive hair care.
- Plate measures: 110 x 36 mm.
- Ionic function.
- Autosleep.
- Quick heat up.
- On / off switch.
- Temperature range: 100-230 °C.
- Pilot light.
- Ceramic resistance (PTC).
- Swivel cord. 3 meters.
- Temperature and Plate lock function.



**JBPC5544**

**Professional metal  
hair clipper**

100 - 240 V

- Cordless precision machine with adjusting device.
- Professional hairdressing and barbershop machine.
- Smart design with a special looking.
- High resistance stainless steel blades.
- Rechargeable battery Li-ion 2000 mAh
- Smart LED screen:
  - Battery remaining indicator.
  - Charging indicator.
- Cordless use 2.5 hours.
- Charging time 3 hours.
- Hairdresser attachments: lubricating oil, cleaning brush and comb.
- USB cable included.
- Blade control lever.
- 4 cutting guides: 1,5 - 3 - 6 - 9 mm.
- Accurate cutting.
- Blade protection.
- On / off switch.
- Hanging ring.

  
FUNCIÓN RAYOS  
INFRARROJOS

  
PLACAS  
CERÁMICAS

  
TECNOLOGÍA  
IÓNICA

  
CALENTAMIENTO  
ULTRARRÁPIDO

  
60 W

  
CORTAPELOS  
DE PRECISIÓN

  
CARGA  
POR USB

  
2,5 H. DE  
AUTONOMÍA

  
4 GUÍAS  
DE CORTE

  
CUCHILLAS  
ACERO INOX.

PRO SERIES

||||| EAN 8421078038429  6 UNITS

||||| EAN 8421078038412  4 UNITS

## PS33B Hair clipper / Body trimmer 7 in 1

100 - 240 V

- Cordless. 60 minutes use.
- Rechargeable. USB cable included.
- Quick charging battery: 2 hours.
- Waterproof. IPX5.
- 7 interchangeable accessories:
  - 2 head trimmers.
  - Shaver.
  - Nose trimmer.
  - Eyebrow and ear trimmer.
  - Multi-position cutting guide from 0 to 10 mm.
  - Multi-position cutting guide from 3 to 15 mm.
- Removable cutting unit for easy cleaning.
- High resistance stainless steel blades.
- On / off switch.
- Charging light indicator.
- Accurate cutting.
- Attachments included: comb, lubricating oil, cleaning brush.
- Tray support.

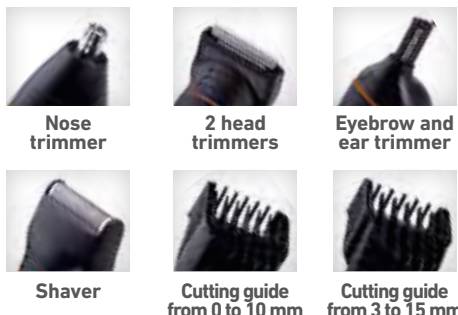

60 MIN. DE AUTONOMÍA  
7 CABEZALES DIFERENTES  
PROTECCIÓN AGUA IPX5

CUCHILLAS ACERO INOX.  
SIN CABLES

EAN 8421078034087  
12 UNITS

## MP59B Hair clipper 230 V

- Special for beard, moustaches and body trimmer.
- Cordless. 40 minutes.
- Rechargeable.
- 1 cutting guide / 20 positions: from 0,5 to 10 mm.
- Removable cutting unit for easy cleaning.
- High resistance blade.
- On / Off switch.
- Charging light indicator.
- Accurate cutting.
- Integrated and removable support.
- Hairdresser attachments included: lubricating oil, cleaning brush and charged cable.
- Ergonomic and light design.



CUCHILLAS ALTA RESISTENCIA  
SIN CABLES  
1 GUÍA DE CORTE 20 POSICIONES  
40 MIN. DE AUTONOMÍA

EAN 8421078034070  
12 UNITS

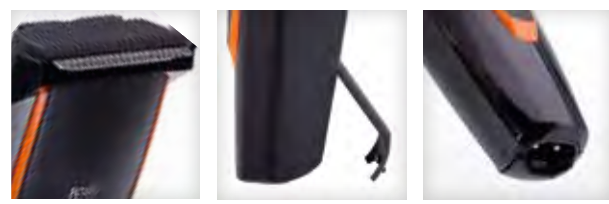

## JBMA1400 Rotary shaver 100 - 240 V

- Wet and dry shaving for maximum comfort
- Maximum accuracy of a single pass, three levels of adjustment.
- Shaving head rotation 360°, for an ergonomic shave that adapts to the contour of the face with great sensivity.
- Dual use, cord and cordless use, to guarantee the shaving.
- USB fast charging, included.
- Safety wet shaving due to IPX5. Suitable for using in the shower.
- Security lock.
- Lithium battery.
- Cordless working time 90 min.
- Charging time 120 min
- Big smart screen with battery indicator.
- Eayclean System with removable cutting heads.
- On / off switch.
- Charging light indicator.
- Attachments included: cleaning brush and protector cap.
- Charging base.



Shaving head rotation 360°

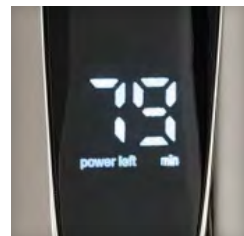

LED screen



Charging base



ROTACIÓN 360° PARA MAYOR PRECISION  
IPX5 APTO PARA SU USO EN DUCHA  
RECARGA RÁPIDA POR USB  
90 MIN. DE AUTONOMÍA

EAN 8421078036319  
6 UNITS

Spare parts  
RM34A  
EAN 8421078034971  
12 UNITS

**JBCP3700**



# Hair clipper

230 V

- Special for beard, moustaches and body trimmer.
- Dual use, cord and cordless use, to guarantee the shaving.
- Cordless working time 100 min.
- USB cable included.
- 1 cutting guide / 7 positions: from 3 to 21 mm.
- Removable cutting unit for easy cleaning.
- High resistance ceramic and stainless steel blades.
- Charging time 1,5 hours.
- On / Off switch.
- Charging light indicator.
- Smart led display with battery percentage display.
- Accurate cutting.
- Hairdresser attachments included: lubricating oil, cleaning brush and charged cable.

**JBCP3700**

||||| EAN 8421078038306

8 UNITS



Blade control lever

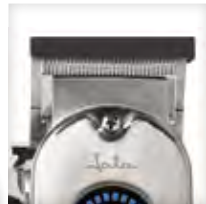

Blade protection



Smart led screen

**METAL**

**JBCP4000**

# Professional metal hair clipper

100 - 240 V

- Cordless precision machine with adjusting device.
- Professional hairdressing and barbershop machine.
- Smart design with a special looking.
- High resistance stainless steel blades.
- Rechargeable battery Li-ion 2000 mAh
- Smart LED screen:
  - Battery remaining indicator.
  - Charging indicator.
- Cordless use 2,5 hours.
- Charging time 3 hours.
- Hairdresser attachments: lubricating oil, cleaning brush and comb.
- USB cable included.
- Blade control lever.
- 4 cutting guides: 1,5 - 3 - 6 - 9 mm.
- Accurate cutting.
- Blade protection.
- On / off switch.
- Hanging ring.

PRO SERIES



||||| EAN 8421078036555

4 UNITS



**JBCP4200**

**Hair clipper / Body trimmer**

100 - 240 V

- 90 min of cordless use.
- Fast charging via USB (cable included)
- Dual use: connected to the power line and with battery.
- 5 cutting guides from 1 to 5 mm.
- Charging time: 1 hour.
- 600 mAh Lithium battery.
- High cutting precision. Special T-shaped blade for outlining and drawing.
- Smart led screen:
  - Shows the battery percentage.
  - Charging indicator light.
  - Time left.
- Accessories included: lubricating oil, brush for cleaning blades.



- A RED Y CON BATERÍA
- CARGA RÁPIDA POR USB
- 90' DE AUTONOMÍA
- 5 GUÍAS DE CORTE

||||| EAN 8421078037347 6 UNITS



5 cutting guides

2 head trimmers

Special nose and ears



- 99 MIN DE AUTONOMÍA
- CORTAPELOS DE PRECISIÓN
- CUCHILLAS ACERO INOX.
- RECARGA RÁPIDA POR USB
- 5 GUÍAS DE CORTE
- SOPORTE INCLUIDO

**JBCP3305**

**Hair clipper / Body trimmer 9 in 1**

100 - 240 V

- Fast USB charging, included in the case.
- Cordless working time 99 min.
- Charging time 1 hour.
- Safety wet shaving due to IPX6 protection. Suitable for shower.
- 9 interchangeable accessories:
  - 2 head trimmers.
  - Shaver.
  - Special trimmer for nose and ears.
  - 5 Multi-position cutting guide from 0 to 12 mm.
- Removable cutting unit for easy cleaning.
- Litium battery.
- High resistance stainless steel blades.
- Dual use, cord and cordless use, to guarantee your shaving.
- On / Off switch.
- Smart led screen:
  - Shows battery percentage.
  - Charging light indicator.
  - Security lock.
  - Cleaning display.
- Accurate cutting.
- Triple safety protection.
- Attachments included: comb, lubricating oil, cleaning brush.
- Tray support.

||||| EAN 8421078036326 6 UNITS

**JBCP3310**

**Hair clipper / Body trimmer**

100 - 240 V

- 2 hours of cordless shaving.
- Fast charging via USB (cable included)
- Dual use: connected to the network and with battery. 2 charging options.
- 5 cutting guides from 0 to 5 mm.
- Charging time 2 hours.
- Lithium battery.
- Stainless steel blades.
- High cutting precision.
- 2 speeds.
- Smart led screen:
  - Shows the battery percentage.
  - Charging indicator light.
  - Security lock.
- Accessories included: lubricating oil, brush for cleaning blades.

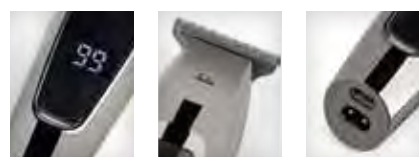

Smart led screen

Stainless steel blades

Fast charging via USB

- A RED Y CON BATERÍA
- CARGA RÁPIDA POR USB
- 2 HORAS DE AUTONOMÍA
- 5 GUÍAS DE CORTE

||||| EAN 8421078036333 6 UNITS



**JBSE2102**



**Hair clipper / Trimmer- shaver**

100 - 240 V

**HAIR CLIPPER**

- Cordless. 90 minutes use.
- Rotary control for different cutting measures.
- 2 cutting guides: 1 - 15 mm. / 16 - 30 mm.
- Protected against water splashing (IPX4)
- High resistance stainless steel blades.
- Smart LED screen:
  - Safety block indicator.
  - Battery remaining indicator.
  - Cutting measure indicator.
  - Charging light indicator.
  - Low battery indicator..
- Lithium battery.
- Charging time 120 min.
- On / off switch.
- Accurate cutting.
- Ergonomic and light design.
- Rechargeable.

**TRIMMER-SHAVER**

- Sin cable. Autonomía 90 minutos.
- Batería de litio.
- Gran precisión de corte.
- Cuchillas de acero inoxidable de alta resistencia.
- Botón encendido / apagado.
- 4 guías de corte de 3 a 12 mm.
- Tiempo de carga 120 min.
- Diseño ligero y ergonómico.
- Recargable.



**JBSE2102**

EAN 8421078036623

8 UNITS



**Hairdresser attachments included:** lubricating oil, cleaning brush and USB cord.

**JBCP3315**



**Shaver**

100 - 240 V

- Modern design.
- LED digital display.
- Displays: remaining charge percentage /
- low battery / charge indicator.
- Dual use: connected to the network and with battery.
- Fast USB charge (cable included)
- High resistance stainless steel blade
- 600mAh rechargeable lithium battery
- 3 cutting guides: 1-2-3 mm
- 1,5h Charging Time
- On/Off switch
- 80 minute autonomy
- Accessories included: lubricating oil, brush for cleaning blades.
- Multi-current 100-240 V.
- Remaining charge indicator.
- Low Battery indicator
- Charging indicator.



**JBCP3315**

EAN 8421078037323

6 UNITS



**JBCP3325**

**Professional shaver**

100 - 240 V

- Dual use, cord and cordless use, to guarantee the shaving.
- 4 cutting guide from 3 to 13 mm.
- Long-lasting professional motor.
- 3 adjustable speeds.
- Lithium battery.
- Blade protector.
- Cordless use time: 4h minimum power, 3,5 h medium power and 3,20h maximum power.
- Charging time 3,5 h.
- ON /OFF switch.
- Charge / low battery indicator light.
- Accessories included: blade cleaning brush, protective cap and lubricating oil.



- A RED Y CON BATERÍA
- CARGA RÁPIDA POR USB
- 4 GUÍAS DE CORTE
- 4 H. DE AUTONOMÍA MAX.

||||| EAN 8421078037330 6 UNITS



- CUCHILLAS ACERO INOX.
- SIN CABLES
- 3 GUÍAS DE CORTE
- 60 MIN. DE AUTONOMÍA

||||| EAN 8421078022893 12 UNITS

**MP373N**

**Hair clipper**

230 V

- Cordless. 60 minutes use.
- Telescopic system for cut length.
- Cutting guide innovator fixing system.
- 3 cutting guides: 0,5 - 2,5; 3 - 18; 21 - 36 mm.
- Beard accessory
- Variable thin out function.
- Removable cutting unit for easy cleaning.
- High resistance stainless steel blades.
- On / Off switch.
- Charging light indicator.
- Accurate cutting.
- Hairdresser attachments included: comb, adaptor, lubricating oil, cleaning brush.
- Charging base included.
- Ergonomic and light design.
- Rechargeable.
- AC / DC Adaptor: 230 V / 50 Hz (included).

**MP36B**

**Hair clipper**

100 - 240 V

- Works with battery and direct to the mains.
- Cordless. 50 minutes use.
- Rechargeable.
- Telescopic system for cut length.
- 2 cutting guides: 1 - 10 mm. / 11 - 20 mm.
- Removable cutting unit for easy cleaning.
- High resistance stainless steel blades.
- On / off switch.
- On and charging light indicator.
- Accurate cutting.
- Hairdresser attachments included: scissors, comb, adaptor, lubricating oil, cleaning brush.
- Ergonomic and light design.
- Multi current adaptor: 100 - 240 V (included).

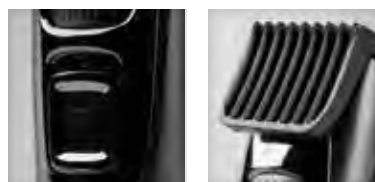

- A RED Y CON BATERÍA
- CORTAPELOS DE PRECISIÓN
- 50 MIN. DE AUTONOMÍA
- CUCHILLAS ACERO INOX.
- 2 GUÍAS DE CORTE

||||| EAN 8421078035695 12 UNITS





JBCP3538

AUTUMN  
NOVELTY



## Hair clipper / Body trimmer 5 in 1

MULTI-CURRENT FROM 100-240 V

- Cordless. 120 minutes use.
- Rechargeable. USB Type C cable included.
- Quick charging battery: 2 hours.
- **5 interchangeable accessories:**
  - Hair clipper.
  - Trimmer.
  - Hair profiler.
  - Special trimmer for nose and ears.
  - Shaver.
- 6 cutting guides: 1 - 2 - 3 - 6 - 9 - 12 mm.
- Removable cutting unit for easy cleaning.
- High resistance stainless steel blades.
- On / off switch.
- Charging light indicator.
- Attachments included: lubricating oil, cleaning brush.
- Tray support.



JBCP3538

EAN 8421078039020

8 UNITS

5 en 1  
5 ACCESORIOS  
INCLUIDOS

CARGA RÁPIDA  
POR USB

6 GUÍAS  
DE CORTE

120' DE  
AUTONOMÍA

**MP423**

**Hair clipper**

230 V

- Precision machine with adjusting device.
- High resistance stainless steel blades.
- Accurate cutting.
- Variable thin out function.
- Hairdresser attachments: scissors, comb, lubricating oil, cleaning brush.
- 4 cutting guides: 3, 6, 9, 12 mm.
- Blade protection.
- On / off switch.
- Removable cutting unit for easy cleaning.
- Hanging ring.

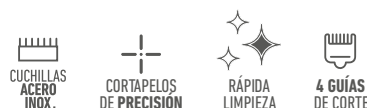

||||| EAN 8421078034858 8 UNITS



||||| EAN 8421078035763 12 UNITS

**CN12B**

**Trimmer**

- For nose, sideburn and ear.
- Safe and clean cut.
- Protected against water splashing (IPX4): Suitable for use in the shower.
- Removable cutting unit for easy cleaning.
- Integrated lighting for optimum vision.
- Ergonomic and light design.
- On / off switch.
- Accessories included: cleaning brush and base.
- Protective cover.
- Works with one "AA" battery of 1,5 V (not included).



**CN15B**

**Trimmer**

- For nose, ears and eyebrows.
- Stainless steel blade.
- Protected against water splashing (IPX4).
- On / off switch.
- 2 comb guides for trimmer. 2 cut lengths.
- Cleaning brush.
- Protective cover.
- Works with one "AA" battery of 1,5 V (not included).



28 UNITS  
DISPLAY BOXES  
16 x 22.5 x 31.5 cm



||||| EAN 8421078031154 2 x EXP / 14 UNITS



**JBSM1200**



**Manicure / Pedicure set 6 in 1**

- 6 professional accessories for manicure and pedicure.
- Progressive speed control.
- Double direction motor. Great power.
- Ergonomic and light design.
- Pilot lights.
- Rechargeable. USB cable included.
- Lithium battery.
- Magnetic box for storing and protecting accessories.

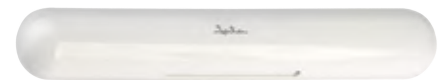

Professional manicure file set



**JBSM1200**

||||| EAN 8421078036340

6 UNITS



**DL87B**

**Callus remover / Lady shaver 2 in 1**  
100 - 240 V

- Works with battery and direct to the mains.
- Cordless. 60 minutes use.
- Rechargeable.
- 2 interchangeable heads:
  - Callus remover."
  - Epilator."
- Integrated lighting for optimum vision.
- On switch.
- Charging light indicator.
- Cleaning brush.
- Roll protector.
- Ergonomic and light design.
- Multi-current adaptor from 100-240 V (included).



||||| EAN 8421078032311 12 UNITS



**Spare parts**

**RL87B**

||||| EAN 8421078032489

12 UNITS



*Lata*



**JBSC1195**



## Ionic hair dryer

230 - Máx. 2.600 W

### MOTOR AC

- Great power.
- Universal air diffuser.
- Ionizer. Continuous ion generator.
- Overheating protection.
- Integrated independent knobs.
- Magnetic removable post filter.
- 3 speed positions 0 – 1 – 2.
- 3 heating positions: 1 – 2 – 3.
- Cold air button.
- Air flow 19.2 Mts/s
- Cord length: 2,80 M.
- Slim air concentrator.
- Hanging ring.



ION  
TECNOLOGÍA  
IÓNICA  
QUE ELIMINA EL  
ENCRESPAMIENTO

MOTOR AC ALTO  
RENDIMIENTO

DIFUSOR  
DE AIRE

LIMITADOR  
TÉRMICO  
DE SEGURIDAD

2.600 W  
MÁX.

||||| EAN 8421078038382  6 UNITS





**JBSC1065**

## Hair dryer

230 V - 2.200 W

### MOTOR AC

- Great power.
- Air diffuser.
- Overheating protection.
- Integrated independent knobs.
- Removable filter.
- 3 speed positions 0 –  – 
- 3 heating positions: 1 – 2 – 3.
- Cold air button.
- Slim air concentrator.
- Hanging ring.



CONCENTRADOR  
DE AIRE  
EXTRAPLANO

FILTRO  
POSTERIOR  
EXTRAIBLE

DIFUSOR  
DE AIRE

LIMITADOR  
TÉRMICO  
DE SEGURIDAD

2200 W

MOTOR AC ALTO  
RENDIMIENTO

||||| EAN 8421078036562  6 UNITS











# Ionic hair dryer

230 - Máx. 2.200 W

## MOTOR AC

- AC motor, high performance.
- Universal air diffuser.
- Frizz reduction thanks to the continuous ion generator.
- Overheating protection.
- Integrated independent knobs.
- 3 speed positions 0 – 1 – 2.
- 3 heating positions: 1 – 2 – 3.
- Cold air button.
- Air flow 17,3 Mts/s
- Cord length: 2,80 M.
- 2 different sizes nozzles 6/7.5 cm
- Hanging ring.



|   |  |   |
|---|--|---|
| <br><b>2.200 W</b>     | <br><b>MOTOR AC</b><br>ALTO RENDIMIENTO | <br><b>ION</b><br>TECNOLOGÍA<br>IÓNICA |
| <br>DIFUSOR<br>DE AIRE | <br>2 CONCENTRADORES<br>DE AIRE         | <br>LIMITADOR TÉRMICO<br>DE SEGURIDAD  |

JBSC1290

||||| EAN 8421078039037

 6 UNITS



**SC1013**

**Ionic hair dryer**  
**230 V - 2.000 W**

**MOTOR AC**

- Professional AC motor.
- Ionizer. Continuous ion generator.
- Overheating protection.
- Integrated independent knobs.
- 3 speed positions 0 – 1 – 2.
- 3 heating positions 1 – 2 – 3.
- Cold air button.
- Slim air concentrator.
- Air diffuser.
- Removable filter.
- Hanging ring.



||||| EAN 8421078027744 6 UNITS



**JBSC1430**

**Foldable hair dryer**  
**2.200 W**

**MOTOR DC**

- Ultra fast hair dryer.
- Folding handle system.
- Compact, light and powerful.
- Overheating protection.
- 3 switch positions: 0 – 1 – 2.
- Aesthetic and ergonomic design.
- Semi-rigid storage bag for transport.
- Includes microfiber turban towel.
- Cord length: 1,80 M.



INCLUDES CARRYING CASE + MICROFIBER TURBAN TOWEL

**JBSC1430**

||||| EAN 8421078037309

6 UNITS





## Wall hair dryer

230 V - 2.200 W

### MOTOR DC

- Ultra fast hair dryer.
- Compact, light and powerful.
- Power and safety button.
- 2 speed powers.
- 3 temperature levels.
- Removable filter for cleaning.
- Wall anchors.



JBSC1440

||||| EAN 8421078039044

📦 6 UNITS





**SC56B**

**Tourmaline dryer**  
**230 V - 2.000 W**

**MOTOR DC**

- Tourmaline technology for a healthier and more natural result.
- Overheating protection.
- Soft touch finishing.
- Integrated independent knobs.
- 3 speed positions 0 – 1 – 2.
- 3 heating positions 1 – 2 – 3.
- Air concentrator.
- Air diffuser.
- Cold air button.
- Back grid with opening system.
- Hanging ring.



- FILTRO POSTERIOR EXTRAIBLE
- DIFUSOR DE AIRE
- LIMITADOR TERMICO DE SEGURIDAD
- 2000 W

EAN 8421078033110 6 UNITS

**SC43B**

**Compact hair dryer**  
**230 V - 2.000 W**

**MOTOR DC**

- Compact design.
- Slim air concentrator.
- Overheating protection.
- 3 switch positions.
- Cold air button.
- Removable filter.
- Hanging ring.



- BOQUILLA PLANA
- FILTRO POSTERIOR EXTRAIBLE
- LIGERO Y ERGONOMICO

LIMITADOR TERMICO DE SEGURIDAD 2000 W

EAN 8421078035688 6 UNITS



**SC47B**

**Travel hair dryer**  
**110-230 V - 1.200 W**

**MOTOR DC**

- Foldable handle.
- Overheating protection.
- 3 switch positions: 0 – 1 – 2.
- Air concentrator.
- Air diffuser.
- Dual voltage.



- MANGO ABATIBLE
- DIFUSOR DE AIRE
- BITENSIÓN
- LIMITADOR TERMICO DE SEGURIDAD
- 1200 W

EAN 8421078034261 12 UNITS



## Smoothing brush / Ionic curling iron

50 W

- Two-height bristle design to facilitate hair straightening.
- Designed to give shape and movement to the hair.
- Quick heat up.
- Ceramic coating plate for an intensive hair care.
- Ionic technology to avoid frizziness.
- LED indicator light with 4 temperature levels: 160° / 180° / 200° / 220°
- On switch.
- Protector cover.
- Pilot light temperature range.
- Safety lock.
- Automatic sleep mode.
- Swivel cable. 2 meters.
- Hanging ring.



TECNOLOGÍA IÓNICA  
QUE EVITA EL  
ENCRESPAMIENTO

DISEÑO DE PÚAS  
A DOS ALTURAS

CALENTAMIENTO  
RÁPIDO

BLOQUEO  
DE SEGURIDAD

JBCA1901

EAN 8421078036616

6 UNITS



JBCA1901

## 3-in-1 Dryer brush: Styling and volumizing

230 V - 1.200 W

- 3 in 1: styler, volumizer and dryer.
- Ceramic coating.
- Ion generator that helps prevent frizz and add shine and softness to the hair.
- Overheating protection.
- 4 heating positions: 0- 1 – 2 – 3.
- Light weight.
- Hanging ring.



TECNOLOGÍA  
IÓNICA  
QUE ELIMINA EL  
ENCRESPAMIENTO

PESO LIGERO

BLOQUEO  
DE SEGURIDAD

1.200 W  
MÁX.

JBSC2211

EAN 8421078037354

6 UNITS

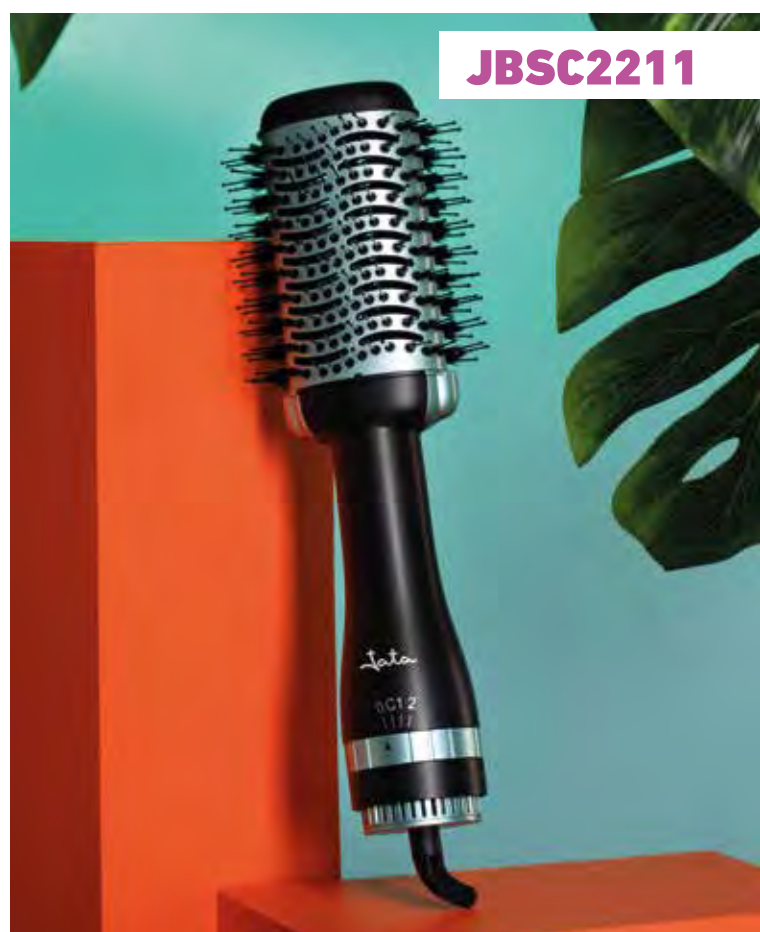

JBSC2211

**JBSE2101**



INCLUDES  
EXTRA SOFT  
FACIAL  
BRUSH



**Tourmaline ceramic hair straightener**

100-240 V - 42 W

**FLOATING TOURMALINE CERAMIC PLATES FOR AN INTENSIVE HAIR CARE**

- Single axis for a perfect alignment.
- Light on indicator and running.
- Metallic paint to provide a perfect glide.
- Quick heat up.
- Plates measures: 90 x 25 mm.
- 5 temperature positions. Maximum temperature 230 °C.
- PTC heating element.
- On / off switch.
- Auto shut off.
- Swivel cable cord 1,90 meters.

**GIFT FACIAL BRUSH**

- 350,000 soft and delicate PBT filaments for all skin types, including sensitive skin.
- Silicone brush head for use as an exfoliant in the nasal area.
- The protective cap acts as a hand holder for convenient cleaning.
- Ideal design, suitable for travel.

**TOURMALINE**  
PLACAS CERÁMICAS

**SISTEMA EASYCOMB**

**PLACAS CERÁMICAS FLOTANTES**

**230°**  
CALENTAMIENTO RÁPIDO

**BLOQUEO DE SEGURIDAD**

**40 W**



**JBSE2101**

||||| EAN 8421078036296

**6 UNITS**

**PP1065**



INCLUDES  
HEAT  
RESISTANT  
BAG

**Tourmaline ceramic hair straightener**

230 V - 37 W

- Tourmaline ceramic plates for an intensive hair care.
- Single axis for a perfect alignment.
- Metallic paint to provide a perfect glide.
- Quick heat up.
- Auto shut off.
- Plates measures: 95 x 30 mm.

- 4 temperature positions. Maximum temperature 200 °C.
- PTC heating element.
- On / off switch.
- Pilot light.
- Swivel cable cord 1,80 meters.
- Thermal pouch included.

**TOURMALINE**  
PLACAS CERÁMICAS

**185°C**  
TEMPERATURA OPTIMA

**PLACAS CERÁMICAS**

**PTC**  
RESISTENCIA CERÁMICA

**CALENTAMIENTO ULTRARRÁPIDO**

**37 W**



**PP1065**

||||| EAN 8421078035756

**4 UNITS**



**AUTUMN  
NOVELTY**

**JBPP1588**

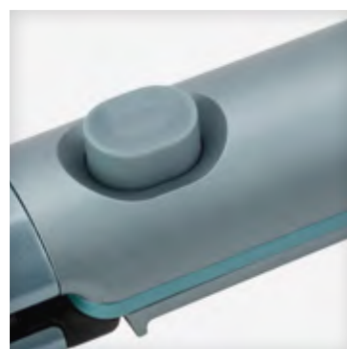

## Air hair straightener / Curler

100-240 V - 34 W

- Cool Air technology to fix and protect the curl.
- Floating ceramic plates.
- LED indicator light with 4 temperature levels: 140/160/180/200 °C
- Air function switch.
- On/Off switch.
- Memory function: Remembers the last temperature setting used.
- Safety lock.
- Auto shut off.
- Swivel cable. 2,5 meters.
- Hanging ring.
- Multi-voltage.



**JBPP1588**

||| EAN 8421078039051

6 UNITS





### HBAS1501

## Fitness analyser 180 kg, 7 FUNCTIONS

- **Analyses:**
  - Body muscle. - Body water.
  - Body fat. - Bone density.
  - Body mass index.
- **Informes:**
  - Suggested daily calories.
  - Body weight.
- 13 data memories.
- 6 mm. "temperit" safety glass base.
- Large "LCD" display. 4 digits.
- Touch sensor knobs.
- 4 sensors. High precision.
- Automatic switch on.
- Automatic switch off.
- Kg / lb / st. conversion function.
- Low battery indicator.
- Overweight indicator.
- Works with 1 CR2032 long life lithium battery (included).



33 x 33 x 2 cm

EAN 8436584381785 6 UNITS

### 531

## Fitness analyser 180 Kg, 6 FUNCTIONS

- **Analyses:**
  - Body muscle. - Body water.
  - Body fat. - Bone density.
- **Informes:**
  - Suggested daily calories.
  - Body weight.
- 12 data memories.
- 5 mm. "temperit" safety glass base.
- Large "LCD" display. 4 digits.
- 4 sensors. High precision.
- Automatic switch on.
- Automatic switch off.
- Kg / lb / st:lb. conversion function.
- Low battery indicator.
- Overweight indicator.
- Works with 2 "AAA" batteries of 1,5 V (not included).

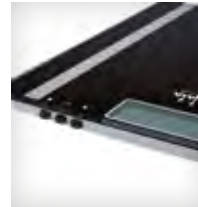

28 x 28 x 2,3 cm

EAN 8436017658088 6 UNITS

### 532

## Fitness analyser 180 Kg, 6 FUNCTIONS

- **Analyses:**
  - Body muscle. - Body water.
  - Body fat. - Bone density.
- **Informes:**
  - Suggested daily calories.
  - Body weight.
- 12 data memories.
- 5 mm. "temperit" safety glass base.
- Large "LCD" display. 4 digits.
- 4 sensors. High precision.
- Automatic switch on.
- Automatic switch off.
- Kg / lb / st:lb. conversion function.
- Low battery indicator.
- Overweight indicator.
- Works with 2 "AAA" batteries of 1,5 V (not included).



28x 28 x 2 cm

EAN 8436584380184 6 UNITS

80

## Body height meter with sensor

INFRARED SENSOR - 200 cm

- **Multi-function knob:**
  - On - Measuring.
  - Conversion function: cm. / in.
- "LCD" display. 4 digits.
- Low battery indicator.
- Automatic switch off.
- Works with 3 "AAA" batteries of 1,5 V (not included).

5 x 22 x 7 cm

EAN 8436017660104 9 UNITS



Infrared sensor. High accuracy.



9 UNITS DISPLAY BOXES  
19,2 x 31 x 23,8 cm



SENSOR  
INFRARED



538

## Rechargeable fitness analyser

USB WITHOUT BATTERIES, 7 FUNCTIONS

- Without batteries.
- Rechargeable battery: 2 hours full charge for using 6 months. USB cable included.
- **Analyses:**
  - Body muscle.
  - Body water.
  - Body fat.
  - Bone density.
  - Body mass index.
- **Inform:**
  - Suggested daily calories.
  - Body weight.
- 10 data memories.
- 5 mm. tempered safety glass base.
- Touch sensor knobs.
- Large "LED" display. 4 digits.
- Automatic switch on and switch off.
- Kg / lb conversion function.
- Overweight and low battery indicators.

29 x 24 x 1,8 cm

EAN 8436584380603 4 UNITS



USB cable included

577

## Fitness analyser **Bamboo**

180 Kg, 7 FUNCTIONS

- **Analyses:**
  - Body muscle.
  - Body water.
  - Body fat.
  - Bone density.
  - Body mass index.
- **Inform:**
  - Suggested daily calories.
  - Body weight.
- 10 data memories.
- Touch sensor knobs.
- Back light "LCD" display.
- Automatic switch off.
- Kg / lb / st. conversion function.
- Low battery indicator.
- Overweight indicator.
- Works with 2 "AAA" batteries of 1,5 V (not included).

34 x 27,5 x 3 cm

EAN 8436017658095 6 UNITS



**HBAS1524**

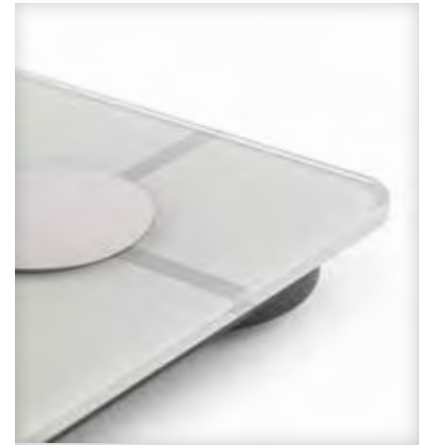

# Intelligent body analyzer with App

180 Kg, 13 FUNCTIONS

- Wireless connection compatible with iOS \* and Android devices.. OkOk International application.
- **Analyses:**
  - Body muscle.
  - Body water.
  - Body fat.
  - Bone density.
  - Body mass index.
  - Visceral fat.
  - Basal metabolic index.
  - Corporal mass low-fat index.
  - Metabolic age.
  - Rate of obesity.
  - Protein.
- **Informes:**
  - Weight.
  - Temperature.
- 8 data memories.
- 5 mm tempered safety glass base.
- Backlight "LCD display.
- Automatic switch on and switch off.
- Kg / lb conversion function.
- Overweight and low battery indicators.
- Works with 2 "AAA batteries of 1,5 V (not included).



**HBAS1524**

||| EAN 8436584384823

6 UNITS

30 x 30 x 2,1 cm



FREE APP OKOK INTERNATIONAL



# Intelligent body analyzer with App

180 Kg, 7 FUNCTIONS

- Compatible with devices with wireless connection 4.0 or higher and version 4.3 on Android or 8.0 IOS or higher. "Okok" application.
- **Analyses:**
  - Body muscle.
  - Body water.
  - Body fat.
  - Bone density.
  - Body mass index.
- **Inform:**
  - Weight.
  - Temperature.
- 15 data memories.
- 5 mm. "temperit" safety glass base.
- Large "LCD" display, 4 digits.
- 4 sensors. High precision.
- Automatic switch on.
- Automatic switch off.
- Kg / lb. conversion function.
- Low battery indicator.
- Overweight indicator.
- Works with 2 AAA 1.5 V batteries (not included).



**HBAS1155**

||| EAN 8436584385196

6 UNITS

28 x 28 x 2,3 cm





**HBAS1907**

**NOVEDAD  
OTOÑO**



## Scale WITHOUT BATTERIES

**U-POWER**  
Scale without batteries

- Technology without batteries or battery.
- U-Power: mechanical power generation.
- Capacity 150 kg.
- Graduation 100 g.
- 5 mm tempered safety glass base.
- 4 sensors. High precision.
- Large "LCD" display. 4 digits.
- Automatic switch off.
- Kg / lb conversion switch.
- Overweight indicator.

**HBAS1907**

||||| EAN 8436584385042

📦 6 UNITS

📦 28 x 28 x 4,2 cm

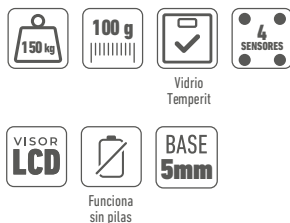

**6 UNITS DISPLAY BOXES**  
30 x 24 x 29 cm



535

## Scale **WITHOUT BATTERIES**

USB RECHARGEABLE

- Without batteries.
- **Rechargeable battery:** 2 hours full charge for using 6 months. USB cable included.
- 5 mm. tempered safety glass base.
- Large "LED" display. 4 digits.
- 4 sensors. High precision.
- Automatic switch on and switch off.
- Overweight and low battery indicators.



USB cable included



29 x 24 x 1,8 cm

EAN 8436584380610 4 UNITS



HBAS1499

## Scale **WITHOUT BATTERIES**



- Battery free technology.
- "U-Power": automatic energy generation.
- Capacity 150 kg.
- Graduation 100 g.
- 5 mm tempered safety glass base.
- 4 sensors. High precision.
- Large "LCD" display. 4 digits.
- Automatic switch off.
- Kg / lb conversion switch.
- Overweight indicator.

32 x 26 x 4,5 cm

EAN 8436584382232 4 UNITS

HBAS1417

## Electronic glass scale

MODERN DESIGN

- Large digits for easy reading of the measurement.
- LED display, red light.
- 4 sensors. High precision.
- Automatic switch on.
- Automatic switch off.
- Overweight indicator.
- Low battery indicator.
- Kg / lb / st. conversion switch.
- Works with 3 AAA batteries (not included).

30,2 x 30,2 x 2,5 cm

EAN 8436584383697 6 UNITS

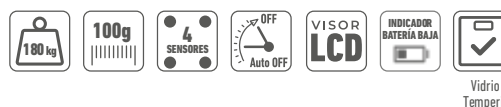

**HBAS1416**



EXTRA FLAT: 1 cm

**Electronic glass bathroom scale**  
**EXTRA-FLAT DESIGN**

- 6 mm Temperit safety glass base.
- Large LCD display. 4 digits.
- 4 sensors. High precision.
- Automatic switch on.
- Automatic switch off.
- Overweight indicator.
- Low battery indicator.
- Kg / lb / st. conversion switch.
- Works with 2 CR2032 long life lithium batteries (included).



**HBAS1416**

||||| EAN 8436584382652

📦 4 UNITS

📦 31 x 31 x 1 cm

**EXTRA FLAT**

**517**

**Electronic bathroom talking scale**

- Exclusive talking system.
- 5 mm. "temperit" safety glass base.
- Back light "LCD" display.
- Automatic switch off.
- Overweight indicator.
- Low battery indicator.
- Kg / lb / st conversion switch.
- Works with 2 "AAA" batteries of 1,5 V (not included).



**ALSO WITHOUT VOICE**

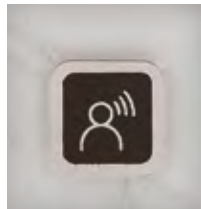

**TALKING SCALE:**  
spanish, english and portuguese.



**Back light "LCD" display.**



📦 28 x 28 x 2 cm

||||| EAN 8436584380122

📦 6 UNITS

## Electronic bathroom scale

### GLASS WITH MARBLE DESIGN

- 5 mm. tempered Temperit safety glass base.
- Large LCD display. 4 digits.
- 4 sensors. High precision.
- Automatic switch on.
- Automatic switch off.
- Overweight indicator.
- Low battery indicator.
- Kg / lb. conversion switch.
- Works with 1 CR2032 long life lithium battery (included).

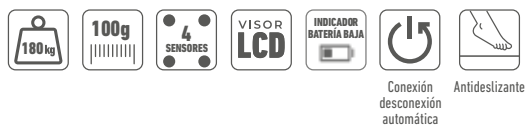

**HBAS1415**

||||| EAN 8436584382645

📦 6 UNITS

📏 34 x 30 x 2 cm

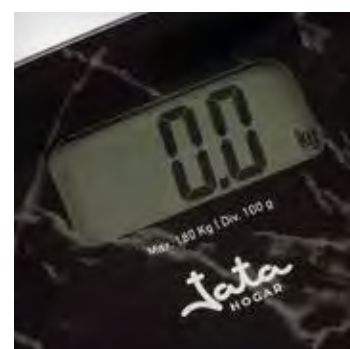

## 294K / 295K

### Bathroom scale

#### GLASS

- 5 mm. tempered safety glass base.
- Large "LCD" display. 4 digits.
- 4 sensors. High precision.
- Automatic switch on.
- Automatic switch off.
- Overweight indicator.
- Low battery indicator.
- Kg / lb / st. conversion switch.
- Works with 1 CR2032 long life lithium battery (included).



**KUKUXUMUSU®**



**294K**



**295K**



**6 UNITS  
DISPLAY BOXES  
31,6 x 17 x 32,1 cm**



| 294K              | 295K              |
|-------------------|-------------------|
| EAN 8436584381013 | EAN 8436584381020 |
| 📦 6 UNITS         | 📦 6 UNITS         |
| 📏 30 x 30 x 2 cm  | 📏 30 x 30 x 2 cm  |

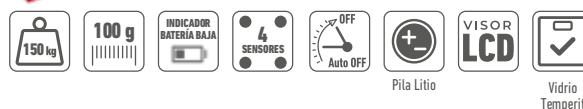





Sustainable bamboo production, 12 mm thickness



489

Electronic bathroom scale **Bamboo**  
SUSTAINABLE BAMBOO PRODUCTION

- Sustainable bamboo production, 12 mm. thickness.
- Large "LCD" display. 4 digits.
- 4 sensors. High precision.
- Automatic switch on.
- Automatic switch off.
- Overweight indicator.
- Low battery indicator.
- Lb - Kg conversion switch.
- Works with 2 AAA batteries (not included) - 1,5V.

29,5 x 29,5 x 2,3 cm

EAN 8436584380146

6 UNITS

498

Electronic bathroom scale  
WOOD, WITH ENVIRONMENTAL THERMOMETER

- "HPL" surface:
  - High resistance laminate.
  - Ideal for wet places.
- Informs: weight and environment temperature.
- Backlight "LCD" display.
- 4 sensors. High precision.
- Overweight indicator.
- Low battery indicator.
- Kg. / lb. conversion switch.
- Works with 2 CR2032 long life lithium batteries (included).



29,5 x 29,5 x 2,2 cm

EAN 8436017659627

6 UNITS



496N

Electronic bathroom scale  
WITH ENVIRONMENTAL THERMOMETER

- Anti-fingerprint stainless steel surface.
- Informs: weight and environment temperature.
- Backlight "LCD" display.
- 4 sensors. High precision.
- Automatic switch on.
- Automatic switch off.
- Overweight indicator.
- Low battery indicator.
- Kg. / lb. conversion switch.
- Works with 2 CR2032 long life lithium batteries (included).

29,5 x 29,5 x 2 cm

EAN 8436017659610

6 UNITS

**290N / HBAS1290**

**Electronic bathroom scale**

GLASS

- 6 mm. tempered safety glass base.
- Large "LCD" display. 4 digits.
- 4 sensors. High precision.
- Overweight indicator.
- Low battery indicator.
- Kg / lb / st. conversion switch.
- Works with 1 CR2032 long life lithium battery (included).

**290N - BLACK**

||||| EAN 8436017659962

📦 6 UNITS

📦 30 x 30 x 2 cm

**HBAS1290 - TURQUOISE**

||||| EAN 8436584382553

📦 6 UNITS

📦 30 x 30 x 2 cm



**290N**

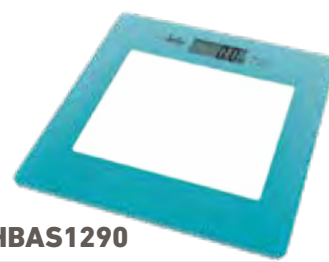

**HBAS1290**



**6 UNITS DISPLAY BOXES**  
32,5 x 21,8 x 32,2 cm

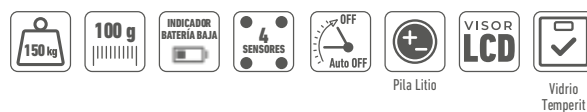

**Electronic bathroom scale**

TEMPERED GLASS

- Thickness of glass plate: 5mm tempered glass
- Large LCD display. 4 digits.
- 4 sensors. High precision.
- Automatic switch on, Step on technology.
- Automatic switch off.
- Overweight indicator.
- Low battery indicator.
- Kg / lb / st. conversion switch.
- Works with 2 AAA batteries (not included).



**6 UNITS DISPLAY BOXES**  
30 x 20 x 29 cm



**HBAS1291 - RED**

||||| EAN 8436584384977

📦 6 UNITS

📦 28 x 28 x 2 cm

**HBAS1292 - SILVER**

||||| EAN 8436584384984

📦 6 UNITS

📦 28 x 28 x 2 cm



**HBAS1291 / HBAS1292**





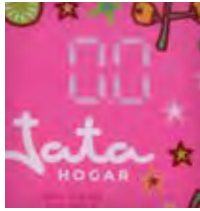

**HBAS1424**

**Electronic bathroom scale**  
GLASS

- Thickness of glass plate: 5mm tempered glass
- Large digits for easy reading of the measurement.
- Backlight LCD display.
- 4 sensors. High precision.
- Automatic switch on, Step on technology.
- Automatic switch off.
- Overweight indicator.
- Low battery indicator.
- Kg / lb conversion switch.
- Works with 3 AAA batteries (not included).



**KUKUXUMUSU®**

30 x 30 x 2,1 cm

EAN 8436584384694

6 UNITS

**HBAS1492**

**Scale**  
USB RECHARGEABLE

- Without batteries.
- Rechargeable battery: 2 hours full charge for using 3 months. USB cable included.
- Thickness of glass plate: 5mm tempered glass
- Kg / lb conversion switch.
- Back light LCD display.
- 4 sensors. High precision.
- Automatic switch on and switch off.
- Overweight and low battery indicators.

29 x 26 x 1,5 cm

EAN 8436584384700

6 UNITS



6 UNITS DISPLAY BOXES  
301 x 156 x 270 mm



USB RECHARGEABLE



**70**

**Mechanical bathroom scale**  
WHITE - 130 Kg

- Big size surface.
- Great resistance epoxy paint body.
- Easy cleaning.
- Easy reading large dial.
- Manual adjustment.

30 x 27,5 x 5,3 cm

EAN 8436584380627

6 UNITS



CT10 / CT20 / JCAE5220 / JCAE5422 / CT30

Heating pad

230 V - 100 W

- Electronic regulator knob with 6 heating levels.
- Security auto shut off (90 minutes).
- Quick heating function.
- Pad totally flexible, soft and breathable.
- Removable and washable textile cover.
- Pilot light.

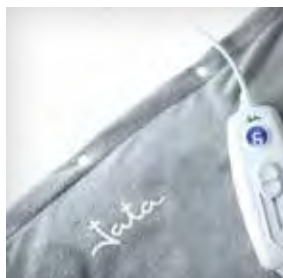

**CT10**

||||| EAN 8421078032205

📦 6 UNITS

📦 40 x 30 cm

**CT20**

||||| EAN 8421078032212

📦 6 UNITS

📦 50 x 40 cm

**JCAE5220**

||||| EAN 8421078036463

📦 6 UNITS

**JCAE5422**

||||| EAN 8421078037422

📦 6 UNITS



CT10 / CT20



JCAE5220



JCAE5422

**Especialmente indicadas para lesiones deportivas, dolores reumáticos, menstruales, etc.**

*Especialmente indicado para lesões desportivas, dores reumáticas, menstruais, etc.*

*Epecially indicated for sports injuries, rheumatic pain, menstrual pain...*

**CT30**

||||| EAN 8421078032229

📦 6 UNITS

📦 65 x 43 cm

**Almohadilla eléctrica cervical. Especialmente indicada para dolores de espalda y cervicales.**

*Almofada eléctrica cervical. Especialmente indicado para dores de costas e dores cervicais.*

*Cervical electric pad. Especially indicated for back and neck pain.*



CT30



Thinking of a better home.  
Thinking of you.

[www.jata.es](http://www.jata.es)

History, guarantee and quality since 1943.





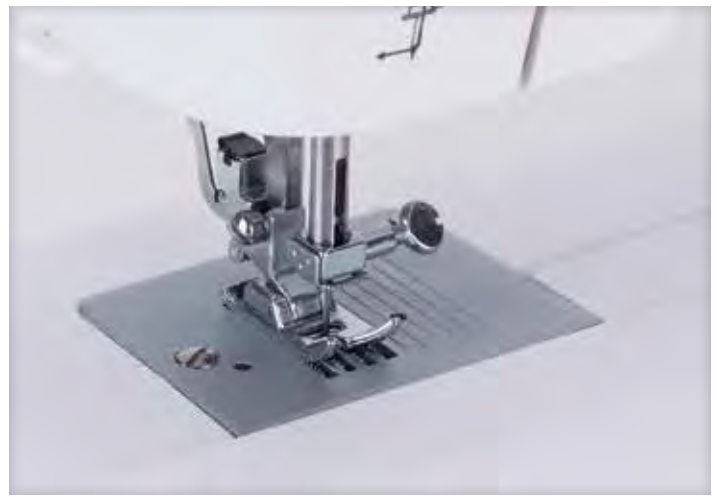

**SEWING**





**MC695**

||||| EAN 8421078028864

📦 1 UNIT

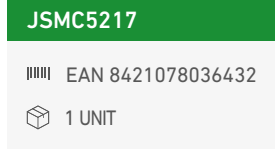

**JSMC5217**

||||| EAN 8421078036432

📦 1 UNIT

-  13 DISEÑOS DE PUNTADA
-  ACCESORIOS INCLUIDOS
-  OJAL EN 4 TIEMPOS
-  70 W

## MC695 / JSMC5217 Sewing machine 70 W

- 13 design patterns.
- Double needle.
- 8 accessories included: bobbin, seam ripper, spool pin disc, buttonhole foot, needles, twin-needle, spool pin, screwdriver.
- 4-step button holes.
- Oscillating hook system.
- Double height foot.
- Automatic bobbin winding.
- 2 spool pins.

*Genesis*

- Free arm.
- "Z" stitch.
- Reverse function.
- Foot pedal included.
- Portable.
- Lamp included 15 W.
- Transport handle.
- Set of accessories included.
- Soft protective cover.

📦 34 x 15 x 26 cm    📖 5,96 Kg

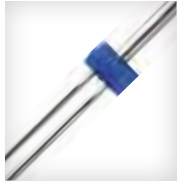

## MC744 Sewing machine 60 W

*Selección*  
744

- 66 design patterns.
- 4-step button holes.
- Double height foot.
- 2 spool pins.
- Changing presser foot.
- Double needle function. Needle included.
- Selected stitch indicator.
- Automatic bobbin winding.

- Free arm.
- "Z" stitch.
- Reverse function.
- Incorporated motor 60 W.
- Lamp included.
- Portable.
- Foot pedal included.
- Transport handle.
- Set of accessories included.

📦 42 x 22 x 34 cm    📖 7,10 Kg

||||| EAN 8421078033981    📦 1 UNIT

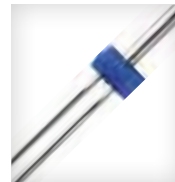

-  66 DISEÑOS DE PUNTADA
-  OJAL EN 4 TIEMPOS
- FUNCIÓN DE DOBLE AGUJA**
-  60 W



## MC740 Sewing machine 60 W

*Selección*  
740

- 66 design patterns.
- 4-step button holes.
- Double height foot.
- 2 spool pins.
- Changing presser foot.
- Double needle.
- Selected stitch indicator.
- Automatic bobbin winding.
- Free arm.

- Reverse function.
- "Z" stitch.
- Incorporated motor 70 W.
- Portable.
- Lamp included.
- Foot pedal included.
- Transport handle.
- Set of accessories included.

📦 36 x 17 x 28 cm    📖 7,10 Kg

||||| EAN 8421078032182    📦 1 UNIT

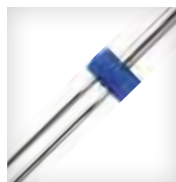

-  66 DISEÑOS DE PUNTADA
-  OJAL EN 4 TIEMPOS
- FUNCIÓN DE DOBLE AGUJA**
-  60 W



AUTUMN  
NOVELTY

**JSMC1120**

## Electronic sewing machine

*Stitch Master*

36 W

- Electronic intelligent control of functions.
- **270 design patterns:**
  - 100 alphanumeric stitches and signs.
  - 91 deco stitches.
  - 71 double stitch.
  - 8 automatic button holes.
- Sew button.
- Dual use: with pedal and without pedal.
- Back light "LCD" display.
- Security auto shut off.
- Double needle.
- 2 spool pins.
- Sewing speed control.
- Needle position / reverse stitch button.
- Upper thread tension adjustment.
- Changing presser foot.
- Double height foot.
- Double feed dog.
- Strong for heavy fabric.
- Auto threader.
- Free arm.
- Automatic bobbin winding.
- One reverse stitch button.
- Lamp included.
- Portable.
- Foot pedal included.
- Transport handle.
- Set of accessories included.

JSMC1120

||||| EAN 8421078038993

📦 1 UNIT

📏 40 x 13 x 31 cm 📊 4,885 Kg





## MC823

### Electronic sewing machine

36 W

*Supra*  
823

- Electronic intelligent control of functions.
- 200 design patterns:
  - 13 flexi stitches.
  - 62 deco stitches.
  - 16 satin stitches.
  - 10 numerical stitches.
  - 90 alphabet and sign stitches.
  - 8 automatic button holes.
  - Sew button.
- Back light "LCD display.
- Security auto shut off.
- Oscillating hook system.
- Double needle.
- 2 spool pins.
- Changing presser foot.
- Double height foot.
- Double feed dog.
- Strong torque for a heavy fabric.
- Auto threader.
- Free arm.
- Automatic bobbin winding.
- One reverse stitch button.
- Lamp included.
- Portable.
- Foot pedal included.
- Transport handle.
- Set of accessories included.



GESTIÓN ELECTRÓNICA



DESCONEXIÓN AUTOMÁTICA



200 DISEÑOS DE PUNTADA



13 ACCESORIOS INCLUIDOS



OJAL EN 4 TIEMPOS



FUNCIÓN DE DOBLE AGUJA



40 x 18 x 29 cm



6,63 Kg



EAN 8421078032168



1 UNIT

## OL902

### Overlock / Sewing machine

90 W

*Solid overlock*  
902

- Stitch functions 2, 3 and 4 threads.
- 1 or 2 needles.
- Differential feed.
- Security stitch.
- Lateral cutting.
- Adjustable stitch width and length.
- Changing presser foot.
- Color codes for threading.
- Free arm.
- Incorporated motor 90 W.
- Portable.
- Lamp included.
- Foot pedal included.
- Transport handle.
- Set of accessories included.
- Soft protective cover.



30 x 26 x 28 cm



8,24 Kg



EAN 8421078033998



1 UNIT



GESTIÓN ELECTRÓNICA



LÁMPARA LED INTEGRADA

1y2

AGUJAS



90 W



## AC45

### Sewing box

- Accessories:
  - 9 big spools of thread.
  - 150 cm. tape measure.
  - 1 needle threader.
  - 1 thimble.
  - 5 sewing machine needles.
  - 5 plastic bobbins.
  - 100 colour pins.
  - 1 seam ripper.
  - 1 scissor.
- Compact size.
- Transport handle.
- Handle with inner compartment.
- Two stands for vertical storage.



34 x 15 x 26 cm



5,96 Kg



EAN 8421078032328



4 UNITS









**PL120**

**Steam iron**

230 V - 2.200 W

- Stainless steel sole plate.
- Detachable anti-calc needle.
- Vertical steam.
- Adjustable steam.
- Independent buttons: burst steam / spray.

*Small iron with a lot of power*

- Adjustable thermostat of temperature.
- Translucent water tank with safety lid.
- Pilot light.
- 360° pivoting cord.

Steam rate 20-25 g/min



||||| EAN 8421078033486

📦 6 UNITS

**CAJA EXPOSITORA 6 ud.**  
235 x 435 x 325 mm.

**PL225**

**Steam iron**

230 V - Máx. 2.200 W

- Stainless steel sole plate.
- Adjustable steam.
- Vertical steam.
- Anti-calc function.
- Anti-drip.
- Auto-cleaning.
- Independent buttons: burst steam / spray.
- Adjustable thermostat of temperature.
- Translucent water tank with safety lid.
- Pilot light.
- 360° pivoting cord.

Steam rate 20-25 g/min  
Burst of steam 160 g/min



||||| EAN 8421078034841

📦 6 UNITS

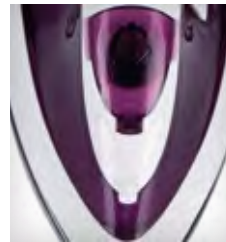

**PL221C**

**Ceramic steam iron**

230 V - Máx. 2.400 W

- Ceramic sole plate.
- Vertical steam.
- Auto-cleaning.
- Anti-drip.
- Anti-calc permanent.
- Adjustable steam.
- Independent buttons: burst steam / spray.
- Adjustable thermostat of temperature.
- Pilot light.
- Water tank with safety lid.
- Water tank capacity 350 ml.
- 360° pivoting cord.

Steam rate 20-30 g/min  
Burst of steam 160 g/min



||||| EAN 8421078033493

📦 6 UNITS





## Ceramic steam iron

230 V - 2.200 W

- Ceramic sole plate.
- Vertical steam.
- Auto-cleaning.
- Anti-drip.
- Anti-calc permanent.
- Adjustable steam.
- Independent buttons: burst steam / spray.
- Adjustable thermostat of temperature.
- Pilot light.
- Water tank with safety lid.
- Water tank capacity 200 ml.



Steam rate 15 g/min  
Burst of steam 180 g/min



JEPL2241

EAN 8421078038962

6 UNITS



**JEPL1221**

**Ceramic steam iron**

230 V - 2.400 W

- Ceramic sole plate.
- Vertical steam.
- Auto-shut off.
- Auto-cleaning.
- Anti-drip.
- Anti-calc permanent.
- Adjustable steam.
- Independent buttons: burst steam / spray.
- Adjustable thermostat of temperature.
- Pilot light.
- Water tank with safety lid.
- Water tank capacity 350 ml.
- 360° pivoting cord.

Steam rate 20-30 g/min  
Burst of steam 160 g/min



||||| EAN 8421078038337

📦 6 UNITS

**PL618**

**Steam iron**

230 V - 2.600 W

- Stainless steel soleplate: uniform temperature, optimum steam.
- Anti-drip.
- Auto-cleaning.
- Anti-calc permanent.
- Vertical steam.
- Independent buttons: burst steam / spray.
- Adjustable steam.
- Rubberised handle.
- Adjustable thermostat of temperature.
- Indicator light.
- Water tank capacity 300 ml.
- Water tank with safety lid.
- Pivoting cord.

Steam rate 40 g/min  
Burst of steam 200 g/min



||||| EAN 8421078032397

📦 6 UNITS



**PL598C**

**Ceramic steam iron**

230 V - 2.600 W

- Ceramic sole plate.
- Vertical steam.
- Auto-cleaning.
- Anti-drip.
- Anti-calc permanent.
- Adjustable steam.
- Independent buttons: burst steam / spray.
- Adjustable thermostat of temperature.
- Pilot light.
- Water tank with safety lid.
- Water tank capacity 350 ml.
- 360° pivoting cord.

Steam rate 20-30 g/min  
Burst of steam 190 g/min



||||| EAN 8421078035428

📦 6 UNITS

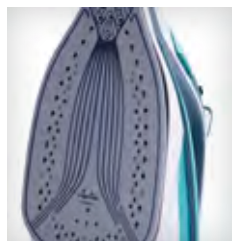



**PL622C****Ceramic steam iron**

230 V - 3.000 W

- Ceramic sole plate.
- Vertical steam.
- Auto-cleaning.
- Anti-drip.
- Anti-calc permanent.
- Adjustable steam.
- Independent buttons: burst steam / spray.
- Adjustable thermostat of temperature.
- Pilot light.
- Water tank with safety lid.
- Water tank capacity 360 ml.
- 360° pivoting cord.

Steam rate 50 g/min  
Burst of steam 220 g/min



||||| EAN 8421078035435

📦 6 UNITS

**Ceramic steam iron****PRO SERIES**

230 V - 3.000 W

- Ceramic soleplate.
- Auto-shut off.
- Anti-drip.
- Auto-cleaning.
- Anti-calc permanent.
- Vertical steam.
- Independent buttons: burst steam / spray..
- Adjustable steam.
- Rubberised handle.
- Adjustable thermostat of temperature.
- Auto shut-off indicator light.
- Power on indicator light.
- Water tank capacity 400 ml.
- Water tank with safety lid.
- Pivoting cord.

Steam rate 50 g/min  
Burst of steam 220 g/min

**PL1058C**

||||| EAN 8421078035381

📦 6 UNITS

**PL1058C**



**JEPL2401**

**AUTUMN NOVELTY**



## Ceramic steam iron

230 V - 3.000 W

- Ceramic sole plate.
- Vertical steam.
- Auto-cleaning.
- Anti-drip.
- Anti-calc permanent.
- Adjustable steam.
- Independent buttons: burst steam / spray.
- Adjustable thermostat of temperature.
- Pilot light.
- Water tank with safety lid.
- Water tank capacity 450 ml.
- 360° pivoting cord.

**JEPL2401**

||| EAN 8421078038948

6 UNITS

SUELA CERÁMICA

VAPOR VERTICAL

AUTO LIMPIEZA

ANTI GOTEO

450 ML

3000 W

CAPACIDAD DEPÓSITO

Steam rate 20-25 g/min  
Burst of steam 220 g/min

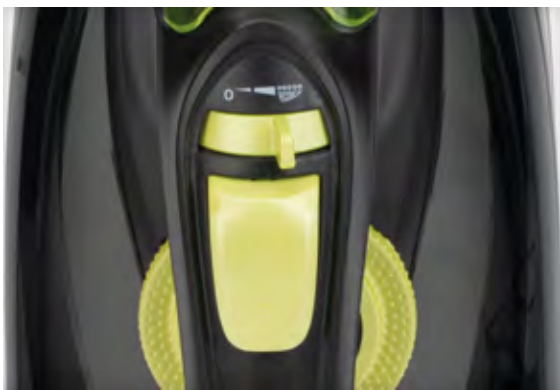

## Ceramic steam iron

230 V - 3.000 W

- Ceramic soleplate.
- Auto-shut off.
- Anti-drip.
- Auto-cleaning.
- Anti-calc permanent.
- Vertical steam.
- Independent buttons: burst steam / spray.
- Adjustable steam.
- Adjustable thermostat of temperature.
- Power on indicator light.
- Water tank capacity 350 ml.
- Water tank with safety lid.
- Pivoting cord.



Steam rate 29 g/min  
Burst of steam 220 g/min



JEPL3242

EAN 8421078039013

6 UNITS

**JEPL7000**



**Vertical steam iron**

230 V - Máx. 1.630 W

- Ceramic sole plate.
- ON / OFF Switch
- Adjustable vertical steam.
- Removable water tank capacity 300 ml.
- LED side light indicator.
- Adjustable steam control with locking function.
- Constant steam 20 – 25g/min
- Ceramic steam head.
- Brush for thick fabrics.
- Heating in 30 s.
- Safety auto-off.
- Cord 1,8 M



**JEPL7000**

||||| EAN 8421078036272

4 UNITS



DEPÓSITO EXTRAÍBLE

**JEPL2810**

**Travel steam iron**

110 / 230 V - 1.000 W

- Ceramic sole plate.
- Dual voltage.
- Super steam.
- Foldable handle.
- Adjustable thermostat of temperature.
- Water level display.
- Pilot light.
- Length cord 190 cm.
- Plastic container 75 ml.



||||| EAN 8421078037101

10 UNITS

**PL357N**

**Travel steam iron**

230 V - 800 W

- Stainless steel sole plate.
- Dual voltage.
- Foldable handle.
- Adjustable thermostat of temperature.
- Water level display.
- Pilot light.
- Textile travel bag.



||||| EAN 8421078027041

12 UNITS



## Compact steam station

230 V - 3.200 W

- Same performance as 7 bar boiler system.
- Continuous steam 140g/min.
- Refilling water tank.
- **Control panel:**
  - Auto power off indicator.
  - ECO steam.
  - Standard steam.
  - Sel-cleaning indicator.
  - Recharge indicator..
- SCeramic sole plate.
- Auto-off function in 10 min.
- Vertical ironing.
- Overheating safety device.
- Plate rest with safety lock.
- Steam hose storage.
- Steam hose length 1,5 m
- Modern and compact design.
- Self-cleaning system.
- Water tank capacity 1,7 L
- 200 ml. Graduated container.



CAPACIDAD DEPÓSITO

**JECP8522**

||||| EAN 8421078037057

📦 2 UNITS



**JECP8522**

## Steam station

230 V - 2.250W

- Ceramic soleplate.
- Plate rest with safety lock.
- Steam button.
- Vertical steam.
- Anti-limescale filter.
- Anti-drip.
- Steam rate 40 – 60 g/min.
- Steam cord storage.
- Adjustable thermostat of temperature.
- 1.1 L translucent water tank with safety lid.
- Continuous steam.
- Pilot light.
- Steam hose length 1,60 m
- Cord length: 1,97 M.



CAPACIDAD DEPÓSITO

**JECP8523**

||||| EAN 8421078038108

📦 2 UNITS



**JECP8523**



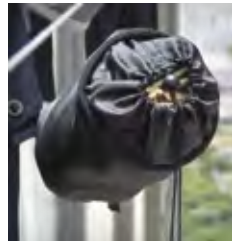

**HPLA8000 / HPLA5211**

**Bag for tweezers cloth**



- Capacity for 100/150 tweezers.
- Protects the tweezers from sunlight and rain.
- Perfect organizer, for indoor and outdoor.
- Made of polyester, great weather resistance.
- Aluminum buckle to hold on ropes, clotheslines or wall.
- Cord for opening and closing regulation.
- Opening at the base to evacuate the possible entry of water.
- Measures: Diameter 16 cm. Height 20 cm.

**HPLA8000**

||||| EAN 8436584381525

📦 12 UNITS

**HPLA5211**

||||| EAN 8436584382775

📦 12 UNITS



100/150  
20 X 16 cm  
GRAN RESISTENCIA  
MOSQUETÓN DE ALUMINIO  
FABRIADA EN POLYESTER



**Cremallera de cierre con compartimento para el tirador.**

**HPLA8020 / HPLA5212**

**Shoe wash bag FOR WASHING MACHINE**



- Extra protective anti-noise foam.
- Prevents friction and wear inside the washing machine.
- Suitable for all types of textile, leather, plastic, rubber, etc.
- Shoe protector during washing and drying, extending its life.
- Zipper with compartment for the handle, avoiding possible openings, noise and friction.
- High resistance padding.
- Measures: 36 x 16 x 16 cm.

**HPLA8020**

||||| EAN 8436584382096

📦 6 UNITS

**HPLA5212**

||||| EAN 8436584382782

📦 6 UNITS



GRAN RESISTENCIA  
ESPUMA ANTI RUIDO  
TODO TIPO DE TEJIDOS



**PT10**

**Protective ironing pad**



- Polyester bags, great resistance.
- Protects clothes when ironing.
- Avoid shiny marks.
- Washable.
- Measures: 60 x 39 cm.

**SURFACE  
60 x 39 cm**



LAVABLE  
GRAN RESISTENCIA  
PROTECTOR DE PRENDAS  
ELIMINA BRILLOS

||||| EAN 8436584380580

📦 12 UNITS

**HPLA5210**

**4 Mesh laundry bags FOR DELICATE CLOTHIN**



- Mesh laundry bags for washing delicate clothing.
- 4 bags, 3 different sizes.
- Zipper closure.
- Highly resistant polyester bags.
- Protects clothes during washing and drying.

**3 DIFFERENT SIZES**

- 2 small bags:**  
33 x 26 cm
- 1 medium bag:**  
44 x 34 cm
- large bag:**  
52 x 46 cm



GRAN RESISTENCIA  
1 BOLSA GRANDE 52 x 46 cm  
2 BOLSAS PEQUEÑAS 33 x 26 cm  
1 BOLSA MEDIANA 44 x 34 cm

||||| EAN 8436584382768

📦 12 UNITS

**HPLA8115**

**Iron and board caddy**

- Ironing board and steam iron organizer.
- Suitable for hanging on the wall / door.
- Elastic cord to fix the iron.
- Universal use.
- Hanging accessories included.
- Easy to install.
- Great resistance.



Elastic band



Door mount



Wall mount

||||| EAN 8436584382089

📦 6 UNITS

**HPLA8110**

**Silicone iron pad**

- Great resistance silicone.
- Universal use.
- Ironing board cover protection.
- Iron sole plate protection.
- Heat resistance.
- Antisliding.
- Hanging option.
- Measures: 27 x 14 cm



||||| EAN 8436584382072

📦 12 UNITS

**MOD 800**

**Easy iron accessory**

**NON-STICK**

- Accessory for ironing quickly and agilely, slides smoothly avoiding friction and shine on delicate fabrics.
- Adaptable to all plates.
- Designed to distribute steam evenly.
- Manufactured with non-stick material resistant to temperatures up to 250° C.



Size 23,5 x 14 cm / Thickness 0,55 mm.

||||| EAN 8436017650785

📦 24 UNITS



Video



**848S-01**

## Ladder / Ironing board

107 x 34 cm

- Easy change ladder / ironing board.
- 3 steps ladder, high stability. Height 70 cm.
- Ironing surface: 107 x 34 cm. Height ironing board: 85 cm.
- Stainless steel iron rest suitable for steam boilers.
- Iron rest with security rail of 32x21 cm.
- 100% cotton cover.
- 5 mm. felt underlay thickness.
- 1,2 mm. mesh thickness.
- Tube diameter 22 mm.
- According to the standard EN131-2

**COVER REPLACEMENT RF8N**  
92 x 35 cm

EAN 8436017653335

1 UNIT

22 UNITS PER PALLET

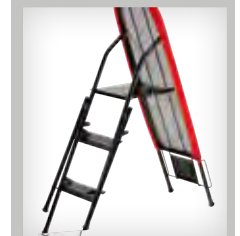

3 steps ladder,  
Height 70 cm



**HPLA8100**

## Ironing board

110 x 32 cm

- Ironing surface 110 x 32 cm.
- Structure with epoxy painting. Highly resistant to oxidation.
- 3 adjustable positions up to 92 cm.
- 100% cotton cover.
- Mesh thickness 0,8 mm.
- Tube diameter 19 mm.
- 3 mm. foam thickness.
- Non-slip feet.
- Iron rest. Measurements 30 x 20 cm.
- Measurements folded 150 x 40 x 7 cm.

*Premiere*



MADE IN EUROPE



100% cotton cover

**COVER REPLACEMENT RF50**  
116 x 35 cm

EAN 8436584381655

2 UNITS

48 UNITS PER PALLET



MADE IN EUROPE



**TP500**

## Ironing board

116 x 35 cm

- Ironing surface 116 x 35 cm.
- Thermo lacquered structure. Highly resistant to oxidation.
- Ergonomic platform made in mesh.
- Multi adjustable height positions up to 90 cm.
- Safety closing device.
- "Y" leg system that provides an optimum stability.
- 100% cotton bungee adjustable cover with integrated pad.
- Tube diameters 30 / 22 mm. Thickness 0,8 mm.
- Mesh thickness 0,9 mm.
- 4 mm felt pad thickness.
- Non-slip feet.
- Iron rest. Measurements 29 x 20 cm.

*Vital*



EAN 8436017659245

2 UNITS

36 UNITS PER PALLET



100% cotton bungee adjustable cover with integrated pad.

**TP520**

**Ironing board**

124 x 40 cm

*Compact*

- Ironing surface 124 x 40 cm.
- Thermo lacquered structure. Highly resistant to oxidation.
- Ergonomic platform in expanded metal.
- Multi adjustable height positions up to 93 cm.
- Safety closing device.
- "Y" leg system that provides an optimum stability.
- 100% cotton bungee adjustable cover with integrated pad.
- Tube diameters 30 / 22 mm. Thickness 0,8 mm.
- Mesh thickness 0,9 mm.
- 4 mm felt pad thickness.
- Non-slip feet.
- Iron rest suitable for steam stations. Measurements 44 x 27 cm.
- Hangers' hanging support.



MADE IN EUROPE

**COVER REPLACEMENT RF52**  
124 x 40 cm

EAN 8436017659252

2 UNITS

24 UNITS PER PALLET



124 x 40 cm



FUNDA 100% ALGODON



COVER WITH ELASTIC RUBBER ADJUSTMENT SYSTEM



100% cotton bungee adjustable cover with integrated pad.



MADE IN EUROPE

**TP550**

**Ironing board**

130 x 47 cm

*Suprema*

- Ironing surface 130 x 47 cm.
- Thermo lacquered structure. Highly resistant to oxidation.
- Ergonomic platform in expanded metal.
- Multi adjustable height positions up to 95 cm.
- Safety closing device.
- "Y" leg system that provides a great stability.
- Wheels for easy movement.
- Adjustable support to ensure optimum stability.
- 100% cotton bungee adjustable cover with integrated pad.
- Reinforced tube. Tube diameter 35 mm. Thickness 1 mm.
- Mesh thickness 1 mm.
- 4 mm felt pad thickness.
- Non-slip feet.
- Iron rest suitable for steam stations. Measurements 44 x 27 cm.



**COVER REPLACEMENT RF55**  
130 x 42 cm



Wheels for easy movement



COVER WITH ELASTIC RUBBER ADJUSTMENT SYSTEM



130 x 47 cm



FUNDA 100% ALGODON

EAN 8436017659269

2 UNITS

24 UNITS PER PALLET



**AUTUMN NOVELTY**



MADE IN EUROPE



100% cotton bungee adjustable cover



Iron rest 45 x 27 cm



**HPLA8242**

**Ironing board**  
130 x 47 ALUMINIUM

*Perfect*

- Ironing surface 130 x 47 cm.
- Lightweight and resistant anodized aluminum structure.
- Multi adjustable height positions up to 96 cm.
- 100% cotton bungee adjustable cover with integrated pad. Adjustable
- Hangers' hanging support.
- "Y" leg system that provides an optimum stability.
- Mesh thickness 0,8 mm.
- Safety closing device.
- 2 wheels for easy transport and non-slip legs.
- **Iron rest suitable for steam stations. Measurements 45 x 27 cm.**
- Space saving thanks to folding armrest.
- Measurements folded 146 x 48 x 13 cm.
- Weight: 7,95 kg.



48 x 146 cm



FUNDA 100% ALGODON



ESTRUCTURA ALUMINIO LIGERA Y RESISTENTE

||||| EAN 8436584385325  
24 UNITS PER PALLET

1 UNIT

**AUTUMN NOVELTY**



MADE IN EUROPE



100% cotton bungee adjustable cover



Iron rest 43 x 26,4 cm.



**HPLA8241**

**Ironing board**  
125 x 41 WOOD

*Maxima*

- Ironing surface 125 x 41 cm.
- Wooden legs and aluminum.
- Multi adjustable height positions up to 90 cm.
- 100% cotton bungee adjustable cover with integrated pad. Adjustable
- Hangers' hanging support.
- "Y" leg system that provides an optimum stability.
- Mesh thickness 0,8 mm.
- Safety closing device.
- 2 wheels for easy transport and non-slip legs.
- **Iron rest suitable for steam stations. Measurements 43 x 26,4 cm.**
- Measurements folded 161 x 44,5 x 10 cm.
- Weight: 7,60 K



44,5 x 161 cm



FUNDA 100% ALGODON



PATAS DE MADERA Y ALUMINIO

||||| EAN 8436584385332  
24 UNITS PER PALLET

1 UNIT

**TP600**

**Ironing board**  
136 x 46 FOLDABLE

*XL Optima Pro*

- Aluminium structure with anti-corrosion treatment (cataphoresis).
- Foldable for easy storage.
- Ergonomic platform in expanded metal.
- Multi adjustable height positions up to 93 cm.
- High resistance, up to 40 kg.
- Safety closing device.
- "Y" leg system that provides a great stability.
- Wheels for easy movement.
- Adjustable support to ensure optimum stability.
- 100% cotton cover with integrated pad.
- Reinforced tube 50 x 25 mm. Thickness 12 mm.
- Mesh thickness 1 mm.
- Support for steam irons 38 x 34 cm.
- Removable iron rest.
- Non-slip feet.



COVER WITH ELASTIC RUBBER ADJUSTMENT SYSTEM

**COVER REPLACEMENT RF60**  
137 x 45 cm

||||| EAN 8436017659276    1 UNIT  
10 UNITS PER PALLET

137 x 45 cm    FUNDA 100% ALGODON    COMES IN UNIT BOX

Wheels for easy movement    Support for steam irons 38 x 34 cm



Hook to hang from hangers, closet rods, etc.

**HPLA8214 / HPLA5213**

**Ironing board**  
75 x 34 TABLETOP

- Ironing surface 75 x 34 cm.
- Thermo lacquered structure. Highly resistant to oxidation.
- 100% cotton cover with elastic fit.
- Hanger hook.
- Non-slip feet.



**HFUN 8014**  
Only replacement cover available WITH ELASTIC FIT

**HPLA8214**  
||||| EAN 8436584382904  
6 UNITS  
144 UNITS PER PALLET

**HPLA5213**  
||||| EAN 8436584382799  
6 UNITS  
144 UNITS PER PALLET

75 x 34 cm    FUNDA 100% ALGODON    GANCHO COLGADOR

**TM200**

**Sleeve board**  
FOLDABLE 50 x 10 cm

- Ironing surface 50 x 10 cm.
- Thermo lacquered structure. Highly resistant to oxidation.
- 100% cotton cover with pad.



Foldable for easy storage



||||| EAN 8436017659320    6 UNITS  
378 UNITS PER PALLET

ALSO AVAILABLE IN UNIT BOX  
CÓD: TM200R

MADE IN EUROPE

FUNDA 100% ALGODON

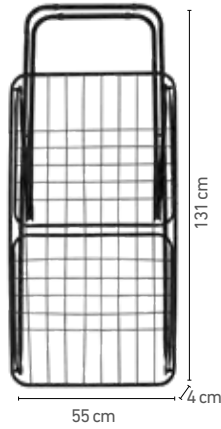

**HTEN2370**

**Folding clothing dryer rack WITH WINGS**

- Made of painted steel.
- Wing lock system.
- Laying area 20 m.
- Extended measurements: 180 x 55 x 108 cm
- Folded measurements: 131 x 55 x 4 cm
- Weight 2,1 kg.

**2,1 Kg**

**EXTENDED**  
180 x 55 x 108 cm

**FOLDED**  
131 x 55 x 4 cm

EAN 8436584384595 6 UNITS

54 UNITS PER PALLET

**HTEN2375**

**Folding aluminum clothing dryer WITH WINGS**

- Made of aluminum with steel legs.
- Wing lock system.
- 12 side clips for hanging hangers.
- Laying area 20 m.
- Extended measurements: 176 x 55 x 92 cm
- Folded measurements: 130 x 55 x 3.5 cm
- Weight 1,7 kg.

**1,7 Kg**

**EXTENDED**  
176 x 55 x 92 cm

**FOLDED**  
130 x 55 x 3,5 cm



COMES IN INDIVIDUAL CARTON BOX

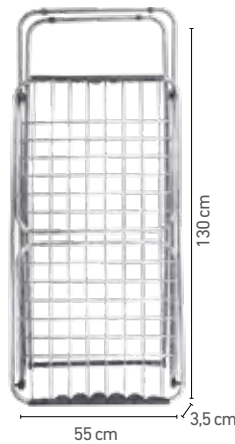
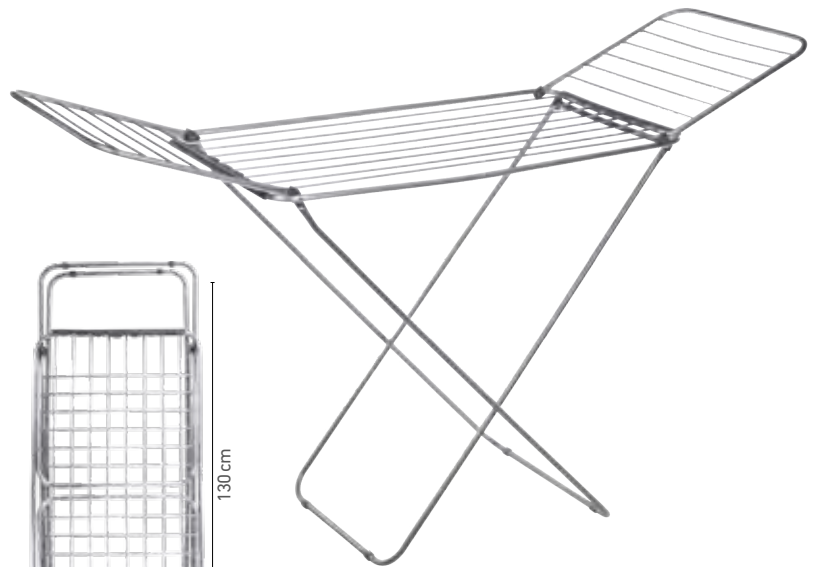

EAN 8436584384601 6 UNITS

54 UNITS PER PALLET



## Extendable clothesline

FROM 48 TO 96 cm

- Made of 304 stainless steel and polypropylene.
- Sock hanging clip.
- Laying surface 6 M.
- 20 clips included.
- Extendable from 48 to 96 cm
- Folded measurements: 58 x 32 x 4.7 cm
- Weight 0,6 kg.



AUTUMN NOVELTY

HTEN2402

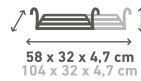
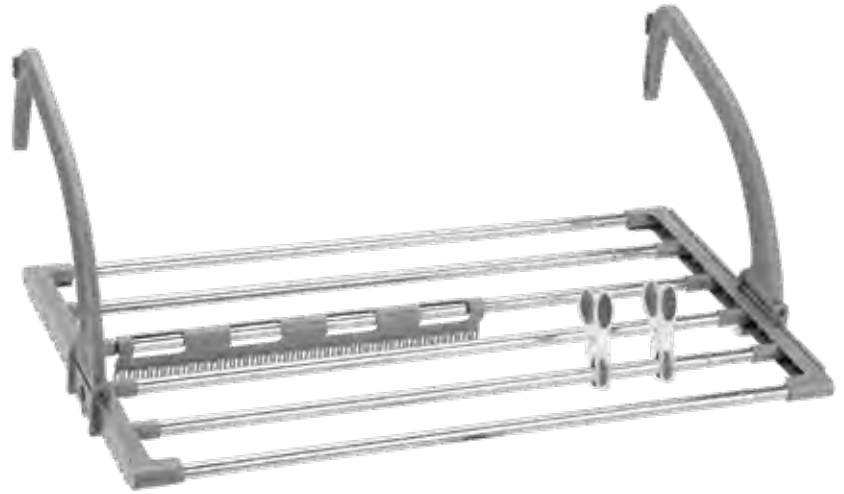

Sock hanging clip



Adjustable hangers

**HTEN2402**

EAN 8436584385110

6 UNITS

## Folding clothing dryer rack

- Made of painted steel.
- Laying area 3 m.
- Adjustable suspension.
- Size: 50 x 33 x 16 cm
- Weight 0,31 kg.



Adjustable suspension

AUTUMN NOVELTY

HTEN2403



**HTEN2403**

EAN 8421078038627

6 UNITS





QP398N - AZUL

JEQP5218 - GRIS

||||| EAN 8421078033011

||||| EAN 8421078036449

📦 12 UNITS

📦 12 UNITS



QP398N / JEQP5218

Lint shaver

- Easily removes fluff, lints and scrapes from textiles.
- Higher cut accessory.
- Anti-involuntary use security system.
- Stainless steel blades. Diameter 50 mm.
- Stainless steel grid.
- Compact and light design.
- On switch.
- Cleaning brush.
- Removable fluff container.
- Works with 2 "AA" batteries of 1,5 V (not included).

QP620

Lint shaver

- **Double use:** Adaptor / 2 batteries R20.
- Easily removes fluff, lints and scrapes from textiles.
- Anti-involuntary use security system.
- Stainless steel blades. Diameter 55 mm.
- Stainless steel grid.
- Compact and light design.
- On switch.
- Removable fluff container.
- Adaptor included, batteries not included.



||||| EAN 8421078030942

📦 12 UNITS



JEQP6688

Lint shaver

- Easily removes fluff, lints and scrapes from textiles.
- Stainless steel blades. Diameter 50 mm.
- Stainless steel grid.
- Built-in clothes brush with cover.
- On switch.
- Cleaning brush.
- Safety protection: Automatic stop when the blade lid is open.
- Removable fluff container.
- Works with 2 "AA" batteries of 1,5 V (not included).



||||| EAN 8421078038979

📦 12 UNITS

**AP998**

**Vacuum cleaner multi cyclone bag less**

**CLASS A 230 V - 700 W**

- Energy Efficiency (EU): A.
- Maximum suction, without air loss.
- Bag less.
- Tank capacity 3 liters.
- Multi-cyclone filter system.
- 3 levels double filter.
- Washable filters.
- Anti-mite filters, bacteria, pollen, etc.
- Airflow: 24,2 L/seg.
- Noise level <80 dB.
- Operation area 8 meters.
- Stainless steel telescopic tube.
- Brush for all kinds of floors.
- Crevice nozzle with integrated brush.
- Start button.
- Automatic winding cable.
- Carrying handle.



||||| EAN 8421078035589    1 UNIT



EFICIENCIA ENERGÉTICA  
**CLASE A**  
DOBLE FILTRO  
TRICAPA  
6 NIVELES DE FILTRADO



EFICIENCIA ENERGÉTICA  
**CLASE A**

**AP999**

**Vacuum cleaner multi cyclone bag less**

**CLASS A 230 V - 700 W**

- Energy Efficiency (EU): A.
- Maximum suction, without air loss.
- Bag less.
- Multi-cyclone filter system.
- Washable filters.
- Anti-mite filters, bacteria, pollen, etc.
- Airflow: 20,3 L/seg.
- Noise level <85 dB.
- Operation area 8 meters.
- Stainless steel telescopic tube.
- Brush for all kinds of floors.
- Crevice nozzle with integrated brush.
- Tank capacity 2 liters.
- Start button.
- Automatic winding cable.
- Carrying handle.



||||| EAN 8421078033158    1 UNIT

**AP915**

**Vacuum cleaner with bag**

**230 V - 800 W**

- No loss of suction.
- Washable filter: anti-mites, germ, pollen, etc.
- Air flow: 25 L/seg.
- Noise level: <80 dB.
- Operation area 7 meters.
- Stainless steel telescopic tube.
- Brush for all soil types.
- Nozzle with integrated brush.
- 2 bags included.
- Start button.
- Automatic cord rewind.
- Transport handle.

**Replacement bags**

**RBA915**

||||| EAN 8421078035183

30 UNITS



||||| EAN 8421078035169    1 UNIT



**SPRING NOVELTY**



Maximun efficiency with cyclonic tecnology



Integrated LED



Upholstery brush



**JEAP1950**

**Cordless broom vacuum cleaner**

230 V - 160 W

- Powerful motor with high performance and long life.
- Maximun efficiency with cyclonic tecnology.
- Easy cleaning due to integrated LED.
- Large tank (800 ml) with easy emptying system.
- Light and ergonomic.
- Triple filtering system: HEPA filters, stainless filter and outlet filter.
- **2 speed levels:**
  - TURBO: 11 Kpa / 25 min use.
  - ECO: 7 Kpa / 40 min use.
- Charging time: 4-5 hours.
- Detachable for easy cleaning.
- Rotary brush for increased performance. Suitable for all type of floors.
- Accesories included: charger, crevice nozzle, upholstery brush and wall mount.
- Very quiet, maximum 68 dB.
- Vacuum up to 40 minutes uninterruptedly without cord.
- HEPA filter that captures 99.9% of dust.

MOTOR DE ALTO RENDIMIENTO  
 LUZ LED INTEGRADA  
 TECNOLOGÍA CICLÓNICA  
 GRAN AUTONOMÍA  
 800 ml DEPÓSITO  
 160 W  
 SILENCIOSO  
 TRIPLE SISTEMA DE FILTRADO

EAN 8421078038597

1 UNIT

**AUTUMN NOVELTY**



Maximun efficiency with cyclonic tecnology



Integrated LED



Upholstery brush

**JEAP1629**



**BLDC Cordless broom vacuum cleaner**

230 V - 250 W

- Great power 250 W
- Powerful Brushless motor with high performance and long life.
- Maximun efficiency with cyclonic tecnology.
- Easy cleaning due to integrated LED.
- Large tank (800 ml) with easy emptying system.
- Light and ergonomic.
- Triple filtering system: HEPA filters, stainless filter and outlet filter.
- Charge percentage indicator.
- **3 speed levels:**
  - TURBO: 22 Kpa / 20 min use.
  - NORMAL: 12 Kpa / 35 min use.
  - ECO: 7 Kpa / 45 min use.
- Charging time: 4-5 hours.
- Detachable for easy cleaning.
- Rotary brush for increased performance. Suitable for all type of floors.
- Accesories included: charger, crevice nozzle, upholstery brush and wall mount.
- Maximum 76 dB.
- Vacuum up to 45 minutes uninterruptedly without cord.
- HEPA filter that captures 99.9% of dust.



MOTOR BLDC DE ALTO RENDIMIENTO  
 LUZ LED INTEGRADA  
 TECNOLOGÍA CICLÓNICA  
 GRAN AUTONOMÍA  
 800 ml DEPÓSITO  
 250 W  
 TRIPLE SISTEMA DE FILTRADO

**JEAP1629**

EAN 8421078038986

1 UNIT

**HU996****Ultrasonic air humidifier**

230 V - 25 W

- Humidifies and cleans the air of pollutant agents.
- Purifies the air with negative ions.
- Eliminates odors and avoids dry environment.
- Ultrasonic, cold steam.
- Effective range 30 m<sup>2</sup>.
- Steam outlet max 350 ml/h.
- 7 hours and 30 minutes timer.
- 3 levels steam outlet.
- Regulable steam outlet.
- Manual functioning and with remote control.
- Remote control works with 1 CR2025 battery (included).
- Automatic switch off.
- On indicator lights.
- Low water level pilot light.
- Quiet: 45 dB.
- Capacity 3 L.
- Water level indicator.
- Cleaning brush.
- Multi-current from 100-240 V.

EAN 8421078035770

4 UNITS

ULTRASONIDO  
VAPOR FRIO

45 dB

3 L  
CAPACIDAD

ION

ÁREA DE  
ACCIÓN  
30 M<sup>2</sup>

25 W

**HU992****Mini air humidifier**

100 - 240 V - 15 W

- Humidifies and cleans the air of pollutant agents.
- Eliminates odors and avoids dry environment.
- Ultrasonic, cold steam.
- Compact size.
- Effective range 20 m<sup>2</sup>.
- Steam outlet max 120 ml/h.
- 1 adaptor for plastic bottles included.
- 2 removable feet for an optimum stability.
- Automatic switch off.
- Indicator light.
- Steam regulator knob.
- Quiet.
- Cleaning brush.
- Multi-current adaptor from 100-240 V (included).

EAN 8421078032410

8 UNITS

ÁREA DE  
ACCIÓN  
20 M<sup>2</sup>

15 W

ULTRASONIDO  
VAPOR FRIO**JEHU5408****Essential oils diffuser**

- Neutralizes bad odours, avoids dry environments.
- Portable.
- It can be used as a night light thanks to its 7 colors.
- Color therapy.
- Timer for 1 hour, 3 hours and 6 hours.
- Silent.
- Perfect use as an air freshener.
- Level indicator.
- Safety auto power off.
- USB cable included.
- 300 ml. Capacity.
- Sizes: 17 x 21,4 cm

EAN 8421078037408

4 UNITS



7 Colors light

Size:  
17 x 21 cm

SILENCIOSO

TEMPORIZADOR  
1, 3, 6 h.0,3 L  
CAPACIDADLUZ NOCTURNA  
+ COLORTERAPIA**JEGA1001****Air purifier with UVC germicidal lamps**

CLEANS THE 99% OF THE AIR

- Compatible with people
- Mobile
- Easy placement
- Without maintenance
- Sustainable
- 100% national manufacturing
- UVC technology lamps, 100% safe for everyday use.
- Continuous air renewal while the room is in use.
- Product installation does not require professionals or maintenance.

EAN 8421078035817

1 UNIT

UV-C  
LAMPS

MÓVIL

TECNOLOGÍA  
UVC

SOSTENIBLE

RENOVACIÓN  
CONTINUAFÁCIL  
COLOCACIÓN

SEGURO



## JEHU2420



### AUTUMN NOVELTY



Water tank capacity: 5,5 l



Washable and easily removable air filter

#### JEHU2420

EAN 8421078039143

1 UNIT

## Dehumidifier 20 l

230 V - 440 W

- Extracts 20 L of moisture from the air per day.
- Water tank capacity: 5,5 l.
- 2 speed levels.
- Air flow: 180 m<sup>3</sup>/h.
- Max. sound level 42 dB.
- Selectable relative humidity: 30% - 80 %.
- Area of action: 20 - 35 15 m<sup>2</sup>
- Suction pressure 1.2 MPa
- Discharge pressure 2.5 MPa
- Fan, defrost and clothes drying function.
- Full tank warning function.
- Washable and easily removable air filter.
- Digital control panel. Option of manual or WIFI control with the TUYA SMART application.
- Cable storage system.
- Timer programmable up to 24 hours.
- Caster wheels.
- Transport handles.
- External drain connector included.
- Refrigerant R290 / 60 g.
- Measures: 35 x20 x 60 cm
- Weight: 13 kg.



## JEHU2413



### AUTUMN NOVELTY



External drain connector included

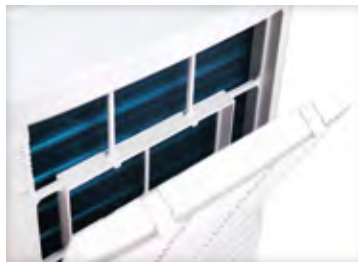

#### JEHU2413

EAN 8421078039402

1 UNIT

## Dehumidifier 12 l

230 V - 210 W

- Extracts 12 L of moisture from the air per day.
- Water tank capacity: 2 L.
- 2 speed levels.
- Air flow: 90 m<sup>3</sup>/h.
- Max. sound level 42 dB.
- Selectable relative humidity: 40% - 80 %.
- Area of action: 15 m<sup>2</sup>
- Suction pressure 0,6 MPa
- Discharge pressure 1,80 MPa
- Defrost function.
- Full tank warning function.
- Timer programmable up to 24 hours.
- Caster wheels.
- Transport handles.
- External drain connector included.
- Refrigerant R290/45 g.
- Measures: 27 x 20,5 x 40,8 cm
- Weight: 10,5 kg.





**KITCHEN**





**JEEX1046**

**Inox citrus juicer**

230 V - 350 W

- Stainless steel body and pouring lip.
- High performance AC motor.
- High speed in the extraction of juice.
- Unlimited extraction.
- Anti-drip system.
- Filter with pulp regulator.
- **Two cones to get the maximum efficiency.**
  - Big cone: oranges, grapefruits, etc.
  - Small cone: lemons, mandarins, etc. Detachable for easy cleaning.
- Anti-sliding base.
- Transparent cover.



||||| EAN 8421078036227

📦 6 UNITS

**EX1057**



**BLACK STAINLESS STEEL SERIES**



**Inox citrus juicer with handle**

230 V - 300 W

- Great power 300 W.
- Body, filter and pouring lip in stainless steel.
- Professional AC motor.
- Maximum efficiency.
- Handle for an easy extraction of juice.
- Unlimited extraction.
- Quiet.
- Anti-drip system.
- Juicing cone.
- Anti-sliding base.
- Detachable for easy cleaning.

**BLACK STAINLESS STEEL**

**AC MOTOR**  
ALTO RENDIMENTO

**SILENCIOSO**

**EX1057**

||||| EAN 8421078035398

📦 4 UNITS

**JEEX1058**

**Citrus juicer with handle**

230 V - 350 W

- Handle for an easy extraction of juice.
- Professional AC motor of 350 w power.
- Unlimited extraction.
- **Two cones to get the maximum efficiency.**
  - Big cone: oranges, grapefruits, etc.
  - Small cone: lemons, mandarins, etc.
- Detachable for easy cleaning.
- High speed in the extraction of juice.
- Anti-drip cover.
- Anti-sliding base.
- Removing juicer for easy cleaning.
- Pulp regulator.



||||| EAN 8421078036364

📦 6 UNITS



**JEEX1155**

**Inox citrus juicer with handle**

230 V - 600 W

- Great power 600 W.
- Professional AC motor.
- Body, filter and pouring lip in stainless steel.
- Maximum efficiency.
- Anti-drip system.
- Pressure lever to facilitate juice extraction.
- Quiet.
- Unlimited extraction.
- Includes two cones of different sizes to squeeze all kinds of citrus.
- Anti-sliding base.
- Detachable for easy cleaning.



||||| EAN 8421078038177

📦 4 UNITS

**JEEX1045**

**Inox citrus juicer with handle**

230 V - 600 W

- Body, filter and pouring lip in stainless steel.
- Professional AC motor.
- Maximum efficiency.
- Handle for an easy extraction of juice.
- Unlimited extraction.
- Quiet.
- Anti-drip system.
- **Two cones to get the maximum efficiency.**
  - Big cone: oranges, grapefruits, etc.
  - Small cone: lemons, mandarins, etc.
- Anti-sliding base.
- Detachable for easy cleaning.



||||| EAN 8421078036036

📦 4 UNITS







**EX1054**

**Inox citrus juicer with handle**

230 V - 600W

- Body, filter and pouring lip in stainless steel.
- Professional AC motor.
- Maximum efficiency.
- Handle for an easy extraction of juice.
- Unlimited extraction.
- Anti-drip system.
- **Two cones to get the maximum efficiency.**
  - Big cone: oranges, grapefruits, etc.
  - Small cone: lemons, mandarins, etc.
- Anti-sliding base.
- Detachable for easy cleaning.



ALTO RENDIMIENTO

||||| EAN 8421078035084

📦 4 UNITS

**JEEX1059**



**Citrus juicer with handle**

230 V - 160W

- Continuous extraction and pouring system.
- Stainless steel filter.
- Automatic start by pressing the cone.
- High performance AC motor. Maximum efficiency.
- Extraction arm to facilitate juice extraction.
- 300 ml removable container.
- Quiet.
- Anti-drip system.
- **Double cone:**
  - Big cone: oranges, grapefruits, etc.
  - Small cone: lemons, mandarins, etc.
- Anti-sliding base.
- Detachable for easy cleaning.



**JEEX1059**

||||| EAN 8421078036944

📦 4 UNITS



## Electric juicer

230 V - 60 W

- 1.2 l removable jug
- Dual direction rotation.
- Anti-sliding base.
- Protective cover
- **Two cones to get the maximum efficiency.**
  - Big cone: oranges, grapefruits, etc.
  - Small cone: lemons, mandarins, etc.



**JEEX1422**



**JEEX1422**

||||| EAN 8421078037132

8 UNITS



## EX421

### Inox citrus juicer

230 V - 40 W

- Capacity 700 ml.
- Dual direction rotation.
- **Two cones to get the maximum efficiency.**
  - Big cone: oranges, grapefruits, etc.
  - Small cone: lemons, mandarins, etc.
- Stainless steel body.
- Tank with handle.
- Detachable for easy cleaning.
- Transparent cover.
- Anti-sliding base.



||||| EAN 8421078034650

8 UNITS



## EX296

### Citrus juicer

230 V - 40 W

- Capacity 800 ml.
- Dual direction rotation.
- Tank with handle.
- Detachable for easy cleaning.
- Transparent cover.
- Anti-sliding base.



||||| EAN 8421078032564

8 UNITS





**JEEX1423**

**Electric juicer**

230 V - 40W

- Capacity 700 ml.
- Dual direction rotation.
- Tank with handle.
- Protective cover
- Detachable for easy cleaning.
- Anti-sliding base.
- **Two cones to get the maximum efficiency.**
  - Big cone: oranges, grapefruits, etc.
  - Small cone: lemons, mandarins, etc.



||||| EAN 8421078038191

8 UNITS

**JEEX1712**

SPRING NOVELTY



**Citrus juicer with handle**

230 V - 120 W

- Maximum efficiency.
- Anti-drip system.
- Pressure lever to facilitate juice extraction.
- Unlimited extraction.
- **Includes two cones of different sizes to squeeze all kinds of citrus.**
- Anti-sliding base.
- Cord storage.
- BPA free.
- Detachable for easy cleaning.



**JEEX1712**

||||| EAN 8421078038542

6 UNITS







## Electric juicer

230 V - 60 W

- Professional AC motor.
- Stainless steel pouring lip.
- Dual direction rotation.
- **Two cones to get the maximum efficiency:**
  - Big cone: oranges, grapefruits, etc.
  - Small cone: lemons, mandarins, etc.
- High speed in the extraction of juice.
- Unlimited extraction.
- Anti-drip system.
- Detachable for easy cleaning.
- Transparent cover.
- Cord storage.

JEEX1549

||||| EAN 8421078038801

📦 6 UNITS





**JELI1201**



**Slow extraction blender for fruits and vegetables**

230 V - 130 W

- New technology by endless pressure.
- Slow extraction: liquefy and squeeze with less revolutions (60 rpm).
- More flavour, retain all the vitamins and antioxidants.
- Suitable for extracting juice from fruits and vegetables.
- Continuous blending.
- Silent.
- 3 position switch: Off / On / Reverse (anti-jam function).
- Stainless steel filter.
- Compact design for easy storing.
- Jug included 600 ml.
- Pulp container 800 ml
- Detachable for easy cleaning. Brush included.
- Security lock.
- Homologated safety system.
- Anti-sliding base.



► ( ◀ **DISEÑO SLIM DE FÁCIL ALMACENAJE**

**+ MORE TASTE**  
KEEPING ALL THE VITAMINS Y ANTIOXIDANTS

**JELI1201**

||||| EAN 8421078036357

📦 4 UNITS



**JELI1580**



**Wide feeder stainless juice extractor**

230 V - 400 W

- 100% stainless steel body.
- Continuous extraction.
- 7 cm feeding tube: no need to cut fruits and vegetables.
- Stainless steel filter.
- 2 optional speed levels + Pulse
- 13.000 rpm.
- Maximum efficiency.
- 1,500 ml Pulp container
- 450 ml cup included.
- Drip-free
- Metallic security lock.
- Detachable for easy cleaning.
- Anti-sliding base.
- Noise level <75 dB.
- Homologated safety system.



**JELI1580**

||||| EAN 8421078037538

📦 4 UNITS



**TT579**

**Toaster**

230 V - Máx. 900 W

- Cold touch body.
- Wide slot to toast all type of bread. Wide 40 mm.
- Automatic bread centering.
- Electronic browning control. 6 positions.
- Defrost function.
- Re-heat function.
- Cancel button for stop toasting cycle.
- Crumb tray.
- Indicator lights.
- Cord storage.



**SIZE L x W x H**  
38 x 12 x 17,5 cm



||||| EAN 8421078034476

📦 4 UNITS



**TT632**

**Glass window toaster**

230 V - 900 W

- **Removable glass window:**
  - Double glass "Temperit", great protection.
  - Visible toaster.
  - Easy cleaning.
- Wide slot to toast all type of bread. Wide 38 mm.
- Automatic bread centering.
- Electronic browning control. 7 positions.
- Defrost function.
- Re-heat function.
- Cancel button for stop toasting cycle.
- Crumb tray.
- Indicator lights.
- Cord storage.

**SIZE L x W x H**  
41,5 x 15,5 x 20 cm



||||| EAN 8421078035442

📦 2 UNITS

**JETT1579**

**Toaster**

230 V - 900 W

- Cold touch body.
- Indicator lights.
- Cancel button for stop toasting cycle.
- Crumb tray.
- Automatic bread centering.
- Electronic browning control. 6 positions.
- Wide slot to toast all type of bread. Wide 40 mm..
- Defrost function.
- Re-heat function.
- Cord storage.



**SIZE L x W x H**  
38,5 x 12 x 17,5 cm



||||| EAN 8421078037927

📦 4 UNITS

**TT631 / TT331**



**Toaster**

230 V - 750 W

- Cold touch body.
- "High lift" system of special extra height for the extraction of small pieces of toast.
- Two extra wide slots. "Wide bread".
- Central bread guide.
- 6 browning positions.
- Cancel function.
- Protective lid.
- Crumb tray.
- Cord storage.



**TT631**  
 ■■■■ EAN 8421078035039  
 ■ 8 UNITS

**TT331**  
 ■■■■ EAN 8421078029397  
 ■ 8 UNITS

**SIZE L x W x H**  
**25,5 x 15 x 17,5 cm**



**JETT1048**



**2 slot toaster**

230 V - 750 W

- Two 13,3 x 3,3 cm slots.
- Central bread guide.
- Electronic power selector with 6 toasting levels.
- Cold touch body.
- Cancel function.
- Protective dust cap.
- Easy cleaning: removable crumb tray.
- Automatic shut-off.
- Cord length: 95 cm.
- Cord storage.



**DOS RANURAS ANCHAS**

**SIZE L x W x H**  
**26 x 12 x 17,5 cm**

**JETT1048**  
 ■■■■ EAN 8421078038894  
 ■ 6 UNITS





**JETT1262**

## 2 slot toaster

230 V - 750 W

- 2 slots 13 x 2,8 cm.
- Cold touch body.
- Non-slip feet
- Central bread guide.
- Electronic power selector with 7 toasting levels.
- Cancel function.
- Defrost function.
- Protective dust cap.
- Removable crumb tray.
- Automatic shut-off.
- Re-heat function.
- LED indicator light.
- Cord storage.



SIZE L x W x H  
**37 x 17 x 19 cm**

**JETT1262**

||||| EAN 8421078038900

📦 6 UNITS



DOS RANURAS  
**ANCHAS**

**JETT1585**

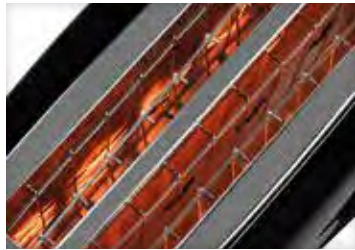

**Long double slot toaster**

230 V - 1.400 W

- Cold touch body.
- Non-slip feet
- Automatic bread centering.
- 7 browning levels.
- Two 25 x 3 cm slots.
- Defrost and keep warm functions.
- Voluntary stop button and automatic disconnection.
- Crumb tray.
- LED indicator light.
- Cord storage.



**RANURAS LARGAS**  
25 x 3 cm

**SIZE L x W x H**  
**38,5 x 14,5 x 17 cm**

**JETT1585**

||||| EAN 8421078038207

📦 4 UNITS

**JETT1584**

**SPRING NOVELTY**

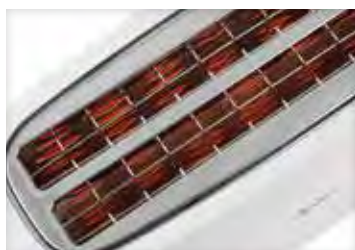

**JETT1584**

**Long double slot toaster**

230 V - 1.400 W

- Cold touch body.
- Non-slip feet
- Automatic bread centering.
- 7 browning levels.
- Two 25 x 3 cm slots.
- Defrost and keep warm functions.
- Voluntary stop button and automatic disconnection.
- Crumb tray.
- LED indicator light.
- Cord storage.

**SIZE L x W x H**  
**38 x 15 x 17,5 cm**



**RANURAS LARGAS**  
25 x 3 cm

**JETT1584**

||||| EAN 8421078038696

📦 4 UNITS



**TT1046**

**PRO SERIES**

### Inox toaster

230 V - Máx. 1.400 W

- Stainless steel body.
- Two slots with a length of 255 mm. Wide 40 mm.
- Automatic bread centering.
- Electronic browning control. 5 positions.
- Defrost function.
- Re-heat function.
- Cancel button for stop toasting cycle.
- Crumb tray.
- Indicator lights.
- Cord storage.

**SIZE L x W x H**  
40 x 16,5 x 18,5 cm



**TT1043**

**PRO SERIES**

### Inox toaster

230 V - Máx. 1.000 W

- Stainless steel body.
- Wide slot to toast all type of bread. Wide 40 mm.
- Automatic bread centering.
- Electronic browning control. 5 positions.
- Defrost function.
- Re-heat function.
- Cancel button for stop toasting cycle.
- Crumb tray.
- Indicator lights.
- Cord storage.

**SIZE L x W x H**  
40 x 12 x 18,5 cm



||||| EAN 8421078033936

4 UNITS

||||| EAN 8421078033929

4 UNITS

**JETT1588**

### Flat toaster

230 V - 600 W

- Timer: 5 minutes.
- Stainless steel body and grill.
- Homogeneous toasting. 3 quartz tubes.
- On / off switch.
- Removable crumb tray.
- Taste and smell of freshly baked bread.



**SIZE L x W x H**  
38 x 22,5 x 7 cm



||||| EAN 8421078038436

6 UNITS



**JETT1587 / TT587**



SIZE L x W x H  
33,5 x 21,5 x 6 cm



**Flat toaster**

230 V - 400 W

- Stainless steel laterals.
- Taste and smell of freshly baked bread.
- Great toasting surface.
- On / off switch.
- 2 quartz tubes.
- Removable crumb tray.



**JETT1587 - BLACK**

||||| EAN 8421078037996

📦 6 UNITS



**TT587 - WHITE**

||||| EAN 8421078032540

📦 6 UNITS



**TT589**



**TT589NG**

SIZE L x W x H  
33,5 x 21,5 x 6 cm



**TT589 - TT589NG**

**Flat toaster**

230 V - 550 W

- Stainless steel body and grill.
- Homogeneous toasting. 4 quartz tubes.
- Great toasting surface.
- Protective lid.
- On / off switch.
- Removable crumb tray.
- Taste and smell of freshly baked bread.



**PROTECTIVE DUST COVER**

**TT589 - WHITE**

||||| EAN 8421078305897

📦 6 UNITS

**TT589NG - BLACK**

||||| EAN 8421078034001

📦 6 UNITS

**JETT0201**

**Flat toaster "Mini"**

230 V - 300 W

- Compact size and easy to store.
- Stainless steel body and grill.
- 2 quartz tubes.
- Removable crumb tray.

*Compact size*

SIZE L x W x H  
28 x 17 x 6 cm



||||| EAN 8421078035985

📦 6 UNITS



**TT588**

**Flat toaster**

230 V - 600 W

- Timer: 5 minutes.
- Stainless steel body and grill.
- Homogeneous toasting. 3 quartz tubes.
- On / off switch.
- Removable crumb tray.
- Taste and smell of freshly baked bread.

SIZE L x W x H  
36,5 x 22,5 x 6,5 cm



||||| EAN 8421078031932

📦 6 UNITS

**TT591 / TT5016**

**Flat toaster**

230 V - 1.000 W

- Great toasting surface. Measures 35 x 25 cm.
- Homogeneous toasting. 5 quartz tubes.
- Stainless steel body and grill.
- 2 switches, 3 heating powers: 400 W - 600 W - 1.000 W.
- Removable crumb tray.
- Taste and smell of freshly baked bread.

**EXTRABIG**  
*Toasts*

ÚNICA **5** BARRAS DE CUARZO

TT591 - BLACK

||||| EAN 8421078035350

📦 4 UNITS

TT5016 - WHITE

||||| EAN 8421078035794

📦 4 UNITS



TT591



TT5016

SIZE L x W x H  
45 x 26 x 6 cm



**JECA1287**



# Coffee maker

230 V - 600 W

- Drip coffee maker from 2 to 8 cups.
- Suspended filter holder with handle.
- Permanent filter.
- Anti-drip system.
- Measuring spoon.
- Non-stick heating plate.
- Glass jar with lid.
- Translucent and graduated water tank.
- On / off switch light.
- In compliance with ERP saving energy standard.
- Auto-shut off.



**JECA1287**

||||| EAN 8421078038078

📦 6 UNITS



**CA288N**

# Coffee maker

230 V - 550 W

- Drip coffee maker from 2 to 8 cups.
- In compliance with ERP saving energy standard.
- Auto-shut off.
- Swing-out filter.
- Permanent filter.
- Anti-drip system.
- Non-stick heating plate.
- Translucent and graduated water tank.
- Glass jar with lid.
- On / off switch light.



**CA288N**

||||| EAN 8421078026006

📦 6 UNITS





CA290



## Coffee maker

230 V - 680 W

- Drip coffee maker from 2 to 12 cups.
- In compliance with ERP saving energy standard.
- Auto-shut off.
- Swing-out filter.
- Permanent filter.
- Anti-drip system.
- Non-stick heating plate.
- Graduated water tank.
- Glass jar with lid.
- On / off switch light.

CA290

||||| EAN 8421078032403

6 UNITS



**JECA1750 / JECA1752**

**SPRING NOVELTY**



**JECA1750 - BLACK**

||||| EAN 8421078038658

📦 6 UNITS



**JECA1752 - WHITE**

||||| EAN 8421078038672

📦 6 UNITS

## Coffee maker

230 V - 650 W

- Drip coffee maker from 2 to 8 cups.
- Removable filter holder.
- Anti-drip system.
- Measuring spoon.
- Non-stick heating plate.
- 750 ml glass jug with lid.
- Translucent and graduated water tank.
- On / off switch light.
- Front button for automatic on and off.
- In compliance with ERP saving energy standard.
- Auto-shut off.
- Non-slip base.





**AUTUMN NOVELTY**

**JECA1800**

## Coffee maker WITH THERMO JUG

230 V - 650 W

- Drip coffee maker from 2 to 12 cups.
- Double-walled thermal jug.
- Maintains the temperature for 6 to 12 hours.
- 1 l Capacity
- Suspended filter holder with handle.
- Jug with anti-drip system.
- Removable and washable permanent filter.
- Non-stick heating plate.
- Anti-sliding base.
- Measuring spoon.
- Graduated water tank.
- On / off switch light.
- Auto-shut off.
- In compliance with ERP saving energy standard.



**JECA1800**

EAN 8421078038870

6 UNITS



JARRA TERMO

1L CAPACIDAD

x12

FILTRO PERMANENTE

800 W

ERP CUMPLE NORMATIVA



**JECA2300**



## Espresso coffee maker

230 V - 1.360 W

- Pressure 20 bar.
- **Touch screen:**
  - On / Off
  - 1 cup pusher.
  - 2 cups pusher.
  - Steamer.
- **Accessories included:**
  - Filter holder.
  - Filter to make 1 - 2 espresso coffee cups.
  - Dispenser.
- In compliance with ERP saving energy standard.
- Memorize the quantity of coffee.
- Automatic switch off.
- Steam regulator.
- Surface to keep cups warm.
- Removable drop-collector for easy cleaning.
- Removable water tank. 0,9 l capacity.



**JECA2300**

||||| EAN 8421078038092

☐ 2 UNITS



## Coffee maker

230 V - 800 W

- Drip coffee maker from 6 to 18 cups.
- Capacity 1,5 l
- Permanent filter.
- Measuring spoon.
- Non-stick heating plate.
- Anti-drip system.
- Glass jar with lid.
- Graduated water tank.
- On / off switch light.
- In compliance with ERP saving energy standard.
- Auto-shut off.



**JECA1512**

||||| EAN 8421078038863

📦 6 UNITS



## Coffee grinder 55 gr

230 V - 150 W

- Lid with safety lock system.
- Stainless steel container.
- Stainless steel blade.
- Grinding view.
- Switch on pusher.
- Capacity 65 g.



**JEML1150**

||||| EAN 8421078039112

📦 6 UNITS





**ML132**

**Coffee grinder 65 gr**

230 V - 160 W

- Lid with safety lock system.
- Stainless steel container.
- Stainless steel blade.
- Grinding view.
- Switch on pusher.
- Capacity 65 g.



||||| EAN 8421078033806

📦 6 UNITS

**ML133**

**Coffee grinder 55 gr**

230 V - 160 W

- Stainless steel body.
- Lid with safety lock system.
- Stainless steel container.
- Stainless steel blade.
- Grinding view.
- Switch on pusher.
- Capacity 55 g.



||||| EAN 8421078033530

📦 6 UNITS



**JEES1111**

**Milk frother and mini cappuccino mixer**

- It can be used in hot or cold milk.
- 6-8 seconds to foam.
- 12 seconds for cappuccino.
- Stainless steel rod.
- Silent engine.
- Storage stand included.
- Ergonomic.



8 UNITS DISPLAY BOX  
29,5 x 15,5 x 27,5 cm



||||| EAN 8421078038320

📦 8 UNITS



**JECL1900**

**Milk frother 150 ml  
and Warmer 300 ml**

230 V - 550 W

- On switch.
- Capacity 150 ml. to froth and 300 ml to heat milk.
- Operation indicator light.
- Easy to clean nonstick jug.
- Internal volume indicator min and max.
- 3 functions: frothing hot or cold milk, heating milk and heating chocolates.
- Auto shut off.
- Overheating safety device.
- Maximum heating temperature 65°
- 360° swivel base.



||||| EAN 8421078038146

📦 6 UNITS



**JECL1820**

**Milk warmer 240 ml**

230 V - 400 W

- Capacity 240 ml
- Hidden heating element. Easy cleaning.
- Internal level indicator min and max.
- Anti-scald handle and body
- Keep the milk temperature around 65 °C (± 5°C)
- On switch.
- On indicator light.
- Auto shut off.
- Overheating safety device.
- Cordless use of the jug.
- Cord storage.
- Stainless steel heating plate.
- 360° swivel base.



||||| EAN 8421078038085

📦 6 UNITS

**CL819**

**Milk warmer 1l**

230 V - 400 W

- Ideal to heat milk and prepare chocolate.
- Inner non-stick coating free of PFOA.
- Cold touch body.
- Keep the milk temperature around 80 °C.
- Capacity 1 l.
- Hidden heating element. Easy cleaning.
- Overheating safety device.
- On / off switch.
- On indicator light.



||||| EAN 8421078033776

📦 4 UNITS





**JEHA1723**

**Stainless steel kettle 2l**

230 V - 1.500 W

2l

- Stainless steel body.
- 2 l Capacity
- High speed boiling.
- Double security system.
- Cordless.
- Easy cleaning.
- Stainless steel heating plate.
- Hinged lid.
- Auto shut off.
- Overheating safety device.
- Water level indicator.
- On / off switch light.
- 360° swivel base.
- Cord storage.



||||| EAN 8421078038023

📦 6 UNITS

**JEHA1575**



**Electric kettle 1,7 l**

1,7l

230 V - 1.500 W

- Capacity 1,7 l.
- Maximum boiling capacity.
- Cordless.
- LED temperature indicator display.
- Hidden heating element. Easy cleaning.
- Large filling mouth with lid.
- Stainless steel heating plate.
- **5 temperature levels: 45 / 50 / 70 / 85 / 100 °C**
- Double layer thermal insulation.
- Ergonomic cold touch handle.
- Re-heat function.
- Auto shut off.
- Overheating safety device.
- BPA free.
- 360° swivel base.



**JEHA1575**

||||| EAN 8421078038849

📦 6 UNITS

**JEHA1809**

**Electric kettle 1,7l**

230 V - Máx. 2.200 W

1,7l



- Maximum boiling capacity.
- 1,7 L Capacity
- Cordless jug
- Water level indicator
- Hidden heating element. Easy cleaning.
- Tip up lid.
- Removable anti-calc filter
- Stainless steel heating plate.
- On / off switch light.
- Auto shut off.
- Overheating safety device.
- 360° swivel base.
- Cord storage.
- BPA free.



||||| EAN 8421078038832    6 UNITS

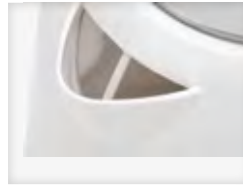

**HA702**

**Glass kettle 1,2l**

230 V - Máx. 1.500 W

1,2l

- **Borosilicate jar:**
  - Exempt from heavy metals and toxic substances.
  - Crystal of the best quality, non-porous, neutral (no smell or taste).
  - Maximum chemical and mechanical resistance.
  - Free of BPA.
- Capacity 1,2 l.
- Maximum boiling capacity.
- Hidden heating element. Easy cleaning.
- Stainless steel heating plate.
- Lid.
- Auto shut off.
- Overheating safety device.
- On switch.
- Cordless.
- 360° swivel base.
- Cord storage.



||||| EAN 8421078033912    6 UNITS

**HA701**

**Kettle 1l**

230 V - 2.200 W

1l

- Capacity 1 l.
- Maximum boiling capacity.
- Cordless.
- Hidden heating element. Easy cleaning.
- Stainless steel heating plate.
- Tip up lid.
- Auto shut off.
- Overheating safety device.
- Water level indicator.
- Removable filter.
- On / off switch.
- 360° swivel base.
- Cord storage.



||||| EAN 8421078032977    6 UNITS





**JEHA1038**



**RED  
SERIES**



**Kettle 1l**

230 V - 2.200 W

**1l**

- Capacity 1 l.
- Maximum boiling capacity.
- Hidden heating element. Easy cleaning.
- Stainless steel heating plate.
- Internal water volume indicator.
- Tip up lid.
- Auto shut off.
- Overheating safety device.
- Heat insulating plastic handle
- On switch.
- 360° swivel base.
- Cord storage.

**JEHA1038**

||||| EAN 8421078037194

📦 6 UNITS

MÁXIMA  
RAPIDEZ DE  
EBULLICIÓN

⚡  
2200 W

PLACA  
INOX

LIBRE DE  
BPA

JARRA  
SIN CABLE

**JEHA1808**

**AUTUMN  
NOVELTY**



**Electric kettle 0,8l**

230 V - 1.000 W

**0,8l**

- Capacity 0,8 l.
- BPA free.
- Maximum boiling capacity.
- Cordless.
- Anti calc filter.
- Hidden heating element.
- 304 Stainless steel heating plate.
- ON / OFF switch.
- Luminous operating display.
- Special wide mouth for easy cleaning.
- Auto shut off.
- Overheating safety device.
- 360° swivel base.
- Cord storage.



**JEHA1808**

||||| EAN 8421078039136

📦 6 UNITS

⚡  
1000 W

RAPIDEZ DE  
EBULLICIÓN

LIBRE DE  
BPA

# Electric kettle 0,5l 0,5l

230 V - 900 W

- Capacity 0,5 l.
- Compact design.
- Cold touch handle.
- BPA free.
- Maximum capacity of boiling.
- On / off switch.
- Hidden heating element. Easy cleaning.
- Stainless steel heating plate.
- Water level indicator.
- Tip up lid with safety lock.
- Auto shut off.
- Boil protection system.
- Cord storage.



**JEHA1240**

||||| EAN 8421078038825

8 UNITS

**AUTUMN NOVELTY**

**JEHA1240**



# HA547 Kettle 0,5l 0,5l

230 V - 1.000 W

- Capacity 0,5 l.
- Maximum capacity of boiling.
- Hidden heating element. Easy cleaning.
- Stainless steel heating plate.
- Tip up lid.
- Auto shut off.
- Overheating safety device.
- Water level indicator.
- On / off switch.
- Cord storage.



||||| EAN 8421078032014

6 UNITS

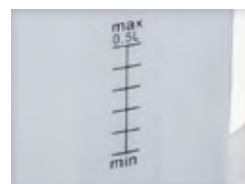

**GR3000**



# Excellence Electric grill

230 V - 2.700 W

- "Excellence" heating element. Perfect heat performance over all the surface.
- Electronic function control.
- 4 temperatures: 75 / 120 / 160 / 230 °C.
- Minimum temperature suitable for heating plates.
- Granite Black non-stick coating free of PFOA.
- Granite Black great hardness and excellent scratch resistance.
- "Super Diet" system: To slope the plate and make easier the sauce collecting.
- Measures 480 x 320 mm.
- Removable cable cord.
- Sauce tray.
- Cold touch handles.
- Table carrying.
- Easy cleaning.



**SURFACE**  
480 x 320 mm

**GR3000**

||||| EAN 8421078033813

📦 2 UNITS



DISEÑADO EN ESPAÑA



RESISTENCIA PATENTADA



SUPERFICIE GRANITE BLACK



**JEGR2851**

**Stonite electric grill**

230 V - 2.600 W

- Patented M-shaped heating element. Cooks in all the surface, ensuring perfect heat diffusion.
- Electronic temperature control: 75 / 120 / 160 / 230 °C.
- Minimum temperature suitable for heating plates.
- Stonite high quality PFOA-free non-stick coating.
- Super Diet system which helps fat and sauces collecting.
- Measures 460 x 280 mm.
- Removable cable cord.
- Cold touch handles.
- Easy cleaning.



**SURFACE**  
460 x 280 mm



EAN 8421078036388

2 UNITS

**SURFACE**  
460 x 280 mm



**GR2600**

**M-Magic electric grill**

230 V - 2.600 W

- Heating element in "M". Cooks in all the surface.
- Electronic function control.
- 4 temperatures: 75 / 120 / 160 / 230 °C.
- Minimum temperature suitable for heating plates.
- Measures 460 x 280 mm.
- Removable cable cord.
- Non-stick coating free of PFOA.
- "Super Diet" system: To slope the plate and make easier the sauce collecting.
- Sauce tray.
- Cold touch handles.
- Table carrying.
- Easy cleaning.



EAN 8421078035534

2 UNITS

**JT950**

**M-Magic electric grill**

230 V - 2.500 W

- "Granite" non-stick coating free of PFOA.
- "Granite" great hardness and excellent scratch resistance. Perfect heat performance.
- Heating element in "M". Cooks in all the surface.
- Sauce tray.
- Cold touch handles.
- Table carrying.
- Easy cleaning.
- Manufactured in Spain.
- "Super Diet" system: To slope the plate and make easier the sauce collecting.
- Measures 460 x 280 mm.
- Removable adjustable thermostat of temperature.
- Suitable for the dishwasher.

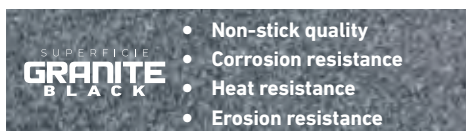

EAN 8421078033509

6 UNITS

**SURFACE**  
460 x 280 mm



**GR558**

**SURFACE**  
460 x 280 mm



**M-Magic electric grill**

230 V - 2.500 W

- "Granite" non-stick coating free of PFOA.
- "Granite" great hardness and excellent scratch resistance. Perfect heat performance.
- Heating element in "M". Cooks in all the surface.
- "Super Diet" system: To slope the plate and make easier the sauce collecting.
- Measures 460 x 280 mm.
- Removable adjustable thermostat of temperature.
- Sauce tray.
- Cold touch handles.
- Suitable for the dishwasher.
- Table carrying.
- Easy cleaning.
- Manufactured in Spain.



**GR558**

||||| EAN 8421078032649

6 UNITS



**GR557A**

**SURFACE**  
460 x 280 mm



**M-Magic electric grill**

230 V - 2.500 W

- "Stonite" non-stick coating PFOA free.
- Heating element in "M". Cooks in all the surface.
- "Super Diet" system:
- To slope the plate and make easier the sauce collecting.
- Measures 460 x 280 mm.
- Sauce tray.
- Cold touch handles.
- Removable adjustable thermostat of temperature.
- Suitable for the dishwasher.
- Table carrying.
- Easy cleaning.
- Manufactured in Spain.



**GR557A**

||||| EAN 8421078029991

6 UNITS





**GR555A**

**M-Magic electric grill**

230 V - 2.500 W

- Non-stick ceramic coating free of PFOA.
- Heating resistance in "M".
- "Super Diet" system.
- Sauce tray.
- Cold touch handles.
- Easy cleaning.
- Removable adjustable thermostat of temperature.



**SURFACE**  
460 x 280 mm

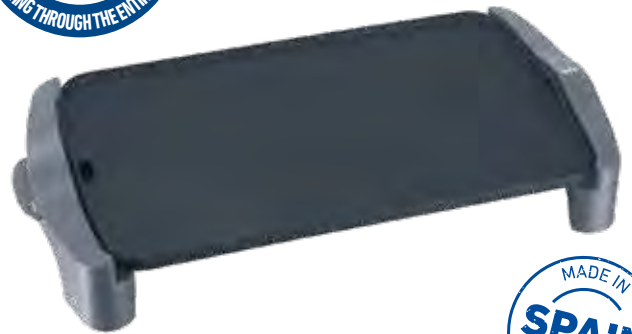

**GR555A**

||||| EAN 8421078026532

📦 6 UNITS



**GR669 - GR559**

**TERRACOTA Electric grill**

230 V - 1.600 W

- Terracotta fired at high temperature. Extreme hardness.
- Artisan manufacturing.
- Unaffected by use or by time.
- Cooks all kinds of fish and meat.
- The unique and natural taste.
- Surface 460 x 280 mm.
- Scratchproof. Surface knife proof cutting.
- Removable adjustable thermostat of temperature.
- Cold touch handles.
- Table carrying.
- Easy cleaning.
- Manufactured in Spain.



**SURFACE**  
460 x 280 mm



**GR669**



**GR669**

||||| EAN 8421078034285

📦 2 UNITS



**GR559**

||||| EAN 8421078030607

📦 2 UNITS



**VERSATILE DISPLAY**  
FOR ALL OUR  
**GRILLS AND BARBECUES**



**GR559**

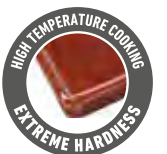



**JEGR0550**

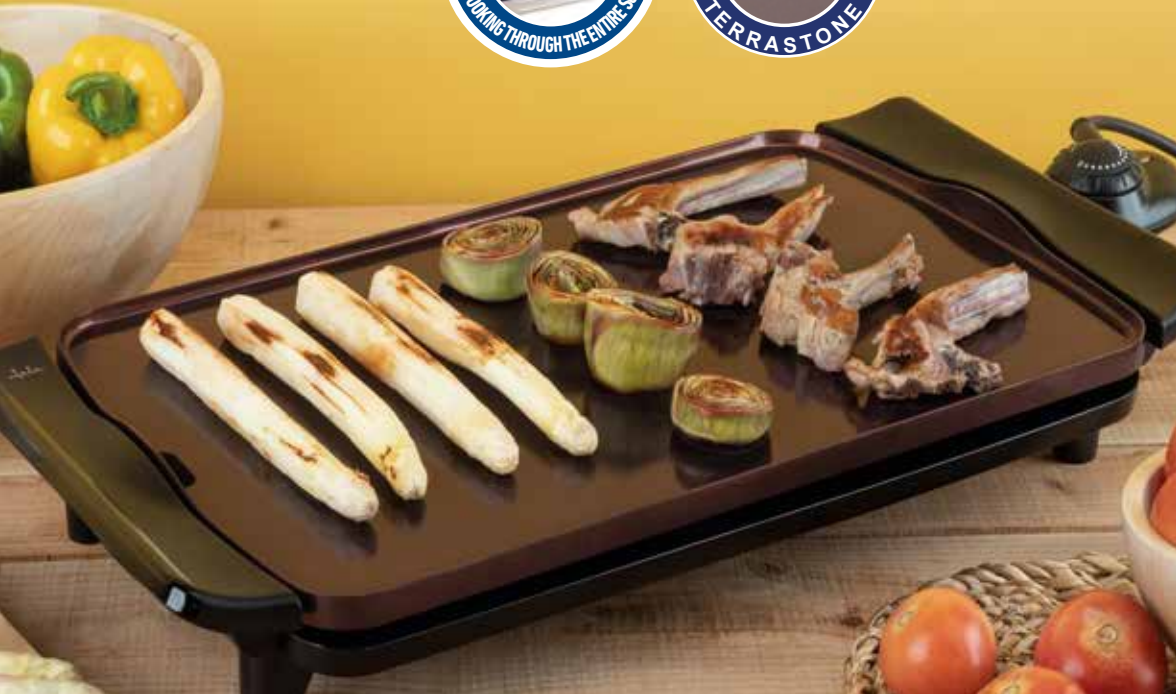

# Electric grill S E N S E S

230 V - 2.700 W

- Designed and manufactured in Spain.
- Patented "M-Magic" resistance.
- Heats and cooks evenly over the entire surface.
- High quality cast aluminum.
- Triple layer of super resistant Terrastone CopperMax non-stick coating.
- PFOA free.
- SuperDiet System; the surface slopes facilitating the collection of sauces and removal of excess fat.
- XL sauce collecting tray.
- Adjustable and removable temperature thermostat.
- Cool touch handles. Transportable to the table.
- Easy cleaning.
- Slim design for easy storage.
- Measures 460 x 280 mm.



**SURFACE**  
460 x 280 mm

**JEGR0550**

||||| EAN 8421078037293

4 UNITS

RECUBRIMIENTO  
**TERRASTONE**  
COPPERMAX



**GR195**

**Electric grill**

230 V - 2.200 W

- Non-stick coating free of PFOA. Whitford Xylan® Plus.
- High resistance against the scratches.
- Surface 460 x 250 mm.
- Removable adjustable thermostat of temperature.
- Cold touch handles.
- Table carrying.
- Sauce tray.
- Easy cleaning.



||||| EAN 8421078032656

📦 4 UNITS

**SURFACE**  
460 x 250 mm



**SURFACE**  
550 x 260 mm



**GR217**

**Electric grill**

230 V - Máx. 2.200 W

- Non-stick coating free of PFOA. Whitford Xylan® Plus.
- High resistance against the scratches.
- Surface 550 x 260 mm.
- Removable adjustable thermostat of temperature.
- Cold touch handles.
- Table carrying.
- Sauce tray.
- Easy cleaning.



||||| EAN 8421078034773

📦 4 UNITS

**JEGR1603**

**Electric grill XXL**

230 V - 2.400 W

- M-Magic patented resistance: Cook equally on the entire surface.
- Large surface of 60 x 35 cm.
- PFOA free non-stick coating.
- Cold touch handles.
- Table carrying.
- High resistance against the scratches.
- Sauce collecting tray.
- Adjustable and removable temperature thermostat.
- Easy cleaning.



||||| EAN 8421078038122

📦 2 UNITS

**SURFACE**  
600 x 350 mm



**JEGR1241**

**AUTUMN  
NOVELTY**



## Electric grill

230 V - 2.200 W

- Non-stick coating free of PFOA. Whitford Xylan® Plus.
- High resistance against the scratches.
- Surface 500 x 250 mm.
- Anti-fat system that captures excess fat or liquids.
- Removable adjustable thermostat of temperature.
- Cold touch handles.
- Table carrying.
- Sauce collecting tray.
- Easy cleaning.

**SURFACE**  
500 x 250 mm



**JEGR1241**

||||| EAN 8421078038931

📦 4 UNITS

**XL SUPERFICIE** 50 x 25 cm **RECUBRIMIENTO Xylan Plus** 2200 W Máx. **LIBRE DE PFOA**



**GR204N**

**Electric grill**

230 V - 2.000 W

- Non-stick coating free of PFOA. Daikin Silkware®.
- High resistance against the scratches.
- Measures 445 x 300 mm.
- Removable adjustable thermostat of temperature.
- Cold touch handles.
- Suitable for the dishwasher.
- Table carrying.
- Sauce tray.
- Easy cleaning.



||||| EAN 8421078030850

📦 4 UNITS

**SURFACE**  
445 x 300 cm



**Electric grill**

230 V - 1.000 W

- Smooth PFOA free "Durastone" non-stick coating.
- High resistance against the scratches.
- Surface 280 x 220 mm.
- Removable adjustable thermostat of temperature.
- Cold touch handles.
- Suitable for the dishwasher.
- Table carrying.
- Sauce tray.
- Easy cleaning.



**GR205 - BLACK**

||||| EAN 8421078029854

📦 6 UNITS



**JEGR5522 - ROSE**

||||| EAN 8421078037484

📦 6 UNITS

**GR205 / JEGR5522**



**SURFACE**  
280 x 220 cm



**SUPERFICIE DURASTONE**

**PE550**



# Electric paella pan

230 V - 1.900 W

- Diameter 55 cm. Special for large paellas, stews, etc.
- Uniform temperature throughout the surface.
- Non-stick coating free of PFOA.
- 2 switches, two powers.
- Metal and glass cover.
- Steam outlet valve.
- Removable cable cord.
- Cold touch handles.
- Table carrying.
- Easy cleaning.



*Download recipes*



**50mm** HEIGHT **55cm** Ø

PE550

||||| EAN 8421078033325

1 UNIT



**JEPE1639**

## Electric paella pan

230 V - 2.000 W

- Diameter 38 cm.
- Depth 50 mm.
- Non-stick coating free of PFOA.
- Bee surface panel: improves antiadherence and transmits heat evenly.
- Removable adjustable thermostat of temperature.
- Glass lid.
- Steam outlet valve.
- Cold touch handles.
- Table carrying.
- Easy cleaning.
- Spatula included.



*Includes spatula for free*



**50mm** HEIGHT

||||| EAN 8421078037729 2 UNITS

**LIBRE DE PFOA** Ø **38cm**



**PE640**

## Electric paella pan

230 V - 1.600 W

- Diameter 34 cm.
- Depth 75 mm.
- Non-stick coating free of PFOA.
- Bee surface panel: improves antiadherence and transmits heat evenly.
- Removable adjustable thermostat of temperature.
- Glass lid.
- Steam outlet valve.
- Cold touch handles.
- Table carrying.
- Easy cleaning.
- Spatula included.

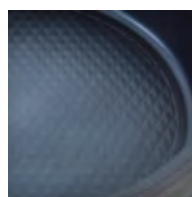

*Includes spatula for free*



**75mm** HEIGHT

||||| EAN 8421078035473 2 UNITS

**LIBRE DE PFOA** Ø **34cm**

## Electric barbecue with legs

230 V - 2.200 W

**JEBQ1001**

- Totally detachable.
- Grill with 2 levels for meat and fish.
- Stainless steel tray.
- "Long life" shielded resistance.
- Surface 400 x 230 mm.
- Tray / lower support.
- Two cooking options: table / standing.
- Standing height: 80 cm.
- Cook without fumes and odours.
- Adjustable thermostat of temperature.
- On pilot light.
- Easy cleaning.



**JEBQ1001**

||||| EAN 8421078035992

📦 4 UNITS



## Electric barbecue with legs

230 V - 1.800 W

**JEBQ1002**

- Removable aluminium plate with non-stick coating free of PFOA.
- Totally detachable.
- Stainless steel tray.
- "Long life" shielded resistance.
- Surface 400 x 240 mm.
- Tray / lower support.
- Two cooking options: table / standing.
- 2 side panels for working area.
- Windproof panel with top grille.
- Standing height: 80 cm.
- Cook without fumes and odours.
- Adjustable thermostat of temperature.
- On pilot light.
- Easy cleaning.



**JEBQ1002**

||||| EAN 8421078036166

📦 2 UNITS



PARRILLA DE ALUMINIO EXTRAÍBLE





**EBQ2**

**Electric barbecue "INDOOR BBQ"**

230 V - 2.000 W

- For indoor and outdoor use.
- New barbecue concept.
- Barbecue in your kitchen: cooks without smoke and odor.
- Aluminium body with spray protection.
- Stainless steel tray.
- Grid with non-stick coating free of PFOA.
- Grid with handle protected by silicone. 2 positions: meat / fish.
- Totally detachable.
- "Long life" shielded resistance.
- Surface: 40 x 26 cm.
- Removable cable cord.
- On switch.



||||| EAN 8421078035558

📦 3 UNITS

**BQ108**

**Electric barbecue**

230 V - 1.250 W

- Totally detachable.
- Die-cast aluminium grill plate. Surface 320 x 260 mm.
- Non-stick coating PFOA free.
- Cook without fumes and odours.
- Removable adjustable thermostat of temperature.
- Easy cleaning.
- Sauce tray.



||||| EAN 8421078035541

📦 4 UNITS



**BQ95**

**Electric barbecue**

2230 V - 2.000 W

- Totally detachable.
- Grill with 2 levels for meat and fish.
- Stainless steel tray.
- "Long life" shielded resistance.
- Cook without fumes and odours.
- Pilot light.
- Easy cleaning.

*Special for interiors*



||||| EAN 8421078033233

📦 4 UNITS

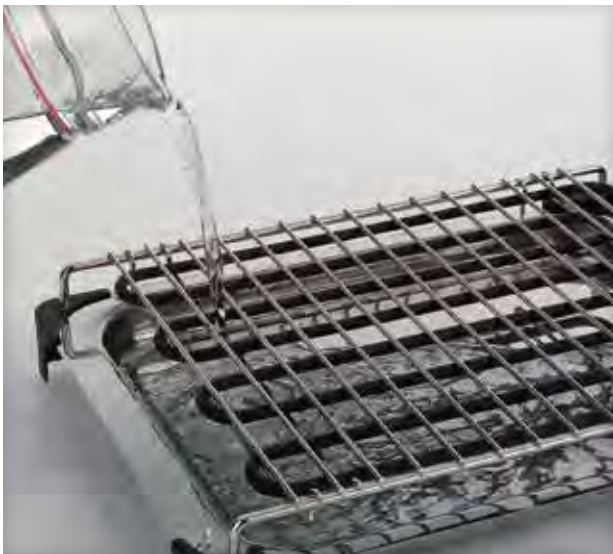
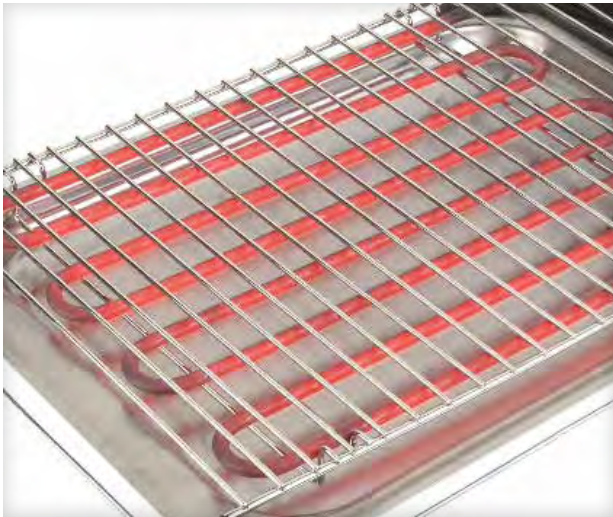

**BQ101**

## Electric barbecue **WITHOUT FUMES**

230 V - 2.400 W

- Totally detachable.
- Grill with 2 levels for meat and fish.
- High power.
- Stainless steel tray.
- Shielded resistance.
- Cook without fumes and odours.
- Easy cleaning.
- Manufactured in Spain.

*Special for  
interiors*



**BQ101**

||||| EAN 8421078022343

📦 4 UNITS





**GR266**



# Contact grill "3 in 1"

230 V - 1.000 W

- "Daikin" non-stick coating free of PFOA.
- Mixed plates: 270 x 140 mm.
- Adjustable upper plate special for hamburgers, entrecôte, sandwiches and fish.
- 180° open as a grill.
- Uniform roasting pressure.
- Cooks all kinds of fish and meat.
- Cold touch handle.
- 2 independent pilot lights: on / ready.
- Sauce tray.



Video

**GR266**

||||| EAN 8421078029731

📦 2 UNITS

**SET266**

## Includes GR266 + AC266

- Adjustable plates with non-stick coating.
- 2 fry pans included:
- Non-stick coating.
- Diameter 12 cm.
- Inox handle with silicone.
- Recipes included.

||||| EAN 8421078032496 📦 2 UNITS



**AC266**

## Accessory for grill GR266

||||| EAN 8421078032465 📦 4 UNITS



**R266**

## Replacement set of two pans

||||| EAN 8421078032816 📦 8 UNITS





**JEGR1107**

**Contact grill**

230 V - 1.000 W

- Non-stick coating free of PFOA.
- Plates: 225 x 140 mm.
- Floating hinge system.
- Cold touch handle.
- Uniform roasting pressure.
- Cooks all kinds of fish and meat.
- 2 independent pilot lights: on / ready.
- 180° open as a grill.
- Skid-resistance feet.
- Overheating safety device.
- Closing clip.



||||| EAN 8421078037989 6 UNITS

**JEGR1124**

**Contact grill**

230 V - 1.000 W

- 2 Plates: 23 x 14,5 cm.
- Floating hinge system.
- Uniform roasting pressure.
- Non-stick coating free of PFOA.
- 180° open as a grill.
- Cold touch handle.
- Sauce collecting tray.
- 2 independent pilot lights: on / ready.
- Closing clip.
- Skid-resistance feet.
- Overheating safety device.



||||| EAN 8421078039204 6 UNITS

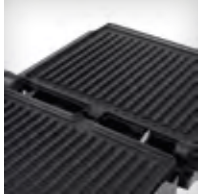

PLATES  
290 x 240 mm

**JEGR1595**

**Contact grill ribbed plates**

230 V - 2.000 W

- 180° open as a grill.
- Special floating hinge system on upper plate for the perfect cooking of extra volume foods.
- Uniform grill pressure.
- Non-stick coating free of PFOA.
- Overheat safety protection.
- Cold touch handles.
- 2 independent pilot lights.
- Plates: 29 x 24 Cm.
- Sauce collecting tray.



||||| EAN 8421078036913

📦 2 UNITS

**GR1100**



**Contact grill**

230 V - 2.000 W

- Die-casting aluminium body.
- Floating hinge system.
- Stainless steel handles.
- Mixed plates: 275 x 240 mm.
- Non-stick coating free of PFOA.
- 180° open as a grill.
- 6 position adjustable upper plate special for hamburgers, entrecôte, sandwiches and fish.
- 2 independent pilot lights: on / ready.
- Sauce tray.
- Closing clip for storage.

PLATES  
275 x 240 mm



**GR1100**

||||| EAN 8421078021285

📦 2 UNITS



**JEGR1106 / JEGR1913**

**BLACK  
STAINLESS  
STEEL  
SERIES**



PLATES  
225 x 146 mm

PLATES  
290 x 240 mm



**JEGR1106**

**Contact grill flat plates**

230 V - 750 W

- Non-stick coating free of PFOA.
- Plates: 225 x 146 mm.
- Floating hinge system.
- 180° open as a grill.
- Uniform roasting pressure.
- Cooks all kinds of fish and meat.
- Cold touch handle.
- 2 independent pilot lights: on / ready.
- Non slip feet.
- Closing clip.

**JEGR1913**

**Contact grill flat plates**

230 V - 2.000 W

- Non-stick coating free of PFOA.
- Special floating hinge system on upper plate for the perfect cooking of extra volume foods.
- 180° open as a grill.
- Overheat safety protection.
- Cold touch handles.
- Uniform grill pressure.
- 2 independent pilot lights:
- On / Ready.
- Plates: 290 x 240 mm.
- Sauce collecting tray.



||||| EAN 8421078037156 6 UDS

||||| EAN 8421078036906 2 UDS



**JEGR1450**

**AUTUMN  
NOVELTY**



## Contact grill ribbed plates

230 V - 2.000 W

- 180° open as a grill.
- Special floating hinge system on upper plate for the perfect cooking of extra volume foods.
- Uniform grill pressure.
- Adjustable temperature thermostat.
- Non-stick coating free of PFOA.
- Overheat safety protection.
- Cold touch handles.
- 2 independent pilot lights: On / Ready.
- Plates: 29,6 x 21,8 Cm.
- Sauce collecting tray.
- Skid-resistance feet.



**JEGR1450**

PLATES  
296 x 218 mm

||||| EAN 8421078038917

📦 2 UNITS

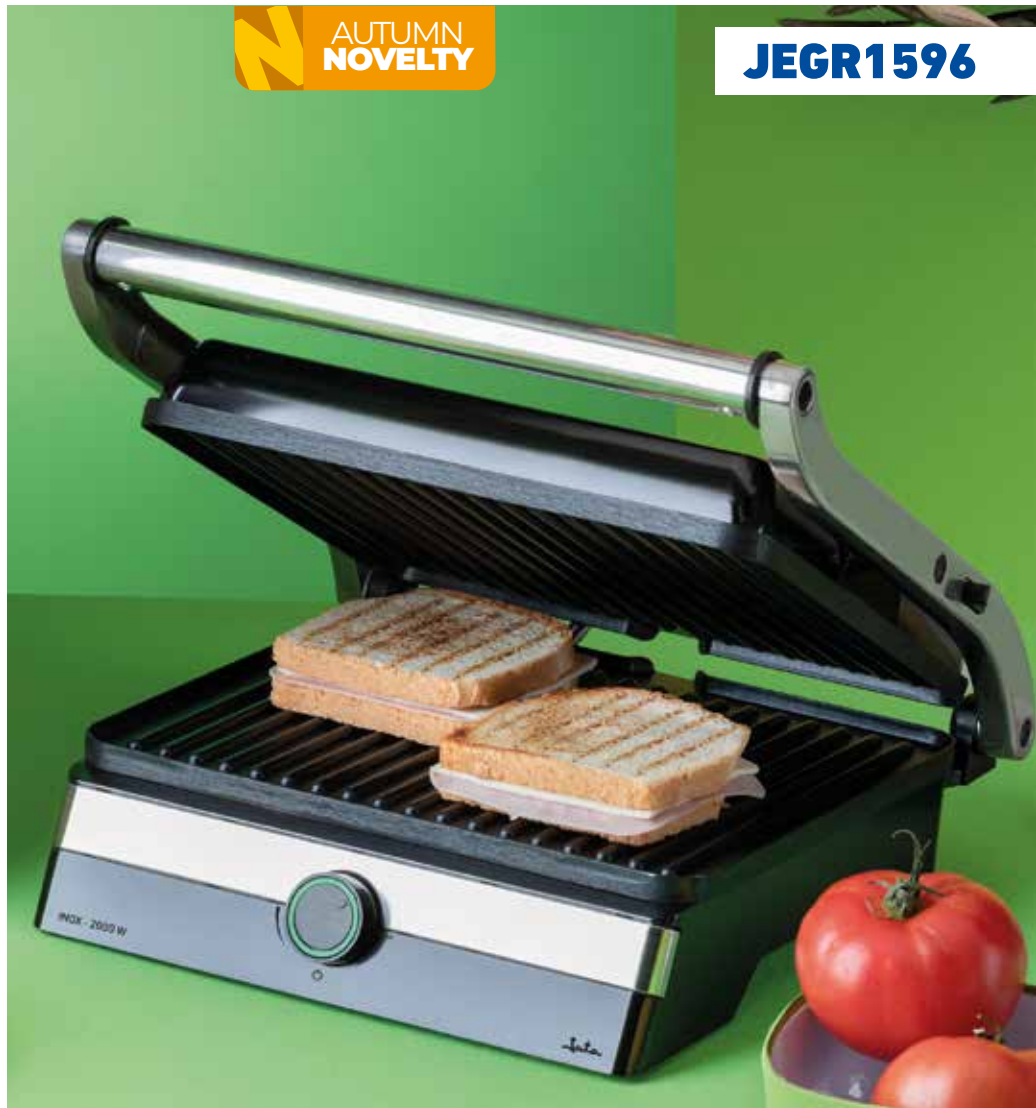

## Contact grill

230 V - 2.000 W

- 180° open as a grill.
- Grilled plates.
- Special floating hinge system on upper plate for the perfect cooking of extra volume foods.
- Uniform grill pressure.
- Non-stick coating free of PFOA.
- Overheat safety protection.
- Cold touch handles.
- Sauce collecting tray.
- Plates: 29 x 23,6 Cm.



PLATES  
29 x 236 mm

JEGR1596

||||| EAN 8421078038924

📦 2 UNITS



**JESW1232 / JESW1231**



**JESW1232 - WHITE**

||||| EAN 8421078036982

📦 6 UNITS



**JESW1231 - BLACK**

||||| EAN 8421078036715

📦 6 UNITS

## Sandwich maker

230 V - 750 W

- 2 full sandwiches "XXL".
- Plates with PFOA free non-stick coating.
- Perfect sealing.
- Quick and uniform toasting.
- 2 independent pilot lights: on / ready.
- Stand upright.
- Closing clip for storage.
- Easy cleaning.



**XXL**



## Sandwich maker

230 V - 1.400 W

- 4 full sandwiches "XXL".
- Plates with non-stick coating, PFOA free.
- Perfect sealing.
- Quick and uniform toasting.
- Closing clip for storage.
- 2 independent pilot lights: on / ready.
- Vertical storage.
- Cord storage.
- Easy cleaning.

*Family format*



**SW551 - WHITE**

||||| EAN 8421078035466

4 UNITS

**JESW1551 - BLACK**

||||| EAN 8421078038214

4 UNITS



## SW546

## Sandwich maker

230 V - 1.500 W

- 4 sandwiches.
- Plates with non-stick coating, PFOA free.
- Perfect sealing.
- Quick and uniform toasting.
- 2 independent pilot lights: on / ready.
- Vertical storage.
- Closing clip for storage.
- Easy cleaning.



||||| EAN 8421078032007

4 UNITS

**milker**  
by Jata

Prepare your VEGETABLE MILK  
fast, simple and nutritious

- No additives
- No sugars
- Freshly extracted
- 100% to your liking
- 100% natural

Prepare your  
**VEGETABLE MILK**  
in less than a minute!

Watch the  
**RECIPE**



**4 UNITS  
DISPLAY BOXES**  
26,5 x 40 x 42,5 cm

**JELV2350**

## Milker and hand BLENDER set

230 V - 400 W

- **Set includes:**
  - Graduated transparent beaker with 2 measures of 0.5 l and 1 l.
  - Ergonomic mortar to press the extract of the ingredients.
  - Measuring spoon.
  - Stainless steel filter grid.
  - Includes 5 sheets with easy and quick recipes.
  - BPA free.
  - Manufactured under the EP2814362 license.
- **Hand blender:**
  - Ergonomic handle
  - Detachable arm
  - highly solid stainless steel blades
  - On button.

- 4 stackable pieces: filter, mortar, measuring spoon and container.



**4 UNITS  
DISPLAY BOXES**  
27 x 26,5 x 29,5 cm

**JELV2300**

## Milker

- Graduated transparent beaker with 2 measures of 0.5 l and 1 l.
- Ergonomic mortar to press the extract of the ingredients.
- Stainless steel filter grid.
- Measuring spoon.
- 4 stackable pieces: filter, mortar, measuring spoon and container.
- Includes 5 sheets with easy and quick recipes.
- BPA free.
- Compatible with all blenders (not included).
- Manufactured under the EP2814362 license

||||| EAN 8421078038443 4 UNITS

||||| EAN 8421078038450 4 UNITS





**AUTUMN NOVELTY**

**JEEM2450**

# Emulsifier

Unscrewable stainless steel emulsifier filter with interchangeable discs to prepare thicker emulsions, ensure proper pressing of the pulp and easier cleaning.

• **Prepares all kinds of emulsions:**

- Sauces
- Purées
- Creams
- Fish stock
- Seeds
- Vegetables
- Roots
- Spices

- This is an upgrade of Jata's Milker, with which you can create unique textures, thanks to its interchangeable discs.
- Perfect for chefs and food lovers.

**Contains:**

- Filter with unscrewable base, 300 µ steel tube mesh and 3 interchangeable steel discs:
  - One solid disc.
  - One perforated disc (300 µ).
  - One perforated disc (500 µ).
  - One perforated disc (1000 µ).
- Top-quality bamboo mortar.
- Borosilicate glass jar.
- Bamboo lid.



**JEEM2450**  
 EAN 8421078039075  
 4 UNITS

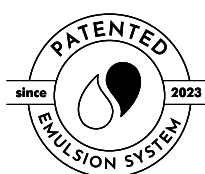



**JEBT1241**



# Glass blender

**230 V - 1.200 W**

- High performance power of 1,200 W.
- Professional AC motor.
- 6 resistant stainless steel blades.
- Graduated glass jug of 1.75 l. with pouring spout and transparent cap measuring 50 ml.
- 4 speed levels + pulse.
- Ice-crushing.
- Overheating safety device.
- Homologated safety system.
- Non-slip feet.



**JEBT1241**

||||| EAN 8421078037705

2 UNITS



**BT1056**

**PRO SERIES**

## Electronic inox blender, Tritan jar

**230 V - 2.000 W**

- Great Power 2.000 W (33.000 rpm)
- High performance AC motor.
- Integrated electronic action.
- Stainless steel body.
- TRITAN jar, light and maximum resistance. Capacity 2 l.
- BPA free.
- Stainless steel Japanese blades.
- Electronic speed control knob.
- Pulse and functioning knobs.
- **3 automatic functions:**
  - Smoothie.
  - Sauce.
  - Ice-crushing.
- Lid with dispenser and security closing.
- Pusher included.
- Homologated safety system.
- Indicator lights.
- Integrated cord storage.



||||| EAN 8421078035244

2 UNITS

## Glass blender 230 V - 1.200 W

- Great power 1.200 W.
- Professional AC motor.
- 6 extra large stainless-steel serrated blades.
- Glass jar 1,5 l.
- 3 speeds + pulse.
- Ice-crushing.
- Millimetre detachable jar.
- Homologated safety system.
- Anti-sliding base.



**BT795**

||||| EAN 8421078035510

📦 2 UNITS



**BT795**

**RED  
SERIES**

## Inox glass blender 230 V - 1.500 W

- AC professional performance engine.
- Great power due to 1500 W
- Stainless steel body.
- Glass jar 1,5 l.
- 2 speeds + turbo.
- Wide filling mouth with transparent stopper.
- Stainless steel serrated blade, high performance.
- Ice-crushing.
- Non-slip base.
- Homologated safety lock system.
- Millimetre detachable glass jug.
- Indicator light.



**JEBT1500**

||||| EAN 8421078036241

📦 2 UNITS



**JEBT1500**

**BLACK  
STAINLESS  
STEEL  
SERIES**



**BT604N**



**BT5030**

**BT604N - BT5030**

**Inox glass blender  
230 V - 1.300 W**

- Glass jar 1,5 l.
- 2 speeds + pulse.
- Stainless steel body.
- Stainless steel serrated blade.
- Ice-crushing.
- Homologated safety system.
- Millimetre detachable jar.
- Indicator light.
- Voltage 230 V.



**BT604N**  
 EAN 8421078034681  
 3 UNITS

**BT5030**  
 EAN 8421078035336  
 2 UNITS



**JEBT1265**



**BT265**

**JEBT1265 - BT265**

**Glass blender  
230 V - 1.300 W**

- Great power 1.300 W.
- Professional AC motor.
- Glass jar 1,5 l.
- 2 speeds + pulse.
- Homologated safety system.
- Millimetre detachable jar.
- Ice-crushing.
- High resistance stainless steel blade.
- Anti-sliding base.



**JEBT1265**  
 EAN 842107807699  
 4 UNITS

**BT265**  
 EAN 8421078035077  
 4 UNITS





**AUTUMN  
NOVELTY**

**JEBT1243**

## Glass blender

**230 V - 1.300 W**

- High performance power of 1.300 W.
- High-performance AC motor.
- 6 resistant stainless steel blades.
- Graduated glass jug of 1.50 L
- Pouring spout and transparent cap measuring 30 ml.
- 4 speed levels + pulse.
- Ice-crushing.
- Overheating safety device.
- Cord length: 1,20 m
- Cord storage.
- Homologated safety system.
- Non-slip feet.

**JEBT1243**

||||| EAN 8421078038535

📦 2 UNITS

**SEIS CUCHILLAS  
INOXIDABLE**



**INOX**

**AC  
MOTOR**

**1300 W**



**BT797**



**Inox glass blender**  
**230 V - 1.300 W**

- Glass jar 1,5 l.
- 2 speeds + pulse.
- Stainless steel body.
- Stainless steel serrated blade.
- Ice-crushing.
- Homologated safety system.
- Millimetre detachable jar.
- Indicator light.



**BT797**

||||| EAN 8421078034698

📦 3 UNITS

**JEFT1001**



**Personal blender**  
**230 V - 600 W**

- Double function graduated glass (glass/bottle) with 600 ml capacity.
- Light and portable glass/bottle.
- Sports bottle with lid with carrying handle and spout.
- BPA free.
- Bottle suitable for dishwasher.
- Approved safety lock system.
- 4 removable easy-to-clean stainless steel blades for a homogeneous mixture.
- Two-speed selector + Pulse.
- Perfect for fruit, vegetables and ice.
- Suitable for nuts.
- Non-slip base.
- Size: 35 x 12,4 cm



**JEFT1001**

||||| EAN 8421078037125

📦 6 UNITS

## Inox stick blender 230 V - 400 W

- Removable stainless steel stick.
- Stainless steel double blade.
- 2 pushers. 2 speeds.
- Ergonomic handle.
- Hanging ring.



JEBT1124

||||| EAN 8421078038788

📦 9 UNITS

**AUTUMN  
NOVELTY**



**JEBT1124**

## Inox stick blender 230 V - 500 W

- Ergonomic handle.
- 2 pushers. 2 speeds.
- Removable stainless-steel stick.
- Beat, chop and crush.
- 4 Stainless-steel blades, great strength.
- RPM: 17000



JEBT1906

||||| EAN 8421078038764

📦 6 UNITS

**AUTUMN  
NOVELTY**



**JEBT1906**





**BT126**

**Inox stick blender  
230 V - 400 W**

- Removable stainless steel stick.
- Stainless steel blade.
- On button.
- Ergonomic handle.

EAN 8421078033240

9 UNITS



INCLUDES  
**800 ml  
MEASURING  
GLASS**



**BT158**

**Inox stick blender  
230 V - 700 W**

- Great power 700 W.
- Removable stainless steel stick.
- Stainless steel double blade.
- 2 pushers. 2 speeds.
- Ergonomic handle.
- Measure cup included, 800 ml.

EAN 8421078033257

6 UNITS



ACERO INOX



6 UNITS  
DISPLAY BOXES  
30 x 39 x 40 cm



Storage box  
included



**JEFT1945**

**Electronic inox stick blender  
230 V - 800 W**

- Electronic speed control knob.
- Stainless-steel double blade, great strength.
- Removable stainless steel stick.
- 2 pushers.
- Turbo function.
- Ergonomic handle.
- Hanging ring.
- Storage box included.
- Anchorage system.
- Anti-splash design.
- Ergonomic design.

EAN 8421078036210

6 UNITS



ACERO INOX

INCLUDES  
**500 ml  
MEASURING  
GLASS**



INCLUDES  
**ACCESORIES**



2

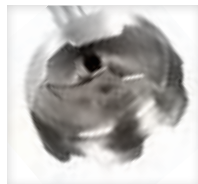

**JEFT1790**

**Electronic inox stick blender  
230 V - Máx. 800 W**

- Electronic speed control knob.
- Stainless-steel double blade, great strength.
- Removable stainless steel stick.
- 2 pushers.
- **Accesories included:**
  - Chopper.
  - 500 ml. measuring cup.
- Turbo function.
- Ergonomic handle.
- Hanging ring.
- Anchorage system.
- Anti-splash design.
- Ergonomic design.

EAN 8421078036890

4 UNITS



ACERO INOX

## Electronic inox stick blender 230 V - Máx. 900 W

- Stainless-steel double blade, great strength.
- Beat, chop and crush.
- Electronic speed control knob.
- Safety push button.
- Ergonomic handle.
- Removable stainless-steel stick.
- Measure cup included, 700 ml.



INCLUDES  
**700 ml**  
MEASURING  
GLASS



BLOQUEO DE  
SEGURIDAD



LIBRE DE  
PFOA

JEBT1852

||||| EAN 8421078037217

📦 6 UNITS



## BT175

## Electronic inox stick blender 230 V - Máx. 900 W

- Electronic speed control knob.
- Safety push button.
- Removable stainless-steel stick.
- Stainless-steel double blade, great strength.
- Ergonomic handle.
- Measure cup included, 700 ml.

||||| EAN 8421078034452

📦 6 UNITS



INOX



ACERO INOX



INCLUDES  
**700 ml**  
MEASURING  
GLASS



## JEBT1853

## Inox stick blender 230 V - 1.000 W

- Great power 1.000 W
- Spiral cable for greater autonomy.
- Removable stainless steel stick.
- 4 Stainless-steel blades, great strength.
- 2 pushers. 2 speeds.
- Ergonomic handle.
- Measure cup included, 700 ml.

||||| EAN 8421078037972

📦 6 UNITS



INOX



ACERO INOX

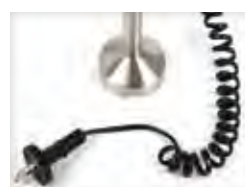

Spiral cable



INCLUDES  
**700 ml**  
MEASURING  
GLASS





BT176

BT5025

INCLUDES  
600 ml  
MEASURING  
GLASS



**BT176 - BT5025**

**Electronic inox stick blender  
230 V - 1.000 W**

- Great power 1.000 W.
- Electronic speed control knob.
- Removable stainless steel stick.
- Stainless steel double blade.
- Power pusher.
- Ergonomic handle.
- Hanging ring.
- Measure cup included, 600 ml.



ACERO INOX

**BT176 - ORANGE**

||||| EAN 8421078034728

6 UNITS

**BT5025 - BLACK**

||||| EAN 8421078035305

6 UNITS

INCLUDES  
ACCESORIES

3



**BT177**

**Electronic inox stick blender  
230 V - 1.000 W**

- Electronic speed control knob.
- Stainless steel double blade.
- Removable stainless-steel stick.
- Power pusher.
- Ergonomic handle.
- **Accessories included:**
  - Whisker.
  - Chopper.
  - Measure cup 600 ml.



ACERO INOX

||||| EAN 8421078034735

4 UNITS



INCLUDES  
600 ml  
MEASURING  
GLASS

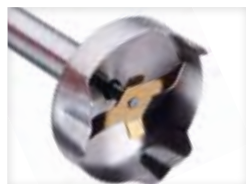

**BT185**

**Electronic inox stick blender  
230 V - 1.000 W**

- Electronic speed control knob.
- Titanium double blade of great strength.
- Removable stainless steel stick.
- 2 pushers.
- Stainless steel frontal panel.
- 600 ml measuring cup with lid.
- Indicator light.
- Soft touch ergonomic handle.
- Hanging ring.



TITANIUM

||||| EAN 8421078033639

6 UNITS



## BT166 Electronic inox stick blender 230 V - 1.000 W

- Titanium double blade.
- Ergonomic handle.
- Electronic speed control knob.
- Hanging ring.
- Removable stainless-steel stick.
- Measure cup included, 500 ml.
- Power pusher.
- Available in 3 colours.



||||| EAN 8421078035404

📦 9 UNITS

9 UNITS  
DISPLAY BOXES  
31,5 x 32 x 50 cm



INCLUDES  
500 ml  
MEASURING  
GLASS



## Inox stick blender 230 V - 1.000 W

- Titanium double blade of great strength.
- Great power 1.000 W.
- Electronic speed control knob.
- Removable stainless steel stick.
- Soft touch ergonomic handle.
- Stainless steel frontal panel.
- **Accessories included:**
  - 600 ml measuring cup with lid.
  - Whisker.
  - Chopper.
- Indicator light.
- Hanging ring.
- 2 pushers.

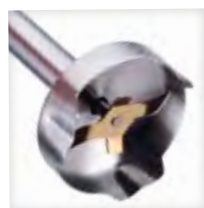

BT199



JEBT5026



## BT199 - JEBT5026

INCLUDES **3**  
ACCESORIES

INCLUDES  
600 ml  
MEASURING  
GLASS



BT199 - WHITE

||||| EAN 8421078033646

📦 4 UNITS

JEBT5026 - AZUL

||||| EAN 8421078035749

📦 4 UNITS

INCLUDES  
800 ml  
MEASURING  
GLASS



INCLUDES  
ACCESORIES

2



**BT169**

**Electronic inox stick blender  
230 V - 1.200 W**

- Electronic speed control knob.
- Stainless steel double blade.
- Removable stainless-steel stick.
- 2 speed pushers.
- Ergonomic handle.
- **Accessories included:**
  - Chopper.
  - Measure cup 800 ml.



ACERO INOX

||||| EAN 8421078035411

📦 6 UNITS

**JEBT1855**



PIE  
EXTRA  
LARGO  
26 CM

**Extra long stainless  
steel hand blender**

**230 V - Máx. 1.200 W**

- Extra long stainless steel arm.
- Great power 1.200 W.
- 4 Stainless-steel blades, great strength.
- Beat, chop and crush.
- Spiral cable for greater autonomy.
- Electronic speed control knob.
- TURBO button.
- Detachable arm for easy cleaning
- One-click anchoring system, safer and easier.
- Ergonomic handle.
- Cord length 1,50 m.
- Maximum speed button.



ACERO INOX

**JEBT1855**

||||| EAN 8421078038030

📦 6 UNITS



**JEFT1788**

## Turbo Power inox stick blender

**230 V - 1.200 W**

- Turbo Power hand blender.
- 1.200 w power.
- Adjustable speed selector and Turbo function.
- Ergonomic design.
- Easy anchoring and disassembly system.
- Removable stainless-steel stick.
- Hanging ring.
- 4 Stainless-steel blades, great strength.
- Beat, chop and crush.
- RPM: 17000 +/-10%

**JEFT1788**

||||| EAN 8421078038771

📦 6 UNITS







**2 en 1 container**  
Mixture and storage container



**BT159**

**Electronic inox stick blender  
230 V - 1.200 W**

- Electronic speed control knob.
- Stainless steel double blade.
- Removable stainless-steel stick.
- 2 speed pushers.
- Ergonomic handle.
- Container of 2 l.



ACERO INOX



||||| EAN 8421078035374

6 UNITS

**6 UNITS  
DISPLAY BOXES**  
37,8 x 27,8 x 24 cm



INCLUDES  
**600 ml  
MEASURING  
GLASS**



**JEBT1851**

**Electronic inox stick blender  
230 V - Máx. 1.500 W**

- Great power Max. 1500 W.
- Ergonomic handle.
- Electronic speed control knob.
- Turbo function.
- Hanging ring.
- Beat, chop and crush.
- Removable stainless-steel stick.
- 4 Stainless-steel blades, great strength.
- Measuring cup included, 600 ml.
- RPM: 9000-13002



||||| EAN 8421078037095

6 UNITS

INCLUDES **2**  
**ACCESORIES**

INCLUDES  
**700 ml  
MEASURING  
GLASS**



**JEBT1791**

**Electronic inox stick blender  
230 V - Máx. 1.500 W**

- Electronic speed control knob.
- 4 Stainless-steel blades, great strength.
- Removable stainless-steel stick.
- 2 speed pushers.
- Ergonomic handle.
- Hanging ring.
- **Accessories included:**
  - Chopper.
  - 700 ml measure cup with lid.



ACERO INOX

||||| EAN 8421078038047

4 UNITS



## Kneader / Mixer

230 V - 400 W

- 5 speeds + turbo.
- **4 exchangeable accessories.**
  - 2 spirals for kneading.
  - 2 rods for mixing.
- Energy efficiency thanks to its copper motor.
- Easy cleaning.



JEMA1240

||||| EAN 8421078038818

📦 6 UNITS





**BT575**

**Hand blender / Mixer**

230 V - 400 W

- 5 speeds + turbo.
- Easy cleaning.
- **5 exchangeable accessories.**
  - 2 spirals for kneading.
  - 2 rods for mixing.
  - Stainless steel stick blender.



||||| EAN 8421078033967

📦 6 UNITS

**MZ670**

**Kneader / Mixer with bowl**

230 V - 350 W

- Recipiente em aço inoxidável, de grande capacidade 3,5 l.
- 5 velocidades.
- Base rotativa para misturar e amassar.
- Controlo deslizante para ajustar a posição do recipiente.
- 2 espirais para amassar.
- 2 varinhas para bater.
- Limpeza fácil.
- Base anti-deslizamento.



||||| EAN 8421078034568

📦 4 UNITS

**FP500P**

**Kneader / Mixer with bowl**

230 V - 1.000 W

- 100% stainless steel bowl. Capacity 5 l.
- Accessories:
  - Dough hook, special for heavy dough.
  - Egg whisk.
  - Mixing beater.
  - Spatula.
- Electronic speed control knob.
- Splash cover with lid to refilling.
- Tilt button.
- Easy cleaning.
- Skid-resistance feet.



||||| EAN 8421078034292

📦 2 UNITS





**JEMA5502 / JEMA1502**

## Kneader / Mixer with bowl

230 V - 1.000 W

- 100% stainless steel bowl. Capacity 5 l.
- Electronic speed control knob.
- Splash cover with lid to refilling.
- Rotary movement.
- 6 speeds + Pulse function.
- Tilt button.
- **Accessories:**
  - Dough hook, special for heavy dough.
  - Egg whisk.
  - Mixing beater.
- Easy cleaning.
- Skid-resistance feet.

**JEMA5502 - BLACK**

||||| EAN 8421078037903

📦 2 UNITS



**JEMA1502 - RED**

||||| EAN 8421078036937

📦 2 UNITS



**JEFR1221**



**1,5 l Oil-free deep fryer**

230 V - 1.000 W

**1,5L**

- Get tasty and crispy results, without giving up your health.
- No oil.
- Oil-free deep fryer with 1000 w power.
- Adjustable temperature control from 80 to 200°C.
- Constant temperature by rapid air circulation.
- Capacity 1,5 L and basket for frying without oil, up to 300 g
- Rations for 2-3 people quickly and efficiently.
- Non-stick basket and compatible with any dishwasher.
- Compact and smart design.
- Timer 30 minutes.
- 2 independent light buttons: ON / OFF.
- Automatic switch off
- Overheating protection device.
- BPA free.
- Basket with handle.
- Bowl dimensions: Diameter: 15.5 cm - Height: 9.5 cm



**JEFR1221**

||||| EAN 8421078036265

📦 2 UNITS

**JEFR1223 - JEFR5392**



**2 l Oil-free air fryer**

230 V - 1.000 W

**2L**

- Oil-free deep fryer with 1000 w power.
- High speed air circulation technology.
- Capacity 2 L
- Timer 30 minutes.
- Non-slip feet.
- Adjustable temperature control from 80 to 200 °C.
- 17 cm diameter basket with non-stick coating and removable grid.
- BPA free.
- Overheating safety system.
- Automatic switch-off.
- Basket diameter 17 cm
- Removable inner basket.



**JEFR1223 - BRANCO**

||||| EAN 8421078037224

📦 2 UNITS

**JEFR5392 - VERDE**

||||| EAN 8421078037392

📦 2 UNITS



## 2 l Oil-free air fryer

230 V - 1.000 W

2L

- Oil-free deep fryer with 1000 w power.
- High speed air circulation technology.
- Capacity 2 L
- Timer 30 minutes.
- Adjustable temperature control from 80 to 200°C.
- Bowl dimensions: Diameter: 16 cm - Height: 9.5 cm
- Non-stick coated basket.
- Automatic switch-off.
- BPA free.
- Basket with handle.



JEFR1222

||||| EAN 8421078036661

📦 2 UNITS



JEFR1222

All our **recipes** are available to download at:

[www.jata.es](http://www.jata.es)



## Set of 6 accessories for air fryer

- **6-piece set consisting of:**
  - 11cm high stainless steel cake barrel.
  - Stainless steel pizza pan.
  - Platinum silicone mold for cupcakes and flans.
  - Platinum silicone glove.
  - Tongs.
  - Platinum silicone mat.
- Perfect for fryers from 4l onwards.
- Items diameter: 20-21 cm
- Non-stick, very heat resistant and easy to clean.
- Made with BPA free materials.



JESA2090

||||| EAN 8421078037682

📦 4 UNITS



JESA2090



**JEFR1226**



LIBRE DE BPA **SIN ACEITE**

**4l**

**4 l Oil-free air fryer**

230 V - 1.400 W

- Cook with 80% less fat.
- High speed circulation technology.
- Adjustable temperature control. 200°C max.
- Smart digital screen:
  - ON /OFF switch.
  - Time / temperature selector.
  - Temperature selectors.
- Pilot lights.
- 4 l. capacity.
- Non-stick basket for easy cleaning.
- Non-stick grid.
- Compact and smart design.
- Timer 60 minutes.
- Non-slip feet.



**JEFR1226**

||||| EAN 8421078037385

2 UNITS



**4,2l**

**JEFR1224**

**4,2 l Oil-free deep fryer**

230 V - 1.300 W

- Healthy and clean cooking.
- Capacity 4,2 l.
- Transport handles.
- 2 independent light indicators: Timer / Temperature.
- Easy handling.
- Non-stick basket with handle.
- Basket diameter: 22 cm
- Adjustable temperature control. 200°C max.
- Timer 30 minutes.
- Cord length: 1 m
- BPA free.

**SIN ACEITE** **LIBRE DE BPA**

||||| EAN 8421078037170

2 UNITS



**4,5l**

**JEFR1227**

**4,5 l Oil-free deep fryer**

230 V - 1.500 W

- Healthy, clean and smoke-free cooking.
- Capacity 4,5 l.
- 100 unds of perforated vegetable paper of 20 cm included
- 2 independent indicators: Timer / Temperature.
- Easy handling.
- Non-stick basket with handle.
- Basket diameter: 21,5 cm. Height: 11 cm
- Adjustable temperature control. 200°C max.
- Overheating safety device.
- Timer 30 minutes.
- Cord length: 1 M.
- BPA free.

Includes  
*100 sheets*  
Ø20 cm  
baking paper

**SIN ACEITE** **LIBRE DE BPA**

||||| EAN 8421078037668

2 UNITS

## 5 l Oil-free deep fryer

230 V - 1.300 W

5l

- No oil.
- Adjustable temperature control. 200°C max.
- Smart digital screen:
  - ON /OFF switch.
  - 8 cooking programs.
  - Time / Temperature selector.
- Capacity 5 L
- Non-stick basket with handle.
- Compact and smart design.
- Timer 30 minutes.
- Constant temperature by rapid air circulation.
- BPA free.



JEFR1225

||||| EAN 8421078036654

📦 2 UNITS



JEFR1225

## 5 l Oil-free deep fryer 5 l

230 V - 1.450 W

5l

- No oil.
- Capacity 5 L
- Adjustable temperature control. 200°C max.
- Compact and smart design.
- Control panel:
  - ON /OFF switch.
  - Time / Temperature selector.
  - Time indicator.
  - Temperature indicator
- Non-stick basket.
- Constant temperature by rapid air circulation.
- Timer 60 minutes.
- Basket diameter: 23 cm. Height: 13 cm
- BPA free.



JEFR1229

||||| EAN 8421078037712

📦 2 UNITS



JEFR1229



6,2L

**JEFR1230**

## 6,2 l Air fryer with window

230 V - 1.700 W

- Oil-free cooking.
- Adjustable temperature control from 60° to 200°C.
- Large multifunction LED touch panel.
- 6.2 L large capacity basket.
- 21 x 21 x 13 cm
- Non-stick basket with handle.
- Transparent viewing window to monitor the progress of cooking.
- 12 preset cooking programs.
- Cord length 1 m
- Vintage design.
- Overheating safety device.
- Non-slip feet.
- Constant temperature by rapid air circulation.
- BPA free.
- Measures: 26,5 x 32,5 x 32,5 cm.



||||| EAN 8421078038313

📦 2 UNITS

**JEFR1270**

SPRING NOVELTY



## 7 l Oil-free air fryer

7L

230 V - 1.600 W

- Smart digital screen.
- Transparent window, perfect for checking the cooking status at any time.
- Non-stick basket with handle.
- 7L Capacity
- Compact and elegant design.
- Timer 60 minutes.
- 6 pre-configured cooking programs
- Cook with 80% less fat.
- Constant temperature by rapid air circulation.
- Adjustable temperature control. 200°C max.
- Anti-sliding base.
- BPA free.



**JEFR1270**

||||| EAN 8421078038665

📦 2 UNITS





AUTUMN  
NOVELTY

**JEFR1242**

## 8 l Double resistance air fryer

230 V - 2.100 W

- No oil.
- Constant temperature by rapid air circulation.
- Double resistance (up and down) for better heat distribution and time savings.
- **Smart digital screen:**
  - ON /OFF switch.
  - 10 pre-configured cooking programs
  - Time / Temperature selector.
- 8 L large capacity basket.
- 27,3 x 26,4 x 13,1 cm
- Adjustable temperature control. 200°C max.
- Cook with 80% less fat.
- Non-stick basket with handle.
- Timer 60 minutes.
- Anti-sliding base.

8L



JEFR1242

||||| EAN 8421078038757

📦 2 UNITS



FUNCIONES  
PRE-PROGRAMADAS



**JEFR1228**

## 9 l Oil-free deep fryer 2 baskets

230 V - 2.700 W

- 2700 W oil-free deep fryer.
- Multifunction control panel.
- High speed air circulation technology.
- Capacity 9 l:  
Basket 5,5 l. + basket 3,5 l.
- Timer 0-60 min.
- Adjustable temperature control from 80 to 200 °C
- Non-stick baskets.
- Automatic shut-off.
- BPA free.
- Baskets with handles.
- Two different ways of cooking and finishing at the same time.
- Independent programming of the baskets.
- 8 cooking functions.
- Overheating protection.
- Non-slip base.



||||| EAN 8421078037446

1 UNIT

9l

**JEFR1816**

AUTUMN  
NOVELTY



## 16 l Oven multifunction air fryer

230 V - 1.400 W

- 4 functions: rôtisserie, oven, grill and convection.
- Capacity 16 l.
- Timer 60 minutes.
- Inner working light.
- Adjustable thermostat of temperature.
- Accessories included: Baking tray, fryer basket, oven rack.
- Tip up door.
- Pilot light.
- Out-side measures: 34 x 33,7 x 33,8 cm
- Inner measurements: 26.6 x 26.5 x 21.8 cm.
- Non-slip feet.



**JEFR1816**

||||| EAN 8421078039129

1 UNIT

16l



**FR326E / FR5600**



## Inox deep fryer 1,3l

230 V - 1.000 W

- Non-stick ceramic coating free of PFOA and PTFE.
- Capacity 1,3 l.
- 100% metallic body.
- Anti-fingerprint metallic body.
- Adjustable thermostat of temperature.
- Glass lid with handle.
- Built-in resistance.
- Basket with handle.
- Lateral handles.
- Pilot light.
- Easy cleaning.

**FR326E - INOX**

||||| EAN 8421078021742

📦 4 UNITS



**FR5600 - PRETO**

||||| EAN 8421078035787

📦 4 UNITS







**FR115**

**Inox deep fryer**

230 V - 1.000 W

1,5L

- Immersed inox resistance.
- Stainless steel body.
- Removable enamelled oil tank.
- Detachable 100% for easy cleaning.
- Basket with handle.
- Adjustable thermostat of temperature.
- Anti-flavour mix "cool zone" system.
- Anti-involuntary use security system.
- On and ready pilot lights.
- Stainless steel lid with handle.
- Lateral handles.
- Cord storage.



||||| EAN 8421078033356 4 UNITS

**FR278**

**Deep fryer**

230 V - 2.000 W

2,5L

- Immersed inox resistance.
- Removable enamelled oil tank.
- Detachable 100% for easy cleaning.
- Adjustable thermostat of temperature.
- Anti-flavour mix "cool zone" system.
- Anti-involuntary use security system.
- Cold touch housing.
- Basket with great capacity and foldable handle.
- Filter on lid.
- On and ready pilot lights.
- Lid with handle and window suitable for placing during frying.
- Lateral handles.



||||| EAN 8421078031000 4 UNITS



**FR680**

**Inox deep fryer "Filtra Plus"**

230 V - 2.000 W

3,2L

- Immersed inox resistance.
- Stainless steel body.
- "Filtra Plus", special mesh for oil filtering.
- Basket with great capacity and foldable handle.
- Removable enamelled oil tank.
- Detachable 100% for easy cleaning.
- Adjustable thermostat of temperature.
- Anti-flavour mix "cool zone" system.
- Anti-involuntary use security system.
- On and ready pilot lights.
- Lid with handle and window. Suitable for placing during frying.
- Lateral handles.
- Integrated cord storage.



||||| EAN 8421078034896 2 UNITS

## Inox deep fryer

230 V - 2.000 W

3,2l

- Immersed inox resistance.
- Stainless steel body.
- Basket with great capacity and foldable handle.
- Removable enamelled oil tank.
- Detachable 100% for easy cleaning.
- Adjustable thermostat of temperature.
- Anti-flavour mix "cool zone" system.
- Anti-involuntary use security system.
- On and ready pilot lights.
- Stainless steel lid with handle. Suitable for placing during frying.
- Lateral handles.
- Integrated cord storage.



FR678



FR678

||||| EAN 8421078034889

📦 2 UNITS

## Inox deep fryer

230 V - 2.000 W

4l

- Immersed inox resistance.
- Stainless steel body.
- 2 medium baskets and 1 big basket.
- Enamelled oil tank with capacity for: 1 basket of 27 x 22 cm. or 2 baskets of 12,5 x 20 cm.
- Simultaneous use of the 2 medium baskets for cooking different food.
- Detachable 100% for easy cleaning.
- Adjustable thermostat of temperature.
- Anti-flavour mix "cool zone" system.
- Anti-involuntary use security system.
- Removable and washable filter.
- On and ready pilot lights.
- 3 baskets and 2 handles included.
- Stainless steel lid with handle and window.
- Lateral handles.



FR700



FR700

||||| EAN 8421078030775

📦 2 UNITS



**INTERNAL MEASUREMENTS**  
L x W x H cm  
25x22x15

**JEHN0910**

**Oven**

230 V - 800 W

- Oven, grill.
- Capacity 10 l.
- Timer 30 minutes.
- Stainless steel heating elements.
- Adjustable thermostat of temperature.
- Tray.
- Wire rack.
- Tip up door with double glass.
- Pilot light.
- Out-side measures: 37 x 27 x 23 cm.

||||| EAN 8421078036012

2 UNITS



**INTERNAL MEASUREMENTS**  
L x W x H cm  
26,5x25,5x14

**HN916**

**Oven**

230 V - 1.200 W

- Oven, grill.
- Capacity 16 l.
- Timer 60 minutes.
- Stainless steel heating elements.
- Adjustable thermostat of temperature.
- Tray.
- Wire rack.
- Handle for tray and rack.
- Tip up door.
- Pilot light.
- Out-side measures: 39 x 29 x 25 cm.

||||| EAN 8421078033677

1 UNIT



**INTERNAL MEASUREMENTS**  
L x W x H cm  
30,5x27,5x14

**HN921**

**Oven**

230 V - 1.380 W

- Oven, grill.
- Capacity 21 l.
- Timer 60 minutes.
- Stainless steel heating elements.
- Adjustable thermostat of temperature.
- Tray.
- Wire rack.
- Handle for tray and rack.
- Tip up door.
- Removable tray for easy cleaning.
- Pilot light.
- Out-side measures: 44,5 x 31 x 28,5 cm.

||||| EAN 8421078033684

1 UNIT



**INTERNAL MEASUREMENTS**  
L x W x H cm  
33,5x31,5x17

**HN928**

**Oven**

230 V - 1.500 W

- Oven, grill.
- Capacity 28 l.
- Timer 60 minutes.
- Stainless steel heating elements.
- Adjustable thermostat of temperature.
- Tray.
- Wire rack.
- Handle for tray and rack.
- Tip up door.
- Removable tray for easy cleaning.
- Pilot light.
- Out-side measures: 48 x 39 x 31 cm.

||||| EAN 8421078033691

1 UNIT

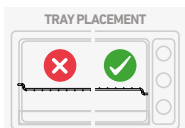



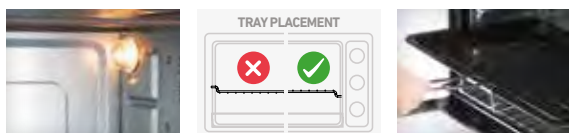

### HN936

## Oven rôtisserie

230 V - 1.500 W

**AIR FRYER FUNCTION**

- 4 functions: rôtisserie, oven, grill and convection.
- Capacity 36 l.
- Timer 60 minutes.
- Rotisserie: accessory for roasting chicken.
- Stainless steel heating elements.
- Inner light.
- Adjustable thermostat of temperature.
- Tray.
- Wire rack.
- Handle for tray and rack.
- Rotisserie tray.
- Tip up door.
- Removable tray for easy cleaning.
- Pilot light.
- Out-side measures: 51 x 40,5 x 33 cm.

36 L CAPACIDAD
ROTISSERIE
GRILL
CONVECCIÓN
LUZ INTERIOR
1500 W
60' TEMPORIZADOR

EAN 8421078033714 1 UNIT

INTERNAL MEASUREMENTS  
L x W x H cm  
36x32x20

### HN966

## Oven rôtisserie

230 V - 2.200 W

**AIR FRYER FUNCTION**

- 4 functions: rôtisserie, oven, grill and convection.
- Capacity 66 l.
- Timer 60 minutes.
- Rotisserie: accessory for roasting chicken.
- Stainless steel heating elements.
- Inner light.
- Adjustable thermostat of temperature.
- Tray.
- Wire rack.
- Handle for tray and rack.
- Rotisserie tray.
- Tip up door.
- Removable tray for easy cleaning.
- Pilot light.
- Out-side measures: 64 x 40 x 40 cm.

66 L CAPACIDAD
LUZ INTERIOR
2200 W
CONVECCIÓN
GRILL
ROTISSERIE
60' TEMPORIZADOR

EAN 84210733738 1 UNIT

INTERNAL MEASUREMENTS  
L x W x H cm  
48,5x37x33

### Oven rôtisserie

230 V - 2.000 W

**AIR FRYER FUNCTION**

- 4 functions: rôtisserie, oven, grill and convection.
- Capacity 45 l.
- Timer 60 minutes.
- Rotisserie: accessory for roasting chicken.
- Stainless steel heating elements.
- Inner light.
- Adjustable thermostat of temperature.
- Tray.
- Wire rack.
- Handle for tray and rack.
- Rotisserie tray.
- Tip up door.
- Removable tray for easy cleaning.
- Pilot light.
- Out-side measures: 56 x 37 x 35,5 cm.

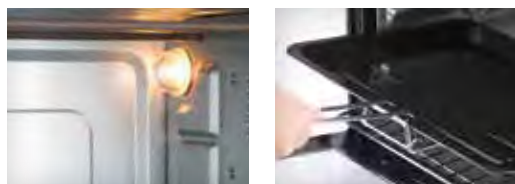

### HN945



Download our special oven recipes in [www.jata.es](http://www.jata.es)



**HN945**  
 EAN 8421078033721  
 1 UNIT

45 L CAPACIDAD
ROTISSERIE
GRILL
CONVECCIÓN
LUZ INTERIOR
2000 W
60' TEMPORIZADOR

INTERNAL MEASUREMENTS  
L x W x H cm  
41x34,5x23



**JECE1233**

**Electric cooker**

230 V - 1.400 W

- Heating plate: 1.400 W - Ø 185 mm.
- Adjustable thermostat of temperature.
- Pilot light.
- Great resistance epoxy paint body.
- Skid-resistance feet.
- Overheating protection.



||||| EAN 8421078038009 4 UNITS



**CE220**

**Electric cooker**

230 V - Máx. 2.250 W

- Great resistance epoxy paint body.
- 2 heating plates:
  - 750 W - Ø 157 mm.
  - 1.500 W - Ø 187 mm.
- 2 adjustable thermostats of temperature.
- Pilot lights.
- Overheating protection.



||||| EAN 8421078032632 3 UNITS



**V531**

**Vitroceraamic electric cooker**

230 V - 1.200 W

- Stainless steel housing.
- 1 vitroceraamic heating plate: 1.200 W. - Ø 180 mm.
- Adjustable thermostat of temperature.
- Pilot light.
- Extra-thin design.
- Overheating protection.



||||| EAN 8421078029571 4 UNITS



**V532**

**Vitroceraamic electric cooker**

230 V - Máx. 2.400 W

- Stainless steel housing.
- 2 vitroceraamic heating plates: 2 x 1.200 W. - Ø 180 mm.
- Adjustable thermostats of temperature.
- Pilot lights.
- Extra-thin design.
- Overheating protection.



||||| EAN 8421078029595 3 UNITS



JEVI1470



## Double induction electric cooker with grill plate

230 V - 2.800 W

- 2x 160mm induction heating plates.
- **Total power: 2.800 w**
  - Left plate power: 1.500 w
  - Right plate power: 1.300 w
- 4 mm glass surface.
- Removable non-stick tray/grill with extra large cooking area.
- Anti-splash metal lid.
- Independent buttons and knobs: On / off.
- Rotary power selectors.
- Security lock.
- Timer 99 minutes.
- Indicator lights.
- Maximum temperature 230°
- Overheating protection.
- 2 Led Displays.
- Easy to clean.



JEVI1470

EAN 8421078038115

1 UNIT



**JEVI1460**



**Induction electric cooker**

230 V - 3.500 W

- 2 induction heating plates.
- Operating diameter of 185 mm.
- Touch control.
- On / off.
- Temperature selector.
- Security lock.
- Timer 240 minutes.
- Indicator lights.
- Temperature range: 60° - 240°
- Overheating protection.
- 2 Led Displays.
- 4 mm glass surface.
- Easy to clean.
- Left plate power: 2.000 W
- Right plate power: 1.500 W



**4mm** SUPERFICIE VIDRIO TEMPLADO **PROTECCIÓN** SOBRECALENTAMIENTO **240'** TEMPORIZADOR



**JEVI1460**

||| EAN 8421078036920

📦 2 UNITS

**VIN145**



**Induction electric cooker**

230 V - 2.100 W

- 1 induction heating plate.
- 4 mm glass surface.
- 8 programmed functions.
- Tactile switches:
- On / off.
- Function selector.
- Preset timer.
- Pause.
- Power and temperature slide regulator.
- Operating diameters: from 120mm to 260 mm.
- LED display.
- Indicator lights.
- Overheating protection.



**4mm** SUPERFICIE VIDRIO TEMPLADO **PROTECCIÓN** SOBRECALENTAMIENTO **INDUCCIÓN** **CONTROLLES TÁCTILES** **FUNCIONES PROGRAMAD.** **2100 W**

**VIN145**

||| EAN 8421078032878

📦 3 UNITS

## Vitroc ceramic electric cooker

230 V - 2.000 W

- Metallic housing.
- 1 vitroc ceramic heating plate: 2.000 W - Ø 180 mm.
- Adjustable thermostat of temperature.
- Pilot light.
- Overheating protection.



V139 - PRATA

||||| EAN 8421078033547

📦 4 UNITS



V140 - AZUL

||||| EAN 8421078031475

📦 4 UNITS



**PROTECCIÓN SOBRECALENTAMIENTO**

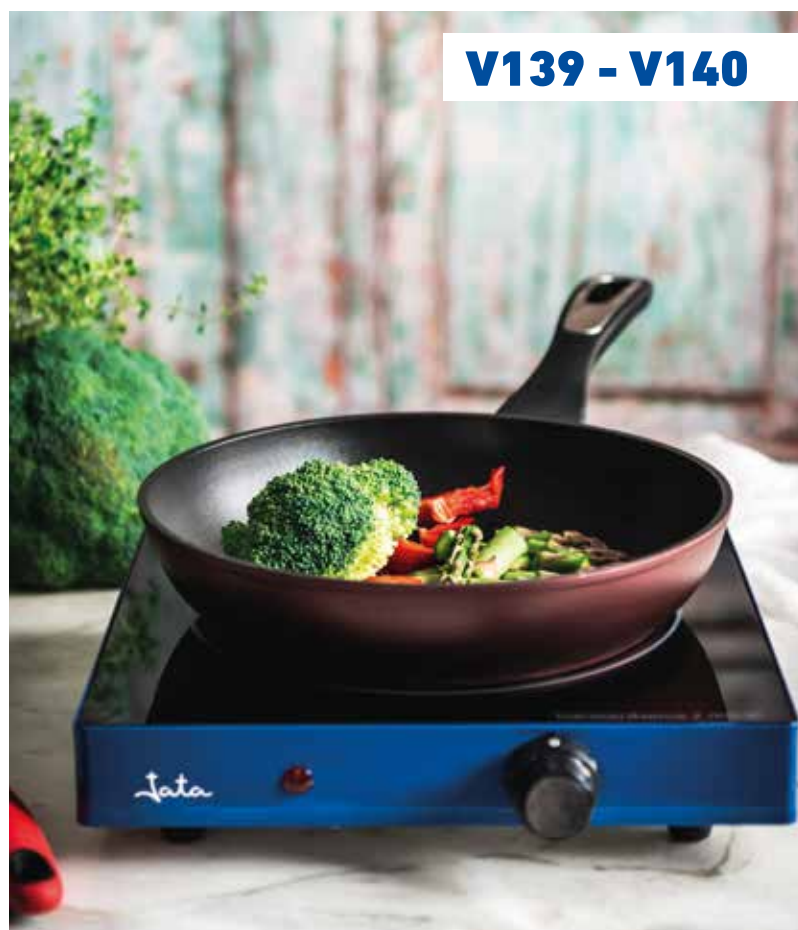

V139 - V140

## Vitroc ceramic electric cooker

230 V - 2.400 W

- Metallic housing.
- 2 vitroc ceramic heating plates: 2 x 1.200 W - Ø 165 mm.
- Pilot lights.
- 2 adjustable thermostats of temperature.
- Overheating protection.



V141 - PRATA

||||| EAN 8421078035367

📦 3 UNITS



V142 - AZUL

||||| EAN 8421078032601

📦 3 UNITS



**PROTECCIÓN SOBRECALENTAMIENTO**

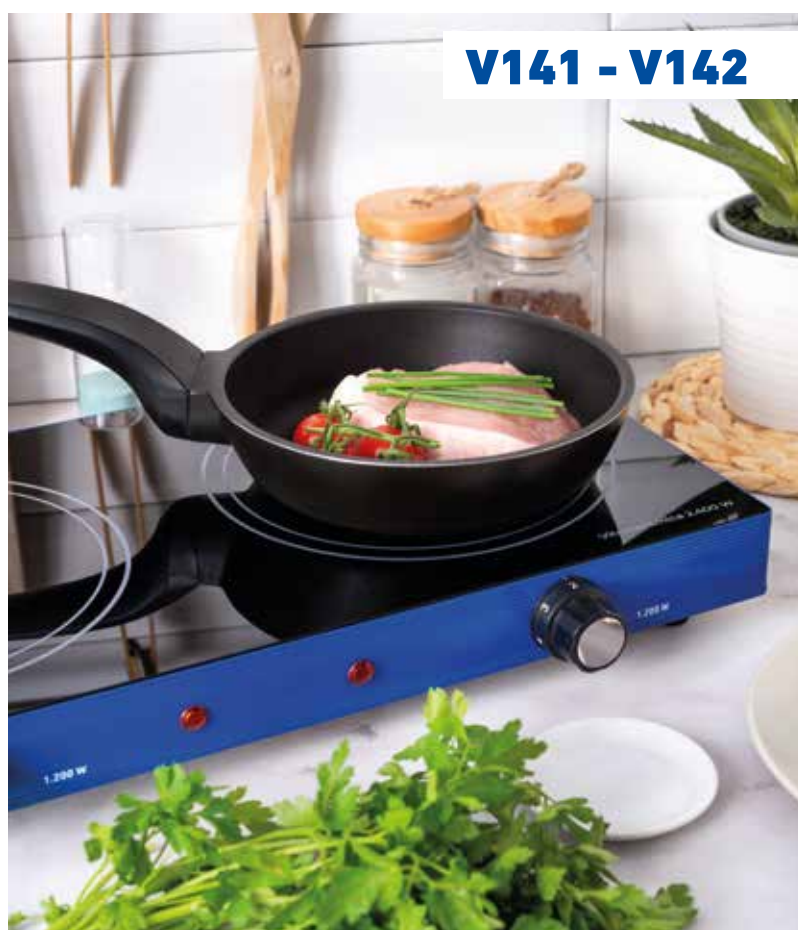

V141 - V142



### JECG2701 / JECG2721

## Gas cooker

- Portable gas cooker.
- 1 burner.
- Great resistance epoxy paint body.
- Grille.
- Specific standards for gas.
- Suitable for liquefied gases propane and butane.
- Removable protector lid.
- Use the appliance only outdoors.



TAPA PROTECTORA  
**EXTRAIBLE**



PARA  
**PROPANO  
Y BUTANO**

#### JECG2701

||||| EAN 8421078037019

3 UNITS

#### JECG2721

||||| EAN 8421078039099

3 UNITS

### JECG2702

## Gas cooker

- Portable gas cooker.
- 2 burners.
- Great resistance epoxy paint body.
- Removable protector lid.
- Grille.
- Suitable for all liquid gas.
- Specific standards for gas.



TAPA PROTECTORA  
**EXTRAIBLE**



PARA  
**PROPANO  
Y BUTANO**

||||| EAN 8421078037026

3 UNITS



### JECG2703

## Gas cooker

- Portable gas cooker.
- 3 burners.
- Great resistance epoxy paint body.
- Removable protector lid.
- Grille.
- Suitable for liquefied gases propane and butane.
- Specific standards for gas.



TAPA PROTECTORA  
**EXTRAIBLE**



PARA  
**PROPANO  
Y BUTANO**

||||| EAN 8421078037033

3 UNITS





## Food steamer

230 V - 400 W

- Healthy cooking.
- Remain all the properties and vitamins.
- Keep the natural taste of the food.
- Timer 60 minutes.
- Automatic switch off.
- Water tank capacity 500 ml.
- 2 transparent piled up bowls. Total capacity: 3,5 l.
- Grids with holders for egg boiling.
- Rice or sauce bowl included.
- Indicator light.
- Transparent lid.



CV200

||||| EAN 8421078029472

📦 6 UNITS



CV5020

||||| EAN 8421078035282

📦 6 UNITS



CV200 / CV5020

## CV623

## Food steamer

230 V - 800 W

- Healthy cooking.
- Remain all the properties and vitamins.
- Keep the natural taste of the food.
- BPA free.
- Timer 60 minutes.
- Automatic switch off.
- Glass cover.
- 2 transparent piled up bowls. Capacity: 6,8 l.
- Stainless steel removable grids.
- Grids with holders for egg boiling.
- Water tank capacity 1,2 l.
- Continuous refill.
- Water level indicator.
- Rice or sauce bowl included.



||||| EAN 8421078035213

📦 2 UNITS



Download our **steam cooking recipes** in:

[www.jata.es](http://www.jata.es)



**JEOL2145**



**Digital slow cooker**

230 V - 210 W

- Slow cooker to prepare all kinds of dishes.
- Capacity 5 l.
- Terracotta oval ceramic bowl. Healthy and traditional cuisine.
- Timer 20 hours.
- Warming function.
- Multifunction LCD information display.
- Suitable bowl for use in the oven max 250°
- Removable recipient for easy cleaning, suitable for dishwasher.
- 3 heat levels: high, low and warming.
- Glass cover.
- Side handles.



*Download recipes*

**TERRACOTA**  
SLOW COOK

**JEOL2145**

||||| EAN 8421078036548

📦 2 UNITS



**JEOL2135**



**Slow cooker**

230 V - 180 W

- Slow cooker to prepare all kinds of dishes.
- Capacity 3,5 l.
- Ceramic oval bowl in Terracotta. Healthy and traditional cuisine.
- Suitable bowl for use in the oven max 250°
- Removable recipient for easy cleaning, suitable for dishwasher.
- 3 heat levels: high, low and warming.
- Glass cover.
- Side handles.
- Light pilot.

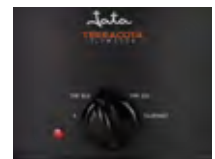

**TERRACOTA**  
SLOW COOK

**JEOL2135**

||||| EAN 8421078036531

📦 2 UNITS



# Range of **LARGE CAPACITY** AIR FRYERS



## AR393

### Electric rice cooker

230 V - 400 W

- Capacity 1 l.
- Tempered safety glass lid.
- Program selector: cooking / warm.
- Automatic change from cooking to warm function.
- Cooking and warm indicator lights.
- Removable aluminum tank with non-stick coating.
- Overheating protection.
- Steam out valve.
- Easy to clean
- Transport handle
- Spatula and measuring cup included.



||||| EAN 8421078035480

📦 4 UNITS



## AR394

### Electric rice cooker

230 V - 400 W

- Capacity 1 l.
- Tempered safety glass lid.
- Program selector: cooking / warm.
- Automatic change from cooking to warm function.
- Cooking and warm indicator lights.
- Removable aluminum tank with non-stick coating.
- Overheating protection.
- Steam out valve.
- Easy to clean
- On / Off switch.
- Transport handle
- Spatula and measuring cup included.



||||| EAN 8421078035497

📦 2 UNITS





**JEYG2266**



**Yogurt maker**

230 V - 20 W

- 7 glass pots with lid (180 ml)
- suitable for dishwasher.
- 1,26 L Capacity
- BPA free.
- Non-slip feet.
- Stainless steel base.
- ON/OFF switch.
- Power indicator light.
- Length of the cord 0,80 m.
- Measures: 24 x 12,5 cm

**INCLUDES  
7 GLASSES**



**3 spare glasses  
for yogurt maker**



**JREC2266**

EAN 8421078037378

15 UNITS

EAN 8421078037118

4 UNITS

1,26L CAPACIDAD LIBRE DE BPA

**YOGURT MAKERS**

**JECR1000**



**Crepe maker**

230 V - 1.200 W

- Large 30 cm diameter surface.
- Includes spreader and crepe spatula.
- PFOA-free non-stick coating.
- Adjustable temperature thermostat.
- 2 pilot lights ON / ready.
- Non-slip feet.
- Upright storage.
- Cord storage.
- Overheating safety device.



TERMOSTATO REGULABLE GRAN SUPERFICIE Ø30 cm 1200 W 2 ACCESORIOS INCLUIDOS LIBRE DE PFOA

**JECR1000**

EAN 8421078038139

6 UNITS

## Popcorn maker

230 V - 1.200 W

- Popcorn without oil in 3 minutes.
- 60 g. corn capacity.
- On / off switch.
- Anti-sliding base.
- Dispenser.
- Easy cleaning.



**PAL97**

||||| EAN 8421078035565

6 UNITS



**PAL97**

**POPCORN MACHINE**

## PC123N

### Chopper

230 V - Máx.650 W

- 1, 2, 3 steps chopping.
- Suitable to chop all kind of food.
- Great capacity.
- On / off lid pusher.
- Safety switch.
- Stainless steel blade.
- Detachable for easy cleaning.



||||| EAN 8421078033394

6 UNITS



## JEPC1250

### Chopper

230 V - 400 W

- Suitable for chopping all kinds of food, even ice.
- Glass bowl with 1.5 L capacity.
- Start button with 2 speeds.
- Safety switch.
- 4 stainless steel blades.
- Detachable for easy cleaning.
- Anti-sliding base.



||||| EAN 8421078036883

4 UNITS





**CF1053**

**PRO SERIES**

## Metallic food slicer

230 V - 200 W

- Metal housing.
- Detachable "Stonite" non-stick blade of 190 mm.
- "Stonite" non-stick coating free of PFOA.
- Switch 3 positions: continuous functioning, pulse and off.
- Maximum cut power.
- Detachable sliding platform.
- Thickness adjustment from 1 to 22 mm.
- Skid-resistance feet.
- Detachable for easy cleaning.



LIBRE DE PFOA



||||| EAN 8421078035053

2 UNITS

**JECF1200**

**SPRING NOVELTY**



## Food slicer

230 V - 200 W

- Detachable stainless steel blade of 190 mm.
- Security system against unintentional use.
- Carriage with hand protection system.
- Thickness adjustment from 0 to 15 mm.
- Anti-sliding base.
- Detachable and easy cleaning.



**JECF1200**

||||| EAN 8421078038580

2 UNITS





# Food slicer

230 V - 100 W

- Detachable stainless steel blade of 170 mm.
- Anti-involuntary use security system.
- Thickness adjustment from 0 to 15 mm.
- Folding housing.
- Anti-sliding base.
- Detachable and easy cleaning.

## JECF0300

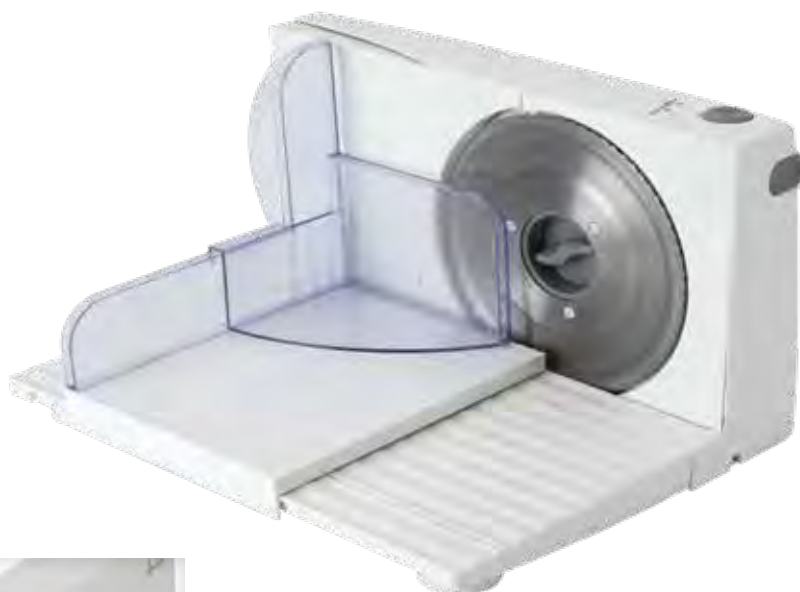

JECF0300

||||| EAN 8421078036234

📦 4 UNITS

# Food slicer

230 V - 120 W

- Stainless steel cutting area.
- Metalized housing.
- Detachable steel blade.
- Involuntary use double security system.
- Thickness adjustment from 0 to 15 mm.
- Folding housing.
- Cord storage.
- Anti-sliding base.
- Detachable and easy cleaning.

SPRING  
NOVELTY

## JECF1820

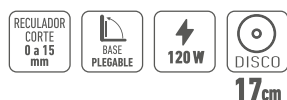

JECF1820

||||| EAN 8421078038641

📦 4 UNITS



**EV1026**

**Vacuum sealer**

230 V - 130 W

**PRO SERIES**

- Vacuum pressure: max. 0,85 bar.
- Pump capacity: 12 l. min.
- Only seal function.
- Soft seal function to protect delicate food from crushing.
- **Sealing time:**
  - 6 seconds dry food
  - 9 seconds sauces.
- Marinate function.
- Vacuum bowl function.

- **Includes:**
  - Hermetic bowl with vacuum date indicator. Capacity 1 l. Suitable for the dishwasher and microwave. Measures: 16 x 16 x 6 cm.
  - Vacuum tube.
  - 2 wine stoppers.
  - 1 roll of 22 x 3 m.
  - 1 roll of 28 x 3 m.
  - Cord storage.

**INCLUDES**  
**Hermetic bowl 1 l.**  
**2 wine stoppers**  
**1 roll of 22 x 3 m**  
**1 roll of 28 x 3 m**

|                          |                         |                |                           |       |
|--------------------------|-------------------------|----------------|---------------------------|-------|
| APTO PARA BOLSAS/ ROLLOS | 12L/min CAPACIDAD BOMBA | TUBO ASPIRADOR | 0,85 bar POTENCIA SUCCION | 130 W |
|--------------------------|-------------------------|----------------|---------------------------|-------|

||||| EAN 8421078029656

2 UNITS

**JEEV2210**

**Vacuum sealer**

230 V - 90 W

- Multiply per 5 the food life and keep unaffected the nutritional properties.
- Vacuum pressure: max. 0,60 bar.
- Pump capacity: 4,5 l. min.
- "Only seal" function. Suitable for using with roll.
- Sealing time 7-10 seconds.
- Vacuum bowl function. Vacuum tube included.
- Size: 37,3 x 7,7 x 5,6 cm
- Suitable for bags of 30 cm width max.
- Elegant design, light and compact.
- Magnets to hold on the fridge.
- Cutting blade for plastic rolls.
- Operating light indicators.
- Removable 1.4 m. cable for easy storage.



**BLACK STAINLESS STEEL SERIES**

|                           |                  |      |                          |                          |                |
|---------------------------|------------------|------|--------------------------|--------------------------|----------------|
| 0,60 bar POTENCIA SUCCION | EXTRAIBLE 1,4 m. | 90 W | APTO PARA BOLSAS/ ROLLOS | 4,5L/min CAPACIDAD BOMBA | TUBO ASPIRADOR |
|---------------------------|------------------|------|--------------------------|--------------------------|----------------|

||||| EAN 8421078037187

6 UNITS

**INCLUDES 10 GIFT BAGS**



Container non included

**EV109**

**Vacuum sealer**

230 V - 85 W

- Vacuum pressure: max. 0,60 bar.
- Pump capacity: 4,5 l. min.
- "Only seal" function. Suitable for using with roll.
- Sealing time 10 seconds.
- Vacuum bowl function. Vacuum tube included.
- Suitable for bags of 28 cm wide.
- Elegant design, light and compact.

|                          |                          |                |                           |      |
|--------------------------|--------------------------|----------------|---------------------------|------|
| APTO PARA BOLSAS/ ROLLOS | 4,5L/min CAPACIDAD BOMBA | TUBO ASPIRADOR | 0,60 bar POTENCIA SUCCION | 85 W |
|--------------------------|--------------------------|----------------|---------------------------|------|

||||| EAN 8421078033943

6 UNITS

## Vacuum sealer

230 V - 120 W

- Multiply per 5 the food life and keep unaffected the nutritional properties.
- Vacuum pressure: max. 0,70 bar.
- Pump capacity: 4 l. min.
- "Only seal" function. Suitable for using with roll.
- Sealing time 6 seconds.
- Specific external vacuum function. Vacuum tube included.
- Size: 37,2 x 11,6 x 5,7 cm.
- Suitable for bags of 30 cm width max.
- 5 bags included, 20 x 25 cm.
- Cord storage.
- Cutting blade for plastic rolls.
- LED operating indicators.
- Overheating safety device.



**INCLUDES  
5 BAGS  
FOR FREE**



**JEEV2240**

||||| EAN 8421078038573

📦 4 UNITS



**2**  
ROLLS PER  
BOX



📦x2

**R22x6 - R28x6**

### Rolls

REPLACEMENTS

- Original bag spare part suitable for JATA vacuum sealer

22 cm

**R22x6**

||||| EAN 8421078029915

📦 15 UNITS

28 cm

**R28x6**

||||| EAN 8421078029939

📦 15 UNITS

**50**  
BOLSAS  
SACOS  
BAGS



📦x50

**B22x30 - B28x40**

### Bags

REPLACEMENTS

- Original bag spare part suitable for JATA vacuum sealer

22 x 30 cm

**B22x30**

||||| EAN 8421078029953

📦 15 UNITS

28 x 40 cm

**B28x40**

||||| EAN 8421078029977

📦 15 UNITS



All our **recipes** and the **latest product catalogs** are available to download at:



[www.jata.es](http://www.jata.es)

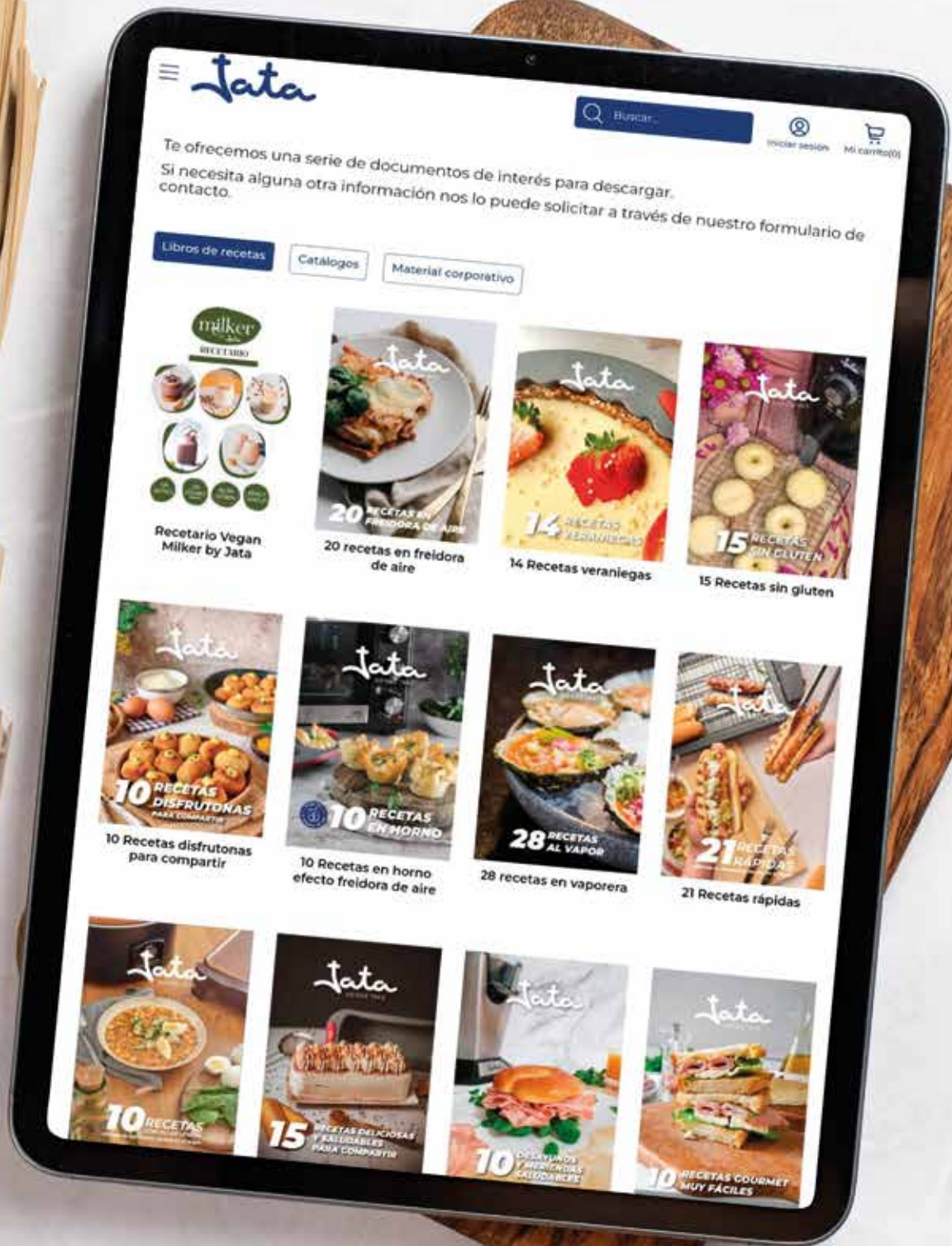





# NON ELECTRIC KITCHENWARE

**JH01**



 Control de cambio de filtros integrado

 **AHORRA**  
720 BOTELLAS DE PLÁSTICO  
PROTEGE EL MEDIO AMBIENTE

**SIZE L x W x H**  
26 x 8,5 x 26cm

**Water filter jar**  
2,5 L

- Exclusive Ionic Jata filter.
- Improve the quality and taste of water remaining the essentials minerals.
- Reduces chlorine by up to 80%.
- Reduces limescale by up to 95%.
- Reduces cooper by up to 50%.
- Adjust the pH value to 7-8.
- 150-180 L. filtered water or 30-45 days.
- Manual indicator to control the filter.
- Suitable for placing in the door of the fridge.
- Anti-sliding base.
- Ergonomic handle



**JH01**  
EAN 8436017654080  
6 UNITS

 **FILTRO IÓNICO**  **LIBRE DE BPA**  **ANTI DESLIZANTE**

 -95% CAL  -80% CLORO  -50% COBRE  pH 7-8  2,5L  1,5L  
Capacidad total Capacidad agua filtrada

**HJAR1001**



**CLEAN QUALITY WATER**  
INCLUDES 6 FILTERS  
FOR ALMOST AN ENTIRE YEAR

 Control de cambio de filtros integrado

 **AHORRA**  
720 BOTELLAS DE PLÁSTICO  
PROTEGE EL MEDIO AMBIENTE

**SIZE L x W x H**  
26 x 8,5 x 26cm

**Water filter jar**  
2,5 L + 6 FILTER

- Exclusive JATA HOGAR ionic filter.
- Improve the quality and taste of water remaining the essentials minerals.
- Reduces chlorine by up to 80%.
- Reduces limescale by up to 95%.
- Reduces cooper by up to 50%.
- Adjust the pH value to 7-8.
- 150-180 L. filtered water or 30-45 days.
- Manual indicator to control the filter.
- Suitable for placing in the door of the fridge.
- Anti-sliding base.
- Ergonomic handle



**DISPLAY BOX MOCKUP PRESENTATION SUGGESTION**  
580 x 390 x 130 mm

**HJAR1001**  
EAN 8436584382461  
6 UNITS

 **FILTRO IÓNICO**  **LIBRE DE BPA**

 -95% CAL  -80% CLORO  -50% COBRE  pH 7-8  2,5L  1,5L  
Capacidad total Tamaño apto nevera



# Water filter jar

3,5 L + 6 FILTER

- Manual filter control indicator.
- Ionic filter.
- Improve the quality and taste of water remaining the essentials minerals.
- Reduces chlorine by up to 80%.
- Reduces limescale by up to 95%.
- Reduces cooper by up to 50%.
- Adjust the pH value to 7-8.
- 150-180 L. filtered water or 30-45 days.
- Manual indicator to control the filter.
- Suitable for placing in the door of the fridge.
- Anti-sliding base.
- Flip-top lid.
- Ergonomic handle
- Water jug size: : 256 x 119 x 279



**HJAR1003**



Control de cambio de filtros integrado



**AHORRA**  
720 BOTELLAS DE PLÁSTICO  
PROTEGE EL MEDIO AMBIENTE

**HJAR1003**

||||| EAN 8436584382478

📦 6 UNITS



LIBRE DE BPA



SIZE L x W x H

25,6 x 11,9 x 27,9 cm

**RE123X4**

## Pack of 4 ionic filters

FOR WATER FILTER JAR

- Exclusive Ionic Jata filters.
- Improve the quality and taste of water remaining the essentials minerals.



LIBRE DE BPA

||||| EAN 8436017654523

📦 6 UNITS



55K



12 UNITS  
DISPLAY BOX  
18,8 x 32 x 24 cm

3,5 x 14,5 x 3,5 cm

Baggage scale  
BATTERY FREE



- "U-Power": automatic energy generation.
- "LCD" screen.
- Net weight function.
- Kg/lb conversion switch.
- Automatic switch off.
- Overweight indicator.



Generation of energy by movement



55K

EAN 8436017659597

12 UNITS



HBAL1204



22,5 x 30,5 x 1,5 cm

Electronic kitchen scale  
20 KG USB WITHOUT BATTERIES

- Rechargeable battery: 2 hours full charge for using 6 months.
- USB cable included.
- Big tempered glass surface: 30 x 22,5 cm.
- High electronic accuracy.
- Large "LCD" display.
- Net weight function.
- Lock weighing function for large volumes.
- Kg / lb conversion function.
- Optional wall-mount.
- Automatic switch off.
- Low battery indicator.
- Overload indicator.

HBAL1204

EAN 8436584382225

6 UNITS



USB cable included.





## Smart nutritional electronic scale

### NUTRICIONAL

- Weighs and analyses 7 nutritional values: Calories, Protein, Fat, Carbohydrates, Fiber, Vitamins and Mineral.
- Wireless connection compatible with iOS\* and Android devices. Free "AIFRESH" application.
- Nutritional information on more than 10,000 foods and ingredients.
- Anti-fingerprint stainless steel surface.
- High electronic accuracy.
- Automatic switch off.
- Overweight indicator.
- Low battery indicator.
- Net weight function.
- G / oz / lb:oz. conversion function.
- Optional wall-mount.
- Works with 2 "AAA" batteries of 1,5 V (not included).



6 UNITS  
DISPLAY BOX  
17 x 19 x 22,5 cm

HBAL1300

||||| EAN 8436584384489

📦 6 UNITS

📦 14 x 20,5 x 1,5 cm



Aplicación Gratuita  
"AiFresh"



INFORMACIÓN NUTRICIONAL  
SOBRE MÁS DE 10.000  
ALIMENTOS E INGREDIENTES



Conexión  
Inalámbrica



**720 / HBL0310**

5 mm surface sustainably produced pressed bamboo.



- 
- 
- 
- 
- 
- 
- 
- 

18,3 x 22,5 x 1,7 cm

**Electronic kitchen scale**

**Bamboo**

15 Kg

- 5 mm bamboo thickness.
- High electronic accuracy.
- Back light "LCD" display.
- Clock.
- Net weight function.
- Timer function.
- Conversion function: g / Kg / oz / lb.oz. / fl.oz.
- Low battery indicator.
- Overload indicator.
- Works with 2 "AAA" batteries of 1,5 V (not included).



6 UNITS  
DISPLAY BOX  
20 x 20 x 23,8 cm



**720**

||||| EAN 8436017659580

6 UNITS

**HBL0310**

||||| EAN 8436584381372

6 UNITS

**719 / HBL0300**



- 
- 
- 
- 
- 
- 
- 
- 

18,3 x 22,5 x 1,7 cm

**Electronic kitchen scale**

15 Kg

- Stainless steel surface.
- High electronic accuracy.
- Back light "LCD" display.
- Clock.
- Net weight function.
- Timer function.
- Conversion function: g / Kg / oz / lb / fl.oz.
- Low battery indicator.
- Overload indicator.
- Works with 2 "AAA" batteries of 1,5 V (not included).



6 UNITS  
DISPLAY BOX  
20 x 20 x 23,8 cm



**719**

||||| EAN 8436017659351

6 UNITS

**HBL0300**

||||| EAN 8436584381365

6 UNITS

## Electronic kitchen scale

BATTERY FREE - 5 Kg



- Battery free technology.
- "U-Power": energy generation by rotation.
- Informs: Weight - Water volume - Milk volume.
- Tempered safety glass base.
- Touch sensor knob. Net weight function.
- "LCD" display. 4 digits.
- Automatic switch off.
- G / oz / lb:oz / ml conversion switch.
- Overweight indicator.



Rotational power generation



775

||| EAN 8436017659887

📦 6 UNITS

📦 19 x 24,5 x 3,8 cm



775

## Electronic kitchen scale

5 Kg

- LED display.
- Transparent bowl BPA free. Capacity 1 L.
- Option of use with different containers, according to weighing needs.
- Net weight function.
- Low battery indicator.
- Overload indicator.
- G / ml / oz.. conversion function.
- Automatic switch off.
- Works with 2 "AAA" batteries of 1,5 V (not included).



HBAL1709

||| EAN 8436584384496

📦 6 UNITS

📦 17 x 21,5 x 8,5 cm



HBAL1709



DIETARY 

**SPECIAL FOR DIABETICS AND CELIACS**

762

## Electronic kitchen scale

14 FOODS - 5 Kg

- Analyzes calories and carbohydrates of 14 foods.
- Tempered safety glass base.
- High electronic accuracy.
- Touch sensor knobs.
- Back light "LCD" display.
- Automatic switch off.
- Overweight indicator.
- Low battery indicator.
- Net weight function.
- G / oz / ml conversion function.
- Works with 2 CR2032 long life "lithium" batteries (included).
- **SPECIAL FOR DIABETICS AND CELIACS**

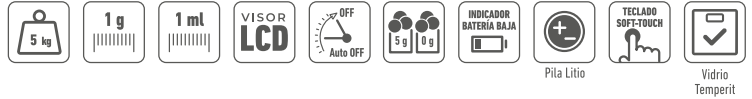

 15 x 22 x 1,5 cm

 EAN 8436017659078

 8 UNITS

**HBAL1775**



## Electronic kitchen scale WITHOUT BATTERIES

- High weighing accuracy.
- Charge indicator light.
- Rear magnet to place on the fridge.
- Backlight LCD display.
- Acoustic ON touch button.
- Low battery indicator.
- Overload indicator.
- Net weight function.
- Timer up to 99 min and 60 seconds
- G / oz / oml. conversion function.
- Automatic switch off.
- USB cord included.



**HBAL1775**

 EAN 8436584383918

 8 UNITS

 11,5 x 18 cm



**HBAL1774**

**High precision scale**

- Capacity 100 g.
- **GRADUATION 0,01 g.**
- Stainless steel surface 6,5 x 7 cm.
- Backlight LCD display.
- ON button.
- Calibration function.
- Lock weighing function.
- Low battery indicator.
- Automatic power off in 65 seconds.+
- Net weight function.
- Ct / dwt / ozt / g / oz /gn conversion function.
- Works with 2 "AAA" batteries of 1,5 V (not included).



7,5 x 11 cm x 1,5 cm

EAN 8436584383680

12 UNITS



**DOUBLE SEALED BLISTER**



**LID AND PROTECTIVE COVER**



**HBAL1207**

**Electronic kitchen scale**

- Capacity 5 Kg.
- Graduation 1 g.
- High electronic accuracy.
- Touch sensor knobs.
- Net weight function.
- "LCD" display.
- G / Kg / lb:oz / fl'oz / ml. conversion function.
- Automatic switch off.
- Optional wall-mount.
- Anti-sliding base.
- Low battery indicator.
- Overload indicator.
- Works with 2 "AAA" batteries of 1,5 V (not included).



15 x 21,5 x 4,5 cm

EAN 8436584382492

6 UNITS

**721 / HBAL1220**

**Electronic kitchen scale**

5 Kg

- Informs: Weight - Water volume. - Milk volume.
- Stainless steel platform.
- High electronic accuracy.
- Back light "LCD" display.
- Net weight function.
- Conversion function: g / ml / oz:lb.
- Low battery indicator.
- Overload indicator.
- Optional wall-mount.
- Works with 3 "AAA" batteries of 1,5 V (not included).



721

EAN 8436017659993

8 UNITS

HBAL1220

EAN 8436584381679

8 UNITS



Big size display

14,5 x 22 x 3,7 cm

**HBAL1254**

**AUTUMN  
NOVELTY**



## Electronic kitchen scale

### DOUBLE PLATFORM

- Stainless steel with anti-fingerprint coating.
- Large LED display.
- Net weight function.
- Automatic switch off.
- Low battery indicator.
- Overload indicator.
- High electronic accuracy.
- Measures: 23 x 16,5 x 3,2 cm
- **Large platform:**
  - Maximum capacity 5 Kg.
  - Graduation 1 g.
  - g / oz / Kg / lb:oz / ml. / fl:oz conversion function.
- **Small platform:**
  - Maximum capacity 500 g.
  - Graduation 0,1 g.
  - g / oz / ml. / fl:oz conversion function.

**HBAL1254**

||||| EAN 8436584385011

📦 6 UNITS

📦 23 x 16,5 x 3,2 cm



**6 UNITS  
DISPLAY BOX**  
23 x 19 x 24 cm



**773 / HBAL0370**

**High precision scale**

FROM 0,3 gr TO 3 Kg

- Stainless steel surface 13 x 10 cm.
- High weighing accuracy.
- Backlight LCD display.
- On pusher.
- Calibration function.
- Lock weighing function.
- Automatic switch off.
- Net weight function.
- G / oz / ozt / ct / dwt conversion function.
- 2 protective covers with tray function.
- Works with 2 "AAA" batteries of 1,5 V (not included).



2 protective covers with tray function



**773**

||||| EAN 8436017659061

📦 8 UNITS

📦 10,5 x 13 x 2 cm

**HBAL0370**

||||| EAN 8436584381761

📦 8 UNITS

📦 10,5 x 13 x 2 cm



6 UNITS DISPLAY BOX  
30 x 24 x 29 cm



**HBAL1208**

**Electronic kitchen scale**

15 Kg USB / WITHOUT BATTERIES

- Graduation 1 g.
- Stainless steel surface.
- No batteries. USB cable included.
- High electronic accuracy.
- Low battery indicator.
- Overload indicator.
- Clock.
- Timer 200 min.
- Conversion function: g / Kg / oz / lb:oz / fl.oz
- Back light "LCD" display.
- Net weight function.
- Rechargeable battery: 2 hours full charge for using 4 months.
- Optional wall-mount.
- Automatic switch off.



📦 20,5 x 19,5 x 1,5 cm

||||| EAN 8436584382607

📦 6 UNITS

**HBAL1202**

**Electronic kitchen scale**

WITH LID 5 Kg DESIGN

- Stainless steel surface.
- High weighing accuracy.
- Large "LCD" display.
- Touch sensor knobs.
- Net weight function.
- G / lb:oz / fl'oz / ml. conversion function.
- Automatic switch off.
- Low battery indicator.
- Overload indicator.
- Protective cover with tray function.
- Works with 1 CR2032 long life lithium battery (included).



📦 14 x 17,5 x 2,7 cm

||||| EAN 8436584381839

📦 8 UNITS





**731K**

**732K**



**6 UNITS  
DISPLAY BOX**  
16 x 15,8 x 21,8 cm

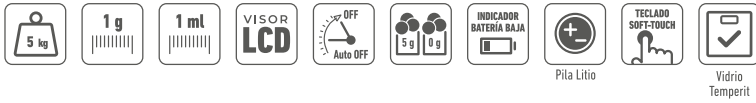

## 731K / 732K

### Electronic scale

5 Kg

- Informs: Weight - Water volume - Milk volume.
- High electronic accuracy.
- Touch sensor knobs.
- Net weight function.
- Tempered safety glass surface.
- "LCD" display, 4 digits.
- Kg / g / lb:oz / ml conversion function.
- Automatic switch off.
- Low battery indicator.
- Overload indicator.
- Works with 1 CR2032 long life lithium battery (included).



#### 731K

||||| EAN 8436584381044

📦 6 UNITS

📦 14 x 20 x 1,5 cm

#### 732K

||||| EAN 8436584381037

📦 6 UNITS

📦 14 x 20 x 1,5 cm

## HBAL0350 / HBAL1203

### Electronic kitchen scale

5 Kg

- High electronic accuracy.
- Touch sensor knobs.
- Net weight function.
- "LCD" display.
- G / kg / lb/ oz. conversion function.
- Automatic switch off.
- Optional wall-mount.
- Low battery indicator.
- Overload indicator.
- Works with 2 "AAA" batteries of 1,5 V (not included).



**HBAL0350**



**HBAL1203**



**6 UNITS  
DISPLAY BOX**  
18,5 x 16,5 x 21 cm



#### HBAL0350

||||| EAN 8436584381846

📦 12 UNITS

📦 17 x 19,5 x 1,8 cm

#### HBAL1203

||||| EAN 8436584381754

📦 12 UNITS

📦 17 x 19,5 x 1,8 cm

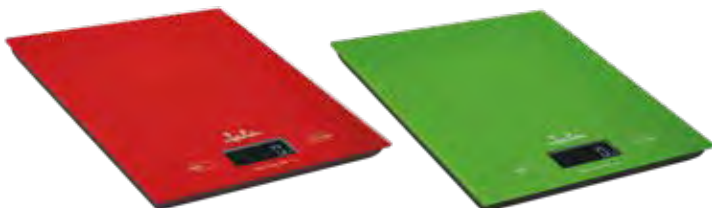

**729R**

**729V**



**6 UNITS  
DISPLAY BOX**  
21 x 19,5 x 20 cm



## 729R / 729V

### Electronic kitchen scale

5 Kg

- Informs: Weight - Water volume - Milk volume.
- High electronic accuracy.
- Touch sensor knobs.
- Net weight function.
- Tempered safety glass surface.
- "LCD" back light display, 4 digits.
- Kg / g / lb:oz / ml conversion function.
- Automatic switch off.
- Low battery indicator.
- Overload indicator.
- Works with 1x 3 V CR2032 battery (included).

#### 729R

||||| EAN 8436017659092

📦 6 UNITS

📦 18 x 20 x 2 cm

#### 729V

||||| EAN 8436017659108

📦 6 UNITS

📦 18 x 20 x 2 cm

**722 / 722P / 722CS**



## Electronic kitchen scale

ROUNDED

- Informs: Weight - Water volume - Milk volume.
- High electronic accuracy.
- Touch sensor knobs.
- Net weight function.
- Tempered safety glass surface.
- "LCD" back light display. 4 digits.
- G / lb / ml conversion function..
- Automatic switch off.
- Low battery indicator.
- Overload indicator.
- Works with 1x 3 V CR2032 battery (included).

 18 x 20 x 2 cm

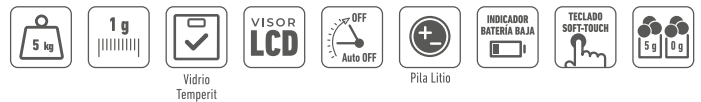

**MOD.722**  
8 UNITS  
DISPLAY BOX  
22,1 x 47,6 x 19 cm



**MOD.722CS**  
8 UNITS  
DISPLAY BOX  
21 x 18,5 x 23 cm

**722**

||||| EAN 8436017655865

 8 UNITS

AVAILABLE IN 4 COLORS



(2 units of each color)

**722P**

||||| EAN 8436017656619

 12 UNITS

AVAILABLE IN 4 COLORS



(3 units of each color)

**722CS**

||||| EAN 8436584380245

 8 UNITS

AVAILABLE IN 4 COLORS



(2 units of each color)

## HBAL7230



HBAL7230

||||| EAN 8436584382249

📦 8 UNITS

📦 19 x 19 x 2 cm

## Round electronic kitchen scale

TURQUOISE BLUE - 5 Kg

- Capacity 5 kg.
- Graduation 1 g.
- Informs: Weight - Water volume - Milk volume.
- High electronic accuracy.
- Touch sensor knobs.
- Net weight function.
- Tempered safety glass surface.
- "LCD" display, 4 digits.
- G / lb / ml conversion function.
- Automatic switch off.
- Low battery indicator.
- Overload indicator.
- Works with 1 CR2032 long life lithium battery (included).



6 UNITS  
DISPLAY BOX  
22 x 21 x 20 cm



## HBAL7240



HBAL7240

||||| EAN 8436584382256

📦 8 UNITS

📦 19 x 19 x 2 cm

## Round electronic kitchen scale DRAWINGS

5 Kg

- Capacity 5 Kg.
- Graduação 1 g.
- Informs: Weight - Water volume - Milk volume.
- High electronic accuracy.
- Touch sensor knobs.
- Net weight function.
- Tempered safety glass surface.
- "LCD" display, 4 digits.
- G / lb / ml conversion function.
- Automatic switch off.
- Low battery indicator.
- Overload indicator.
- Works with 1 CR2032 long life lithium battery (included).



6 UNITS  
DISPLAY BOX  
22 x 21 x 20 cm



Vidrio  
Temperit



610N

## Mechanical kitchen scale

COM RECIPIENTE - 3 Kg

- Ultra flat design and horizontal display.
- Easy reading dial.
- Bowl with handle suitable for solids and liquids. Capacity 1 L.
- Specially recommended for dietetic use.
- Net weight function.
- Minimum storage space.
- Suitable for alimentary use.



Easy reading dial



19,5 x 23 x 12,5 cm

EAN 8436017651928

6 UNITS



## Electronic kitchen scale

Bamboo

- 5 mm surface sustainably produced pressed bamboo.
- Capacity 5 kg.
- Graduation 1 g.
- High weighing accuracy.
- LCD display.
- Touch sensor knobs.
- Net weight function.
- G / kg / lb:oz / ml / fl:oz conversion function.
- Automatic switch off.
- Low battery indicator.
- Overload indicator.
- Works with 1 CR2032 long life lithium battery (included).



6 UNITS  
DISPLAY BOX  
20,5 x 16,5 x 19 cm

HBAL1110

EAN 8436584384687

6 UNITS

18.5 x 18.5 x 1.7 cm



HBAL1110

5 mm  
surface  
sustainably  
produced  
pressed  
bamboo.



**HCAF1135 / HCAF1160**



## Plunger frothing coffee maker teapot

- Made of borosilicate, polypropylene and stainless steel.
- Complies with FDA and LFGB regulations.
- BPA free.
- Resistant to high and low temperatures: from -20 °C to 120 °C
- 3-tier stainless steel mesh filter.
- Ideal for preparing your coffees, infusions and frothings.
- Cold touch handle.

**350 ml**

**HCAF1135**

||||| EAN 8436584385233

☐ 6 UNITS

**600 ml**

**HCAF1160**

||||| EAN 8436584385240

☐ 6 UNITS



**IDEAL FOR PREPARING YOUR COFFEES, INFUSIONS AND FROTHINGS**

RESISTENTE A 120 °C -20 °C

LIBRE DE BPA



**CAX1\_**

## Induction italian inox coffee maker

- Manufactured in stainless steel.
- Shine finishing.
- Solid handle.
- Suitable for all cookers, induction included.



**CAX104**

||||| EAN 8436017658163

📦 6 UNITS

Base diameter: 10 cm



**CAX106**

||||| EAN 8436017658170

📦 6 UNITS

Base diameter: 10 cm



**CAX110**

||||| EAN 8436017658187

📦 6 UNITS

Base diameter: 11 cm



**CAX112**

||||| EAN 8436017659436

📦 6 UNITS

Base diameter: 12 cm

*Odin*







**CCA\_**  
**Italian coffee maker**

- Inner shine finishing.
- Solid handle.
- Silicone ring.
- Aluminium body.

*Helena*



**CCA3**  
 EAN 8436017658583  
 12 UNITS



**CCA6**  
 EAN 8436017658590  
 12 UNITS



**CCA9**  
 EAN 8436017658606  
 12 UNITS



**CCA12**  
 EAN 8436017658613  
 6 UNITS



**CFI\_**  
**Full induction italian coffee maker**

- Full induction bottom.
- Inner shine finishing.
- Solid handle.
- Aluminium body.
- Silicone ring.
- Suitable for all cookers, induction included.

*Jaguar*



Full induction bottom



**CFI6**  
 EAN 8436017659825  
 6 UNITS  
 Base diameter: 10 cm



**CFI9**  
 EAN 8436017659832  
 6 UNITS  
 Base diameter: 11 cm



**CFI12**  
 EAN 8436017659849  
 6 UNITS  
 Base diameter: 12 cm



**HCAF20\_**  
**Induction italian coffee maker**

- Full induction bottom.
- Exterior painted oven-baked at 280 °C, high resistance, red enamelled.
- Solid handle, anti-burned design.
- Aluminium body.
- Silicone ring.
- Suitable for all cookers, induction included.

*Vulcano*



Full induction bottom



**HCAF2006**  
 EAN 8436584381907  
 6 UNITS  
 Base diameter: 10 cm



**HCAF2009**  
 EAN 8436584381914  
 6 UNITS  
 Base diameter: 10,8 cm



**HCAF2012**  
 EAN 8436584381921  
 6 UNITS  
 Base diameter: 11,7 cm



**AUTUMN NOVELTY**

**HCAF24\_**



## Induction italian coffee maker

- Full induction bottom.
- Exterior painted oven-baked at 280 °C.
- Solid handle. Special anti-burn design.
- Aluminium body.
- Silicone ring.
- Suitable for all cookers, induction included.

*Bistrea*



**HCAF2403**

||||| EAN 8436584384991

📦 6 UNITS

Base diameter: 9,80 cm



**HCAF2406**

||||| EAN 8436584384731

📦 6 UNITS

Base diameter: 10,05 cm



**HCAF2409**

||||| EAN 8436584384748

📦 6 UNITS

Base diameter: 10,15 cm



**HCAF2412**

||||| EAN 8436584384755

📦 6 UNITS

Base diameter: 10,8 cm



**HOLL22\_**



4 security systems

**Pressure cooker**

- High security.
- Pressure 100 kPa.
- Pressure control valve: Position 1: 100 kPa.
- Safety valve pressure: 130-170 kPa.
- Safety window pressure: 180-300 kPa.
- SUS304 stainless steel.
- Diameter 24 cm.
- 1,2 mm. thickness body.
- 5 mm. sandwich base.
- Suitable for all cookers, induction included.

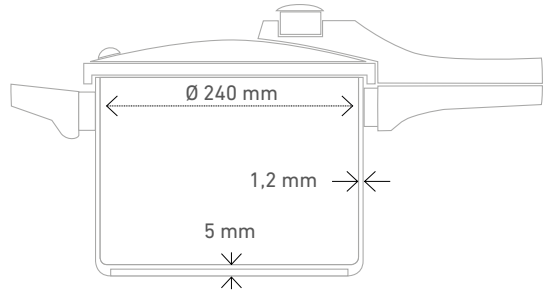

|                            |                            |                             |
|----------------------------|----------------------------|-----------------------------|
| <b>HOLL2226 - 6 liters</b> | <b>HOLL2228 - 8 liters</b> | <b>HOLL2230 - 10 liters</b> |
| EAN 8436584381860          | EAN 8436584381877          | EAN 8436584381884           |
| 📦 2 UNITS                  | 📦 2 UNITS                  | 📦 2 UNITS                   |

**OPC\_**



*Express*

**Classic pressure cooker EXPRESS**

- 3 security systems.
- Progressive closing system by rotary handle.
- SUS304 stainless steel.
- 1 mm. thickness body.
- 5 mm. sandwich base.
- Lateral handles.
- Suitable for all cookers, induction included.



3 security systems

|                        |                          |
|------------------------|--------------------------|
| <b>OPC4 - 4 liters</b> | <b>OPC6 - 6 liters</b>   |
| EAN 8436017657685      | EAN 8436017657692        |
| 📦 4 UNITS              | 📦 4 UNITS                |
| <b>Diameter: 20 cm</b> | <b>Diameter: 22 cm</b>   |
| <b>OPC8 - 8 liters</b> | <b>OPC10 - 10 liters</b> |
| EAN 8436017657715      | EAN 8436017657722        |
| 📦 2 UNITS              | 📦 2 UNITS                |
| <b>Diameter: 24 cm</b> | <b>Diameter: 26 cm</b>   |





OSR\_

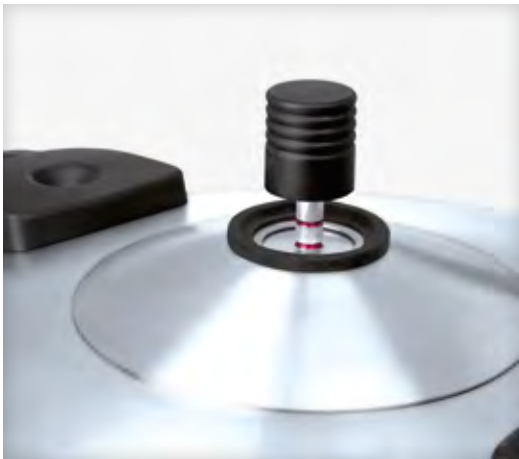

## Fast pressure cooker

- 4 security devices.
- Sealed pressure valve. No smell.
- Silent, safe and attractive design.
- Top security.
- Cooks one third faster than traditional pressure cookers.
- SUS304 stainless steel.
- Advantages of steam cooking pressure:
  - Fast: up to 70% reduction in cooking time.
  - Healthy: retains vitamins and minerals.
  - Energy savings.
- Silicone ring.
- Suitable for all cookers, induction included.

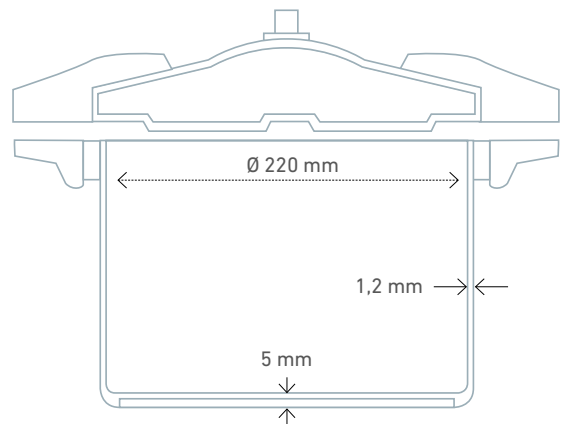

Video



**OSR4 - 4 liters**

||||| EAN 8436017658255

📦 1 UNIT

**OSR6 - 6 liters**

||||| EAN 8436017658262

📦 1 UNIT

**OSR8 - 8 liters**

||||| EAN 8436017658279

📦 1 UNIT



**GR33 / GR25**



**Grill**

- Especially for meats and vegetables.
- **Enamelled cast iron:**
  - Perfect distribution of heat
  - Fast temperature transmission
  - Maintenance of maximum heat
  - Resistant and durable
  - Enamelled inside and outside
- Healthy and natural cuisine.
- Lateral handles.
- **Suitable for:**
  - Oven and barbecue
  - All types of kitchens: induction, gas, vitroceramic electric cooker
- Easy to clean.

*Fogo*



**GR33 - RECTANGULAR**

||||| EAN 8436017659689  
 4 UNITS  
**GRILL: 33 x 21,5 cm**

**GR25 - ROUNDED**

||||| EAN 8436017659672  
 4 UNITS  
**Ø GRILL : 25 cm**



**GMA28 / GP35**

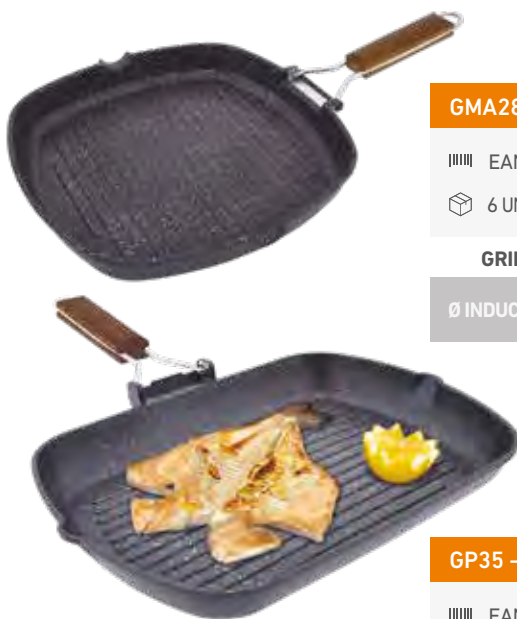

**GMA28 - SQUARED**

||||| EAN 8436017658910  
 6 UNITS  
**GRILL : 28 x 28 cm**

**Ø INDUCTION BASE 20,2 cm**

**GP35 - RECTANGULAR**

||||| EAN 8436017658927  
 6 UNITS  
**GRILL : 25 x 35 cm**

**Ø INDUCTION BASE 17,6 cm**

**Grill full induction**

**WOODEN FOLDABLE HANDLE**

- Full induction bottom.
- Pflun "Stonite" non-stick coating free of PFOA.
- Die-casting aluminium body.
- Perfect heat performance.
- Wavy surface for a fat free roast.
- Wooden foldable handle.
- Two pouring spouts.
- Suitable for all cookers, induction included.

*Kilimanjaro*



**stonite**  
 recubrimiento antiadherente

**PFLUON**  
 NON-STICK COATING  
 COATING





**TAAL**

# Serie Taal

- Whitford QuanTanium® 3 layers non-stick coating made without PFOA.
- Full induction bottom. Diameter 130 mm.
- Perfect heat performance.
- 3 mm. aluminium forged body.
- Fire resistant handle.
- Suitable for all cookers, induction included.



\*Except model CF916.



Full induction bottom



TAAL

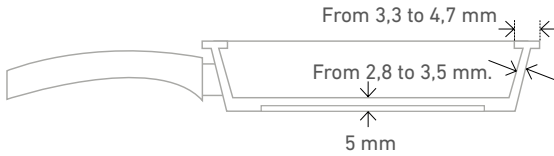

SF9

Full induction fry pan

| Model | Frying pan diameter | ∅ Induction base | UNITS | EAN           |
|-------|---------------------|------------------|-------|---------------|
| SF918 | 18 cm               | 13,5 cm          | 6     | 8436584381075 |
| SF920 | 20 cm               | 15,5 cm          | 6     | 8436584381082 |
| SF922 | 22 cm               | 17 cm            | 6     | 8436584381099 |
| SF924 | 24 cm               | 19 cm            | 6     | 8436584381105 |
| SF926 | 26 cm               | 20,5 cm          | 6     | 8436584381112 |
| SF928 | 28 cm               | 22 cm            | 6     | 8436584381129 |
| SF930 | 30 cm               | 23,5 cm          | 6     | 8436584381136 |



CF916

Full induction sauce pan

- Tempered glass lid
- Saucepan 16 cm
- Full induction bottom. Diameter 130 mm.
- Height 7 cm.
- Capacity 1,1 L.

EAN 8436584381167

6 UNITS



CF9

Full induction pot

- Tempered glass lid

| Model | Frying pan diameter | Capacity   | ∅ Induction base | UNITS | EAN           |
|-------|---------------------|------------|------------------|-------|---------------|
| CF920 | 20 cm               | 2,4 liters | 15,7 cm          | 3     | 8436584381174 |
| CF922 | 22 cm               | 2,6 liters | 18,5 cm          | 3     | 8436584381181 |
| CF924 | 24 cm               | 4 liters   | 19,5 cm          | 3     | 8436584381198 |



TF9

Full induction deep fry pan

- Tempered glass lid

| Model | Pan diameter | Height | ∅ Induction base | Capacity   | UNITS | EAN           |
|-------|--------------|--------|------------------|------------|-------|---------------|
| TF924 | 24 cm        | 6,8 cm | 18 cm            | 2,4 liters | 3     | 8436584381143 |
| TF928 | 28 cm        | 7,3 cm | 22 cm            | 3,6 liters | 3     | 8436584381150 |



**HSAR21\_**

# Stainless steel frying pan

FULL INDUCTION

- Whitford's Xylan Plus non-stick coating free of PFOA.
- Stainless steel body AISI-304
- Full induction bottom. Perfect heat performance.
- Bottom of 3,5 mm (3 mm of aluminum and 0,5 mm of steel 430)
- Suitable for all cookers, induction included.
- Hollow stainless handle for better hygiene and heat transmission.
- Suitable for over due to metallic components.

*La Garrotxa*



| Model    | Frying pan diameter | Ø Induction base | UNITS | EAN           |
|----------|---------------------|------------------|-------|---------------|
| HSAR2118 | 18 cm               | 12,5 cm          | 6     | 8436584382805 |
| HSAR2120 | 20 cm               | 14,5 cm          | 6     | 8436584382812 |
| HSAR2122 | 22 cm               | 17,2 cm          | 6     | 8436584382829 |
| HSAR2124 | 24 cm               | 18,7 cm          | 6     | 8436584382836 |
| HSAR2126 | 26 cm               | 19,8 cm          | 4     | 8436584382843 |
| HSAR2128 | 28 cm               | 21,7 cm          | 4     | 8436584382850 |
| HSAR2130 | 30 cm               | 21,7 cm          | 4     | 8436584382867 |



RECUBRIMIENTO  
**Xylan Plus**  
Whitford's line de cocina

LIBRE DE  
**PFOA**



HPAE21\_



La Garrotxa

## Stainless steel paella pan

FULL INDUCTION

- Full induction bottom.
- Whitford's Xylan Plus non-stick coating free of PFOA.
- Perfect heat performance.
- Stainless steel body AISI-304
- **Bottom:**
  - 4 mm (3,5 mm of aluminum and 0,5 mm of steel 430) 32 cm.
  - 4,1 mm (3,5 mm of aluminum and 0,6 mm of steel 430) 38 cm.
- Suitable for all cookers, induction included.
- Suitable for over due to metallic components.



RECUBRIMIENTO  
**Xylan Plus**  
Whitford's top quality non-stick

LIBRE DE PFOA

| Model    | Diameter | ∅ Induction base | Servings | Diffuser base | UNITS | EAN           |
|----------|----------|------------------|----------|---------------|-------|---------------|
| HPAE2132 | 32 cm    | 24,9 cm          | 5-6      | 4 mm          | 4     | 8436584382737 |
| HPAE2138 | 38 cm    | 31,0 cm          | 8-9      | 4,1 mm        | 4     | 8436584382744 |



## Wok - Frying pan

### FULL INDUCTION

- "Stonite" non-stick ceramic coating free of PFOA and PTFE.
- Silicone coating exterior:
- Anti-rust.
- Perfect heat performance.
- Aluminium forged body.
- Soft touch handle.
- Easy cleaning.
- Suitable for all cookers, induction included.

| Model  | Frying pan diameter | Depth  | Ø Induction base | UNITS | EAN           |
|--------|---------------------|--------|------------------|-------|---------------|
| SEW20M | 20 cm               | 6,2 cm | 12 cm            | 6     | 8436017656633 |
| SEW24M | 24 cm               | 7,2 cm | 15,5 cm          | 6     | 8436017656657 |
| SEW28M | 28 cm               | 7,5 cm | 18,3 cm          | 6     | 8436017656671 |

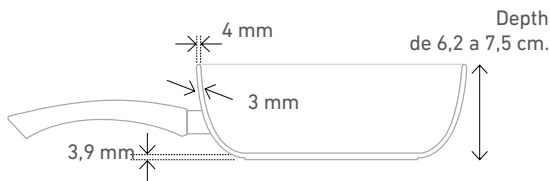

SEW\_

## Full induction fry pan

### ALUMINIUM FORGED - FULL INDUCTION

- Full induction bottom.
- "Stonite" Whitford's Xylan Plus non-stick coating free of PFOA.
- Perfect heat performance.
- 3 mm. aluminium forged body.
- Fire resistant handle.
- Suitable for all cookers, induction included.

| Model | Frying pan diameter | Ø Induction base | UNITS | EAN           |
|-------|---------------------|------------------|-------|---------------|
| SF118 | 18 cm               | 13,5 cm          | 6     | 8436017658439 |
| SF120 | 20 cm               | 15,7 cm          | 6     | 8436017658446 |
| SF122 | 22 cm               | 17,4 cm          | 6     | 8436017658453 |
| SF124 | 24 cm               | 18,8 cm          | 6     | 8436017658460 |
| SF126 | 26 cm               | 20,6 cm          | 6     | 8436017658477 |
| SF128 | 28 cm               | 22,3 cm          | 6     | 8436017658484 |
| SF130 | 30 cm               | 24 cm            | 6     | 8436017658491 |

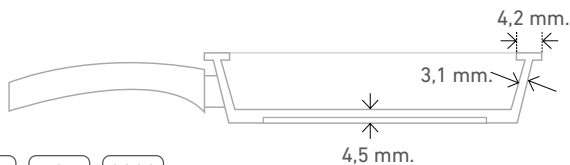

stonite  
recubrimiento antiadherente

RECUBRIMIENTO  
Xylan Plus  
Whitford's long-life non-stick

Set of 2 pans  
20 / 24 cm

SET SF1 2024

EAN 8436017658712

4 UNITS



Set of 3 pans  
18 / 22 / 26 cm

SET SF1 182226

EAN 8436584380641

4 UNITS

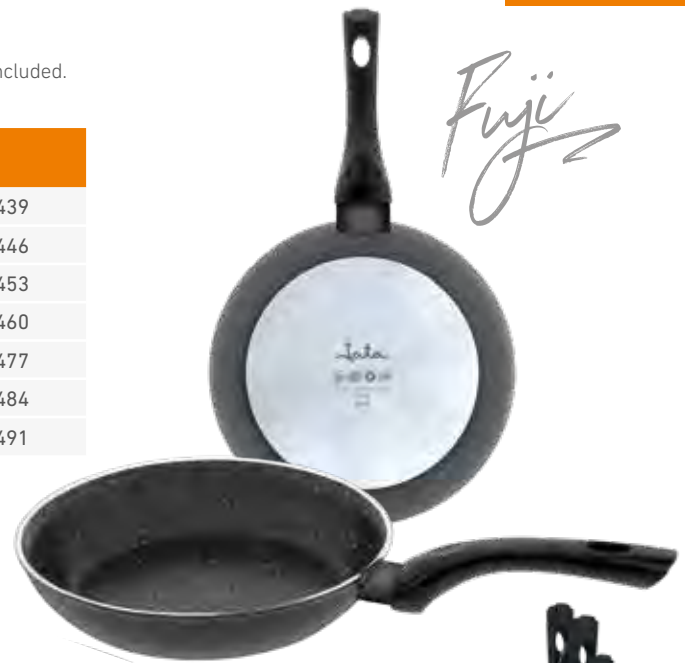

SF1\_

**HSAR24\_**

**Set of pans**  
FORGED ALUMINUM

**AUTUMN NOVELTY**

- PFOA-free Pflunon non-stick coating.
- 3003 aluminum body
- Induction diffuser base. Perfect heat distribution.
- Suitable for all stoves, including induction.
- 3.4 mm diffuser bottom (2.8 mm aluminum and 0.6 mm sus410 steel).
- Compact stackable storage, thanks to the design of the handles.



**Set of 2 pans**  
20 / 24 cm

**HSAR2402**

||||| EAN 8436584384953

📦 6 UNITS



**Set of 3 pans**  
18 / 22 / 26 cm

**HSAR2403**

||||| EAN 8436584384960

📦 4 UNITS



DISEÑO  
**APILABLE**  
MAYOR AHORRO  
DE ESPACIO



**SMH14**

**Fry pan**  
NON-STICK

**FRIED EGG**

- Dyflon non-stick coating free of PFOA.
- Ø 14 cm.
- Aluminium body.
- Silicone handle.
- Easy cleaning.
- Suitable for gas, electric, vitro and halogen cookers.
- Available in different colors.



12 UNITS  
DISPLAY BOX  
313 x 285 x 270 mm.

**SMH14**

||||| EAN 8436584381211

📦 1 EXP. 12 UNITS



## Forged aluminum cookware set

### FULL INDUCTION

- Full induction bottom
- "Stonite" Whitford's Xylan® Plus non-stick coating free of PFOA.
- Forged aluminum body.
- 3 mm sandwich base for maintenance, control and perfect heat diffusion.
- Suitable for all cookers, induction included.

*Fuji*

**BC3**

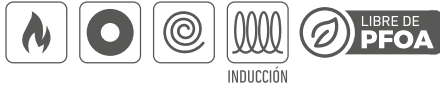

**stonite** RECUBRIMIENTO Plus **Xylan**  
recubrimiento antiadherente Whitford's long-life non-stick



| Diameter               | Capacity   | Height |
|------------------------|------------|--------|
| <b>Saucepan 16 cm</b>  | 1,1 liters | 7 cm   |
| <b>Casserole 20 cm</b> | 2,4 liters | 9,5 cm |
| <b>Casserole 24 cm</b> | 4,2 liters | 12 cm  |

**BC3**

||||| EAN 8436017659856

2 UNITS

## Cookware set

### 304 STAINLESS STEEL

- Impact Bounding base for perfect control and diffusion of heat.
- Tempered glass lid.
- Stainless steel handles and knobs with silicone protection.
- Suitable for all cookers, induction included.

**BC8 / BC10**



**BC8** 4 pieces SUS304 stainless steel with lid.

| Diameter                  | Capacity   | Height |
|---------------------------|------------|--------|
| <b>Saucepan 16 cm</b>     | 1,8 liters | 9 cm   |
| <b>Casserole 18 cm</b>    | 2,5 liters | 10 cm  |
| <b>Casserole 22 cm</b>    | 4,5 liters | 12 cm  |
| <b>Deep fry pan 24 cm</b> | 3 liters   | 6,5 cm |

||||| EAN 8436017659221

2 UNITS

**BC10** 5 pieces SUS304 stainless steel with lid.

| Diameter                  | Capacity   | Height |
|---------------------------|------------|--------|
| <b>Saucepan 16 cm</b>     | 1,8 liters | 9 cm   |
| <b>Casserole 18 cm</b>    | 2,5 liters | 10 cm  |
| <b>Casserole 20 cm</b>    | 3,2 liters | 11 cm  |
| <b>Casserole 24 cm</b>    | 6 liters   | 13 cm  |
| <b>Deep fry pan 26 cm</b> | 3,5 liters | 6,5 cm |

||||| EAN 8436017659238

2 UNITS



T16 / T20 / T26

Multifunction glass and silicone lid

- Universal silicone and "temperit" glass lid.
- Without metallic components, suitable for the microwave and dishwasher.
- Multifunctional: for fry pans, pots, pans, etc.
- Hygienic and healthy, complies with FDA regulations.
- Steam outlet valve.
- Suitable for diameters of: 16 – 18 – 20 cm.



T16

||||| EAN 8436584380276  
 6 UNITS

T20

||||| EAN 8436584380283  
 6 UNITS

T26

||||| EAN 8436584380290  
 6 UNITS

HACC4546

SPRING NOVELTY

Magnetic silicone trivet

- Magnetized: adheres to the bottom of pans, pots and pans, as well as other metal surfaces such as refrigerators, etc.
- 20x20cm silicone surface.
- Heat resistant up to 230°C
- Flexible and non-slip.
- Does not scratch.
- Easy cleaning and storage.



Video



12 UNITS  
 DISPLAY BOX  
 21 x 26 x 19.5 cm



20 x 20 cm  
 SUPERFICIE



T° MÁXIMA  
 230 °C

HACC4546

||||| EAN 8436584384809  
 12 UNITS

## Set of mould and mini electric blender with chopper

- 2 stainless steel whisks included.
- Comfortable, cordless. USB rechargeable, included.
- 300 ml capacity mini chopper.
- 5 adjustable power levels.
- Charge indicator light.
- Power 45 w

**MEASUREMENTS**  
L x W x H cm  
7,5x17,5x22

**MOULD MEASUREMENTS**  
L x W x H cm  
27x17x6

### DINOSAUR SHAPED PASTRY MOULD

- Silicone mould, non-stick, flexible and easy to unmold.
- Suitable for oven, freezer, microwave and dishwasher.
- Resistant to high and low temperatures: from -40 °C to 230 °C
- Uniform cooking.
- Suitable for baking.
- Capacity 950 ml.
- Free of BPA.



**USB CHARGE**  
CABLE INCLUDED



**HSET1234**

**HSET1234**

||||| EAN 8436584384212

📦 6 UNITS



## Kitchen moulds Chef Bosquet

- Silicone mould, non-stick, flexible and easy to unmold.
- Suitable for baking and cooking.
- Free of BPA.
- Suitable for oven, freezer, microwave and dishwasher.
- Resistant to extreme temperatures: up to 220 °C and -40 °C.
- Uniform cooking.

*Donut recipes without regrets*



**HMOL521\_**

100% SILICONA PLATINO LIBRE DE BPA

### HMOL5211 CHOCOLATE BARS

| Mould size | Height | Capacity   | Hollow size (L x W x H) | UNITS | EAN           |
|------------|--------|------------|-------------------------|-------|---------------|
| 29 x 18 cm | 3,1 cm | 60 ml x 12 | 8 x 3 x 3 cm            | 6     | 8436584382973 |



### HMOL5212 DONUTS

| Mould size   | Height | Capacity    | Hollow size (L x W x H) | UNITS | EAN           |
|--------------|--------|-------------|-------------------------|-------|---------------|
| 34 x 26,5 cm | 2,9 cm | 100 ml x 12 | 7,5 x 2,5 x 3 cm        | 6     | 8436584382980 |



### HMOL5213 KITCHEN MOULD - SAVARIN

| Mould size | Height | Capacity   | Hollow size (L x W x H) | UNITS | EAN           |
|------------|--------|------------|-------------------------|-------|---------------|
| 34 x 24 cm | 2,7 cm | 70 ml x 12 | 6,5 x 2,2 x 3 cm        | 6     | 8436584382997 |



## Kitchen moulds

- Platinum silicone mould, non-stick, flexible and easy to unmold.
- Free of BPA.
- Suitable for oven, freezer and microwave.
- Resistant to extreme temperatures: up to 240 °C and 50 °C below zero.
- Uniform cooking.



Download our special recipes in:  
[www.jata.es](http://www.jata.es)



| Model                  | Measures                | Height |
|------------------------|-------------------------|--------|
| <b>MC60 / HMOL5216</b> | Ø 26 cm                 | 3 cm   |
| <b>MC61 / HMOL5214</b> | Ø 21 cm                 | 10 cm  |
| <b>MC62</b>            | 4,5 liters              | 3 cm   |
| <b>HMOL5219</b>        | 6 hollows: Ø 6 cm       | 6,5 cm |
| <b>MC64</b>            | Rectangular: 24 x 10 cm | 4,5 cm |
| <b>HMOL5215</b>        | 20 x 19 cm              | 6 cm   |
| <b>MC67 / HMOL5218</b> | Ø 23 cm                 | 5,5 cm |
| <b>MC68</b>            | 6 flans Ø 7,5 cm        | 4,5 cm |
| <b>HMOL2065</b>        | 27 x 17 cm              | 6 cm   |



LIBRE DE BPA

100% SILICONA PLATINO

6 UNITS



### SPECIAL CAKES

**MC60** EAN 8436017659153  
**HMOL5216** EAN 8436584383024



### SPECIAL SPONGE

**MC61** EAN 8436017659160  
**HMOL5214** EAN 8436584383000



### 6 CUPS FOR MUFFINS

**MC62** EAN 8436017659177



### PLUM CAKE

**HMOL5219** EAN 8436584383055



### LASAGNA

**MC64** EAN 8436017659191



### FOR BAKING

**HMOL5215** EAN 8436584383017



### SET OF 6 FLANS

**MC67** EAN 8436017659535  
**HMOL5218** EAN 8436584383048



### MOULD WITH LID

**MC68** EAN 8436017659542



### DINOSAUR SHAPED MOULD

**HMOL2065** EAN 8436584384229



## Removable silicone mould

### TEMPERED GLASS BASE

- Silicone mould, non-stick, flexible and easy to unmold.
- Suitable for baking and cooking.
- Free of BPA.
- Suitable for oven, freezer and dishwasher.
- Resistant to extreme temperatures: up to 230 °C and -20 °C.



#### HMOL1124

||||| EAN 8436584385288

📦 4 UNITS

Ø 26 cm / Height 6,4 cm

#### HMOL1324

||||| EAN 8436584385301

📦 4 UNITS

26.5 x 13.2 x 6.2 cm



## HMOL1124 / HMOL1324

### AC40

## Ice cube tray

- Silicone ice cube tray, 21 cubes of 3 x 3 cm.
- 100% platinum silicone paraffin.
- Flexible, for an easy demoulding.
- Protective cover, allows stacking, avoids spills, isolates the inside from the outside.
- Ideal to make ice cubes of fruits, herbs and coffee for cocktails.
- Suitable for freezing sauces, soups, chocolate and jelly.
- Suitable for the oven, microwave to defrost, and dishwasher.

*Essential*



||||| EAN 8436584380689

📦 12 UNITS



### HACC4540

## Ice cube tray

- 100% paraffin-coated silicone tray for 15 cubes.
- Non-stick and flexible. Very easy to demold.
- Suitable for ovens, microwaves, and dishwashers. -40 °C - 230 °C.
- Ideal for freezing stocks, chocolate, jelly, and sauce, or for creating cubes with fruits and/or aromatic herbs for cocktails and mixes.
- Protective cover, allows stacking, avoids spills, isolates the inside from the outside.



||||| EAN 8436584384816

📦 12 UNITS



12 UNITS  
DISPLAY BOX  
21 x 26 x 19.5 cm



**HACC4624**

**SPRING NOVELTY**



# 7 piece kitchen utensils set

- Nylon and Stainless Steel kitchen utensil
- Hygienic and healthy, complied with FDA and LFGB standards.
- Does not scratch.
- Temperature Max. 210 °C.
- Non-slip hook support included.

**HACC4624**

EAN 8436584385080

6 UNITS



Normativa  
**FDA CE**  
**LFGB**



T<sup>MAX</sup> 210 °C



SOPORTE  
ANTIDESLIZANTE



SOUP LADLE



LADLE WITH HOLES



SKIMMER



PASTA SERVER



TURNER



SPATULA WIHT HOLES

**HACC4600**

**Kitchen tool set**

- Nylon kitchen utensils:
  - Soup ladle.
  - Skimmer spoon.
  - Serving spoon.
  - Pasta server.
  - Slotted turner.
  - Turner.
- Ergonomic handle of anti-slip TPR silicone.
- Hygienic and healthy, complied with FDA and LFGB standards.
- Temperature Max. 210 °C.
- Table stand included.



||||| EAN 8436584382669    6 UNITS



**7 pieces**



**HACC43\_**

**Kitchen tools**

- Handle of stainless steel.
- Temperature resistance up to 250 °C.
- Can be hung on wall hooks.
- Hygienic and healthy, complied with FDA and LFGB standards.
- Suitable for dishwasher.



12 UNITS

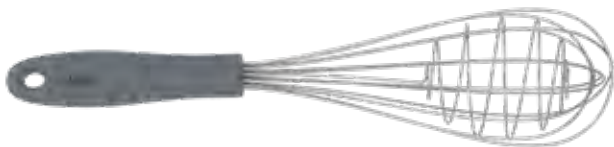

**EGG BEATER**

**HACC4301**    ||||| EAN 8436584383819



**SILICONE SPATULA**

**HACC4303**    ||||| EAN 8436584383833



**SPOON**

**HACC4304**    ||||| EAN 8436584383840



**TURNER**

**HACC4305**    ||||| EAN 8436584383857



**SOUP LADLE**

**HACC4306**    ||||| EAN 8436584383864



**SKIMMER**

**HACC4307**    ||||| EAN 8436584383871



HACC5460



## Set of utensils and support "Kitchen basics"

- It includes 6 silicone and stainless steel of the highest quality.
- Practical and comfortable way of storage.
- Non-stick.
- Includes exclusive stickers to customize.
- BPA free.

HACC5460

||||| EAN 8436584384151

📦 6 UNITS



Normativa  
FDA CE  
LFGB

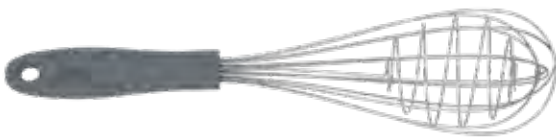

WHISK



SPATULA



LADLE



TURNER



SOUP LADLE



SKIMMER

AC\_

Kitchen tools

- Nylon soup ladle.
- Ergonomic handle.
- Hygienic and healthy, complied with FDA and LFGB standards.
- Heat resistance over 200 °C.
- Suitable for the dishwasher.
- Stainless steel cutting area.

*Essential*



Normativa  
FDA CE  
LFGB

12 UNITS



SOUP LADLE

AC1

||||| EAN 8436017660142



PASTA SERVER

AC3

||||| EAN 8436017660166



TURNER

AC4

||||| EAN 8436584380412



PIZZA CUTTER

AC21

||||| EAN 8436584380436

- Stainless steel blade.
- Diameter 65 mm



MULTI-FUNCTION PEELER

AC23

||||| EAN 8436584380450

AC\_  
Kitchen tools



Normativa  
FDA CE  
LFGB

12 UNITS



Y-PEELER SPAGHETTI  
JULIENNE

HACC4520 ||||| EAN 8436584382263



EGG BEATER

AC26 ||||| EAN 8436584380481



APPLE SEED REMOVER

AC29 ||||| EAN 8436017660272

Stainless steel cutting area.



THIN ETCHED GRATER

A31 ||||| EAN 8436584380535

Cutting protector.



SILICONE SPATULA

AC33 ||||| EAN 8436584380559



Y-PEELER

AC24 ||||| EAN 8436584380467

Especial para tomate y frutos de piel fina y carne blanda.



MELON BALLER

AC28 ||||| EAN 8436584380504

Acero inoxidable



ETCHED GRATER

AC30 ||||| EAN 8436584380528

Cutting protector.



THICK ETCHED GRATER

AC32 ||||| EAN 8436584380542

Cutting protector.



CUTTING PROTECTOR  
FOR MODELS:  
AC30 / AC31 / AC32



KITCHEN BRUSH

AC34 ||||| EAN 8436584380207





AC\_  
Kitchen tools



Normativa  
FDA CE  
LFGB

12 UNITS



KITCHEN TONGS

AC35 EAN 8436584380214



STRAINER - Ø 12 CM

AC25 EAN 8436017660234

Stainless steel



DETACHABLE MULTIPURPOSE  
KITCHEN SCISSORS

AC36 EAN 8436584380221

Multipurpose scissors: Nutcracker. - Bottle opener  
- Fish descaling - Cutting function.



SILICONE KITCHEN TONGS SET

HACC4522 EAN 8436584384373

12 units. Box / Display box available.



HACC4541

Knife sharpeners

- 3 sharpening processes: Roughing (Tungsten), sharpening (diamond) and polishing (ceramic).
- Swipe in one direction, backwards.
- Non-slip handle and base.
- Suitable for knives of all sizes.
- Simple and comfortable handling.
- Effective sharpening.



Roughing



Sharpening



Polishing



SIZE L x W x H  
6,4 x 21,6 x 5,2 cm

EAN 8436584383789

12 UNITS



➔ MOVER SIEMPRE EN UN MISMO SENTIDO



With knife sharpener

**HACC4502**

**SET OF 5 KNIVES AND SUPPORT BOARD**

- The five essential knives in the kitchen:
  - Paring.
  - Utility knife
  - Santoku.
  - Onion.
  - Bread.
- Magnetized table to store knives in a visible way.
- Special polypropylene handle for food use.
- 3Cr13 steel remarkable for its strength, hardness and resistance to corrosion.
- Non-stick coating.
- Ergonomic and exclusive design.



TABLA SOPORTE  
**IMANTADA**

||||| EAN 8436584383796

📦 6 UNITS

**HACC4503**

**Set of 5 kitchen knives**

STORAGE CASE WITH MAGNETIC CLOSURE

- The five essential knives in the kitchen:
  - Paring.
  - Utility knife
  - Santoku.
  - Onion.
  - Bread.
- Presentation/storage case with magnetic closure.
- Special polypropylene handle for food use.
- 3Cr13 steel remarkable for its strength, hardness and resistance to corrosion.
- Non-stick coating.
- Ergonomic and exclusive design.



RECUBRIMIENTO  
**ANTIADHERENTE**

EMPUÑADURA  
**ERGONOMICA**

||||| EAN 8436584383802

📦 6 UNITS



**HACC4504**

**5 knives set with support**  
CYLINDRICAL BLOCK TO STORE KNIVES

- As cinco facas essenciais na cozinha:
  - Faca de bico.
  - Multiuso
  - Faca Santoku.
  - Faca de Chef.
  - Faca de pão.
- Cylindrical block to store knives.
- Special polypropylene handle for food use.
- Special steel for cutting and sharpening.
- Non-stick coating.



||||| EAN 8436584383925

📦 6 UNITS



HACC4531



## Cutting board with knife sharpener

*2 in 1*

- Polypropylene cutting board.
- With ceramic knife sharpener.
- Ranhura de coleta de líquido.
- High resistance.
- Easy to clean.
- Two positions: flat and inclined.
- Non-slip silicone on the perimeter.
- Size: 33,6 x 23,6 x 2,4 cm
- Suitable for dishwasher.



HACC4531

EAN 8436584383161

6 UNITS





3 in 1



Microwave lid



Drainer



Steamer

**HACC4530**

**Multipurpose kitchen cover**

- Three functions of use:
  - Drainer
  - Microwave lid.
  - Steamer.
- Diameter 26 cm.
- Foldable.
- Maximum heat resistance 100°
- Free of BPA.
- Compact, lightweight and durable.



LIBRE DE BPA PLEGABLE

||||| EAN 8436584383062

📦 12 UNITS

**HACC4533**

**Spill stopper and steamer lid**

- Works as a spill stopper and steamer lid.
- Avoids boil overflow.
- 100% silicone
- BPA free.
- Suitable for microwave and oven use, maximum 230 degrees
- For cooking utensils between 14 and 26 cm
- 2 handles to hold and hang.
- Size: 30 x 26 cm



Video

For Ø 14 -26 cm containers



2 in 1

100% SILICONA PLATINO LIBRE DE BPA

**spill stopper lid**



**Steamer**

||||| EAN 8436584383260

📦 6 UNITS



**HACC4524**

**Silicone glove and half glove for the kitchen**  
2 PIECES

- Agarre flexible y antideslizante.
- BPA free.
- Hanging ring.
- Resistant to extreme temperatures, from -40 to 230° C
- Ambidextrous use.
- **Glove:**
  - Ergonomic design, extra long.
  - Padded and breathable cotton interior.
  - Sizes: 36,5 x 18,5 x 1,3 cm.
- **Half glove:**
  - Sizes: 10,7 x 8,5 x 7 cm.

AGARRE FLEXIBLE ANTIDESLIZANTE 100% EXTERIOR SILICONA PLATINO LIBRE DE BPA T° MÁXIMA 230 °C

||||| EAN 8436584385189

📦 6 UNITS

## Manual vacuum pump set

+ 12 BAGS

- Includes 12 reusable bags
- Vacuum packed and hermetically sealed.
- Prolongs food preservation.
- Bags suitable for refrigerator or freezer.
- Compatible with all vacuum bags with a valve.
- Temperature of use between -15° and 110° C.
- Easy to use.
- Includes two clips for a more accurate closure.



Video



HACC4542

||||| EAN 8436584383666

📦 6 UNITS



HACC4542

## Set of 12 spare bags for vacuum

- Vacuum packed and hermetically sealed.
- BPA free.
- Prolongs food preservation.
- Suitable for refrigerator or freezer.
- Temperature of use between -15° and 110° C.
- Includes two clips for a more accurate closure.



Includes 12 reusable bags  
x4: 22 x 21 cm  
x4: 22 x 28 cm  
x4: 26 x 34 cm

HACC4543

||||| EAN 8436584383673

📦 12 UNITS



HACC4543

## ARA30

### Anti mold foam

SUITABLE FOR ALL FRIDGES

- Fruits and vegetables always fresh.
- Delays the decomposition of food.
- Antibacterial.
- Air circulation from all sides to prevent mold.
- Complied with FDA and LFGB standards.
- Cut-out, to adjust to the necessary size.
- Washable.
- Suitable for all fridges.



Measures: 52 x 33 x 1,5 cm.

||||| EAN 8436584381235

📦 12 UNITS





Two-color ergonomic handle.

**AC37**

**Set of 2 knives**  
UTILITY AND VEGETABLES

*Essential*

- 1 paring knife. Blade size, 75 mm.
- 1 utility knife. Blade size, 100 mm.
- Stainless steel blade 440, 1.2mm 5CR15MOV.
- Two-color ergonomic handle.
- Suitable for the dishwasher.



||||| EAN 8436584381051

📦 12 UNITS

**AC38**

**Set of 3 knives**  
DE MESA

*Essential*

- 3 utility knives.
- Blade size, 120 mm.
- Stainless steel blade 440, 1.2mm 5CR15MOV.
- Two-color ergonomic handle.
- Suitable for the dishwasher.



||||| EAN 8436584381068

📦 12 UNITS



Two-color ergonomic handle.



**HACC4500**

**Set of 2 knives**  
COZINHA E SANTOKU

*Essential*

- 1 paring knife. Blade size, 170 mm.
- 1 Santoku knife. Blade size, 160 mm.
- Stainless steel blade 440, 1.8mm 5CR15MOV.
- Two-color ergonomic handle.



Two-color ergonomic handle.



||||| EAN 8436584382041

📦 12 UNITS



AC54

**Chopper**  
REMOVABLE

- Special for onion, vegetables, hard boiled egg, fruits and nuts.
- Stainless steel blade.
- BPA free.
- Complied with FDA and LFGB standards.
- Removable for easy cleaning.
- Suitable for the dishwasher.



||||| EAN 8436584380344

📦 6 UNITS

*Master Cut*



HMAQ4504

**Multi-slicer**  
SPAGHETTI MASTER CUT

- Special for potatoes, fruits / vegetables and cheese.
- **2 interchangeable stainless-steel blades:**
  - 1 blade for julienne strips and thick cubes.
  - 1 blade for julienne strips and thin cubes.

- Spiral cutting accessory with 3 different shapes.
- BPA free. Complied with FDA and LFGB standards.
- Removable for easy cleaning. Suitable for the dishwasher.
- Accessory for cleaning.
- Anti-sliding base.

*Master Cut*



||||| EAN 8436584382065

📦 6 UNITS

HMAQ4501

**Chopper / blender**  
MANUAL MINI

- Manual use.
- **2 interchangeable accessories:**
  - Stainless steel blade with 3 cutting heights, to chop all kind of food, garlic, onion.
  - Whisk for mixing and emulsion, to prepare sauces and creams.
- BPA free.
- Complied with LFGB standard.
- Capacity 350 ml.
- Easy cleaning.
- Anti-sliding base.



||||| EAN 8436584381488

📦 6 UNITS

*Master Cut Pro*





Master Cut



**HMAQ4557**

**Manual chopper**

- Manual rope traction mechanism.
- Stainless steel blade with 3 cutting heights, to chop all kind of food, garlic, onion.
- Chop all kinds of food.
- BPA free.
- Complied with FDA and LFGB standards.
- Anti-sliding base.
- Transparent container with a total capacity of 500 ml.
- Maximum capacity of use 350 ml.



12 UNITS  
**DISPLAY BOX**

21 x 41,5 x 27 cm



||||| EAN 8436584384557

📦 12 UNITS

**AC57E**

**Chopper / blender**  
MANUAL MINI

- Manual use.
- **2 interchangeable accessories:**
  - Stainless steel blade with 3 cutting heights, to chop all kind of food."
  - Whisk for mixing and emulsion."
- BPA free.
- Complied with FDA and LFGB standards.
- Anti-sliding base.
- Transparent container with a total capacity of 500 ml.
- Maximum capacity of use 350 ml.

Master Cut



Video

9 UNITS  
**DISPLAY BOX**

405 x 342 x 133 mm



||||| EAN 8436584380375

📦 9 UNITS



900 ml  
**RECIPIENTE CON TAPA**

**HMAQ4506**

**Manual chopper / blender**

- Manual use.
- **2 interchangeable accessories:**
  - Stainless steel blade with 4 cutting heights. To chop all kind of food, garlic, onion.
  - Whisk for mixing and emulsion. To prepare sauces and creams.
- Lid to keep food fresh.
- Reinforced ultra-resistant container.
- Diameter: 12,5 cm. Height: 14 cm
- BPA free.
- Complied with FDA and LFGB standards.
- Anti-sliding base.
- Transparent container with a total capacity of 900 ml.
- Maximum capacity of use 750 ml.



6 UNITS  
**DISPLAY BOX**

40 x 29 x 15 cm



||||| EAN 8436584384274

📦 6 UNITS

AC51

## Mini multi grater WITH 3 ROLLS

- Special for cheese, vegetables and nuts.
- **3 interchangeable stainless steel rolls:**
  - Fine grated cut.
  - Thick grated cut.
  - Slices cut.

- BPA free.
- Complied with FDA and LFGB standards.
- Removable for easy cleaning.
- Suitable for the dishwasher.

*Master Cut*



Pusher/hand guard



||||| EAN 8436584380313

📦 6 UNITS



*Master Cut*  
3 em 1

HMAQ4505

## Manual chopper, blender, juicer master cut MASTER CUT

- **3 interchangeable accessories:**
  - Stainless steel blade with 3 cutting heights, to chop all kind of food, garlic, onion and ice.
  - Whisk for mixing and emulsion, to prepare sauces and creams.
  - Juicer.
- BPA free.
- Complied with FDA and LFGB standard.
- Capacity 1,5 L.
- Easy cleaning.
- Anti-sliding base.



||||| EAN 8436584382560

📦 6 UNITS

HMAQ4508

## Mini spiralizer

- Manual rotary lever to make different cuts.
- Ideal for fruits and vegetables.
- Non-slip grip.
- 4 stainless steel blades.

- Compact and easy to store.
- BPA free.
- Complied with FDA and LFGB standards.
- Measures: 11 x 9,2 x 7,5 cm



12 UNITS  
**DISPLAY BOX**

36.5 x 27.5 x 10 cm

||||| EAN 8436584384304

📦 12 UNITS



**4 TIPOS DE CORTE**



**HACC4545**



**Oil sprayer**

- Evenly dose the oil on the food.
- Easily refillable.
- Made of glass and polypropylene
- Especially suitable for all kinds of oils, vinegars, essences or liquids.
- BPA free.
- Practical, modern and resistant design.
- Measures: 16,8 x 6,3 cm
- Capacity 150 ml



**12 UNITS  
DISPLAY BOX**  
29,5 x 22,5 x 33.5 cm



**HACC4545**

||||| EAN 8436584384465

📦 12 UNITS

**HACC45\_**



**Anti-drip glass oil bottle**

- Borosilicate glass, safe and non-toxic.
- Maintains the original flavor of the oil.
- Anti-drip system. Not stain.
- Hand blown glass.
- Easy cleaning.



**HACC4537**



**HACC4536**



**HACC4535**

| Model           | Capacity | Measures              | UNITS | EAN           |
|-----------------|----------|-----------------------|-------|---------------|
| <b>HACC4537</b> | 500 ml   | 11,7 x 11,7 x 21,5 cm | 6     | 8436584383741 |
| <b>HACC4536</b> | 250 ml   | 9 x 9 x 19,5 cm       | 6     | 8436584383734 |
| <b>HACC4535</b> | 125 ml   | 7,3 x 7,3 x 16,7 cm   | 6     | 8436584383727 |



**SET OF 3 SPARE CAPS**

| Model           | Capacity | UNITS | EAN           |
|-----------------|----------|-------|---------------|
| <b>HRAC4537</b> | 500 ml   | 12    | 8436584383772 |
| <b>HRAC4536</b> | 250 ml   | 18    | 8436584383765 |
| <b>HRAC4535</b> | 125 ml   | 24    | 8436584383758 |

## Pressure oil sprayer

- Dose by spraying the oil evenly on the food.
- Refillable.
- Made of glass, polypropylene and stainless steel.
- Especially suitable for all kinds of oils, vinegars, essences or liquids.
- BPA free.
- Practical, modern and resistant design.
- Measures: 6,2 x 16,5 cm
- Capacity 150 ML



**OVER-PRESSURE**  
Oil sprayer



HACC4539

||||| EAN 8436584384397

📦 10 UNITS



**HACC4539**



## Salad spinner

- Spin, washing and drying salads and vegetables.
- Liquid inlet and outlet slot.
- BPA free.
- Swivel twist in both directions.
- Measures: 22,8 x 16,5 cm
- Capacity 3 L.



HACC4554

||||| EAN 8436584384441

📦 6 UNITS

3L  
CAPACIDAD

🥗 LAVADO  
Y SECADO

LIBRE DE  
BPA

🔄 ROTACIÓN  
BIDIRECCIONAL

**HACC4554**



**HTER21\_**



6 UNITS  
**DISPLAY BOX**

**Double wall thermo**

- Thermos with double-walled glass bottle with great thermal insulation.
- Preserve the drink cold or heat during 6 hours with a 25% difference and 12 hours with 50%
- BPA free.
- Light and easy to transport.
- Hermetic locking.
- Do not absorb odors or flavors.
- Thread lid for using as a cup.



| Model    | Capacity | EAN           |
|----------|----------|---------------|
| HTER2125 | 250 ml   | 8436584382676 |
| HTER2150 | 500 ml   | 8436584382683 |
| HTER2175 | 750 ml   | 8436584382690 |
| HTER2100 | 1 liter  | 8436584382706 |



**942 / 943**



942

943

**Lunch box**

2 - 3 LiterS

- Double isolating wall to preserve better cold or warm food.
- BPA free.
- Hygienic and healthy, complied with FDA standard.
- High resistance against shock.
- 1 L recipient included. Suitable for the microwave.
- Transport handle.



| Model | Capacity | EAN           |
|-------|----------|---------------|
| 942   | 2 liters | 8436017658781 |
| 943   | 3 liters | 8436017658798 |



Includes a 1 liter container.  
Microwave safe





825 / 827

Vacuum flask  
STAINLESS STEEL

- Double wall stainless steel. High quality.
  - Inner side: stainless steel 304.
  - Outer side: stainless steel 201.
- Preserves food hot or cold for several hours.
- Inner lid with decompression valve for an easy opening.
- BPA free.
- Silicone base and non-slip grip zone.
- High resistance against drop shock.
- Light and easy to transport.
- Hermetic locking.
- Thread lid.



| Model | Capacity | EAN           |
|-------|----------|---------------|
| 825   | 500 ml   | 8436017658866 |
| 827   | 750 ml   | 8436017658873 |



Inner lid with decompression valve for easy opening.

BASE  
SILICONA



Pourer with opening regulator

83\_

Vacuum flask  
STAINLESS STEEL - FROM 250 TO 1.000 ml

- Double wall stainless steel. High quality.
  - Inner side: stainless steel 304.
  - Outer side: stainless steel 201.
- BPA free.
- Silicone base and non-slip grip zone.
- High resistance against drop shock.
- Light and easy to transport.
- Hermetic locking.
- Preserve the drink cold or heat for hours.
- Thread lid for using as a cup.
- Fast closing / opening pouring lip, just pressing with the finger.
- Capacity 750 ml.
- Detachable, easy clearing.
- Thermal insulation



| Model | Capacity | EAN           |
|-------|----------|---------------|
| 835   | 250 ml   | 8436017658507 |
| 836   | 500 ml   | 8436017658514 |
| 837   | 750 ml   | 8436017658521 |
| 838   | 1 liter  | 8436017658538 |

BASE  
SILICONA

840

Personal travel thermo

- Double wall stainless steel. High quality.
  - Inner side: stainless steel 304.
  - Outer side: stainless steel 201.
- IBPA free.
- Thermal insulation. Preserve the drink cold or heat for hours.
- Screw lid.
- Hermetic locking with opening pusher.
- Folding handle for hanging.
- Light and easy to transport.



||||| EAN 8436017659702    6 UNITS



Hermetic closure with opening button



Folding handle for hanging



826



500 ml



Hermetic closure with opening button



Folding handle for hanging

## Personal travel thermo

GRAY AND GREEN - 500 ml

- Double wall stainless steel. High quality.
  - Inner side: stainless steel 304.
  - Outer side: stainless steel 201.
- BPA free.
- Thermal insulation. Preserve the drink cold or heat for hours.
- Screw lid.
- Hermetic locking with opening pusher.
- Folding handle for hanging.
- Light and easy to transport.

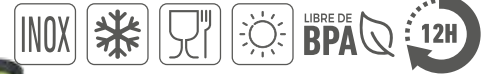

826  
 EAN 8436584380108  
 6 UNITS

6 UNITS  
 DISPLAY BOX  
 24.5 x 18 x 27 cm

909 / 918 / 919 / 920



## Vacuum flask

STAINLESS STEEL- DE 250 A 1.000 ml

- Double wall stainless steel. High quality.
  - Inner side: stainless steel 304.
  - Outer side: stainless steel 201.
- IBPA free.
- High resistance against drop shock.
- Light and easy to transport.
- Hermetic locking.
- Preserve the drink cold or heat for hours.
- Thread lid for using as a cup.
- Fast closing / opening pouring lip, just pressing with the finger



| Model | Capacity | EAN           |
|-------|----------|---------------|
| 909   | 250 ml   | 8436017658040 |
| 918   | 500 ml   | 8436017657746 |
| 919   | 750 ml   | 8436017658057 |
| 920   | 1 liter  | 8436017658064 |



6 UNITS  
**DISPLAY BOX**



**AUTUMN  
NOVELTY**

**HTER1011 / HTER1001**



## Stainless steel bottle

- **Double wall stainless steel. High quality.**
  - Inner side: stainless steel 304.
  - Outer side: stainless steel 201.
- BPA free.
- Hermetic screw closure.
- Preserve the drink cold or heat for hours.
- Capacity 500 ml.



**10 UNITS  
DISPLAY BOX**  
16.1 x 39,2 x 27 cm

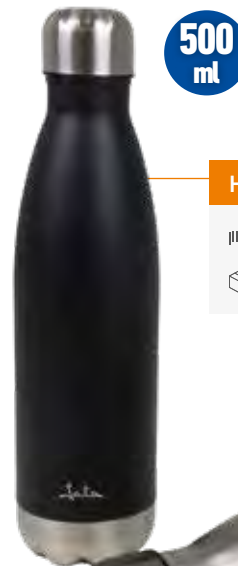

**500  
ml**

**HTER1011 - BLACK**

||||| EAN 8436584385226

📦 10 UNITS



**HTER1001 - SILVER**

||||| EAN 8436584385219

📦 10 UNITS



EXCLUSIVE DESIGN



KUKUXUMUSU®



6 UNITS  
DISPLAY BOX  
25 x 19 x 18 cm

**rPET**  
Equivalente a 1 botella de plástico

HPOR7202

Thermal sandwich bag

EARTH

- RPET material: 100% recycled plastic made from 1 plastic bottle.
- Ideal for hot or cold sandwiches, snacks, lunches...
- Velcro
- Capacity: 1,6 L.
- Customizable: identifying textile label.
- Comfortable and practical design thanks to backside hanger
- Aluminum hanger.
- Waterproof inner material.
- BPA free.
- 2 practical side zippers.
- Size: 18 x 4,5 x 21 cm

**rPET**  
100% Plástico reciclado



Interior Termosellado  
Aislante frío / calor hasta 4h



REUTILIZABLE  
ESPECIAL PARA BOCADILLOS Y ALMUERZOS

||||| EAN 8436584384250

6 UNITS

LIBRE DE BPA

HPOR7203

Thermal sandwich holder

OCEAN

- RPET material: 100% recycled plastic made from 1 plastic bottle.
- Hot/cold insulated interior to ensure better food preservation.
- It includes an interior strap to hold the contents and a mesh pocket for cutlery and napkins.
- Capacity: 0,9 L
- Customizable: identifying textile label.
- Aluminum hanger.
- BPA free.
- Size: 15,5 x 4 x 15,5 cm

**rPET**  
100% Plástico reciclado



Interior Termosellado  
Aislante frío / calor hasta 4h

REUTILIZABLE  
Especial para SANDWICHES

||||| EAN 8436584384267

6 UNITS

LIBRE DE BPA

EXCLUSIVE DESIGN



KUKUXUMUSU®



6 UNITS  
DISPLAY BOX  
25 x 19 x 18 cm

**rPET**  
Equivalente a 1 botella de plástico

HPOR7056

Thermal

FOOD BAG 2 PIECES

- RPET material: 100% recycled plastic made with the equivalent of 4 plastic bottles.
- Two independent compartments.
- Lower compartment with hot/cold insulated interior to ensure better food preservation.
- Insulates up to 4 hours.
- Capacity 30 L.
- Large capacity removable upper compartment, with anti-sand and dirt grid. With inside pocket with zipper.
- Comfortable wide top handles
- Seamless heat-sealed waterproof inner material.
- Sizes: 48 x 18 x 48 cm.

**rPET**  
100% Plástico reciclado



Interior Termosellado  
Aislante frío / calor

2 COMPARTIMENTOS INDEPENDIENTES y desmontables

||||| EAN 8436584383178

6 UNITS



LIBRE DE BPA



**4 rPET**  
Equivalente a 4 botellas de plástico

**HPOR7051**

**Thermal**  
FOOD BAG CORAL

- Portable thermal food carrier.
- RPET material: 100% recycled plastic made from 2.2 plastic bottles.
- Hot/cold insulated interior to ensure better food preservation.
- Capacity 7 L.
- Practical outer pocket to store cutlery or napkins.
- Modern and compact design.
- Seamless heat-sealed waterproof inner material.
- Sizes: 25 x 16 x 22,5 cm

||||| EAN 8436584383185

6 UNITS



**rPET**  
100% Plástico reciclado

Interior Termosellado  
Aislante frío / calor

2,2 rPET Equivale a 2,2 botellas de plástico



**HPOR7052**

**Thermal backpack**  
FOOD BAG DESERT

- RPET material: 100% recycled plastic made from 5 plastic bottles.
- Hot/cold insulated interior to ensure better food preservation.
- Great capacity: 25 L.
- 2 independent compartments.
- BPA free
- Comfortable and practical design thanks to the adjustable straps and carrying handle.
- Seamless heat-sealed waterproof inner material..
- 2 practical side mesh pockets.
- Sizes: 33 x 19 x 44 cm

||||| EAN 8436584383192

6 UNITS



**rPET**  
100% Plástico reciclado

Interior Termosellado  
Aislante frío / calor

5 rPET Equivale a 5 botellas de plástico



**HPOR7055**

**Thermal**  
FOOD BAG FOREST + 4 INNER CONTAINERS

- RPET material: 100% recycled plastic made from plastic bottles.
- Extra large opening with zippers in 2 directions.
- 4 BPA-free inner containers included: 2 of 250 ml and 2 of 800 ml.
- Hot/cold insulated interior to ensure better food preservation.
- Capacity: 5 L.
- Comfortable and practical design thanks to the adjustable strap and carrying handle.
- Practical inside pocket.
- Seamless heat-sealed waterproof inner material.
- BPA free.
- Sizes: 22 x 17 x 14 cm

||||| EAN 8436584383284

6 UNITS



**rPET**  
100% Plástico reciclado

Interior Termosellado  
Aislante frío / calor

Incluye RECIPIENTES herméticos 250ml + 800ml

3 rPET Equivale a 3 botellas de plástico



**HPOR7054**

**Children's thermal food bag**  
ARCTIC

- RPET material: 100% recycled plastic made with the equivalent of 2,3 plastic bottles.
- Hot/cold insulated interior to ensure better food preservation.
- Insulates up to 4 hours.
- Capacity 6 L.
- Adjustable padded shoulder straps.
- Hanging handle.
- Extra large opening with zippers in 2 directions.
- Practical outside pocket.
- Seamless heat-sealed waterproof inner material.
- Sizes: 23 x 11,5 x 31 cm

||||| EAN 8436584383215

6 UNITS



**rPET**  
100% Plástico reciclado

Interior Termosellado  
Aislante frío / calor

2,3 rPET Equivale a 2,3 botellas de plástico





27 x 21 x 38 cm



Adjustable elastic band



3 exterior pockets

985

## Cooler backpack TAKE AWAY

20 l

- Flexible cooler backpack.
- Capacity 20 L.
- Modern and cool design, with adjustable straps and handle.
- 3 outer compartments.
- Adjustable elastic rope.

- **PEVA lining interior:**
  - Impermeable and waterproof.
  - Toxic free, easy to clean, BPA free.
  - Hygienic and healthy, complied with FDA standard.
- Measures: 27 x 21 x 38 cm.

||||| EAN 8436017659870

6 UNITS



TOXIC-FREE  
INSULATING PLASTIC  
PEVA INTERIOR



23 x 15 x 22 cm



1.100 ml



1.500 ml

Extendable  
up to 8 cm

954

## Thermal lunch bag TAKE AWAY

EXTENDABLE UP TO 8 cm

- Flexible lunch bag.
- Extensible upper compartment up to 8 cm.
- Modern and cool design with shoulder strap.
- PEVA lining interior: Impermeable and waterproof.
- Toxic free, easy to clean, BPA free.
- Hygienic and healthy, complied with FDA standard.

- 3 outer pockets.
- 2 hermetic containers, easy opening. 1.500 + 1.100 ml
- Suitable for solids and liquids.
- Microwave (+120 °C) and freezer (-18 °C) safe.
- Dishwasher safe.

||||| EAN 8436017658774

6 UNITS



TOXIC-FREE  
INSULATING PLASTIC  
PEVA INTERIOR



32 x 26 x 34 cm



Adjustable elastic band

980

## Cooler bag TAKE AWAY

19,5 l

- Flexible cooler bag.
- Capacity 19,5 L.
- **PEVA lining interior:**
  - Impermeable and waterproof.
  - Toxic free, easy to clean, BPA free.
  - Hygienic and healthy, complied with FDA standard.

- 3 outer compartments.
- Interior compartment.
- Modern and cool design, with handle and shoulder strap.
- Adjustable elastic rope.
- Measures: 32 x 26 x 34 cm.

||||| EAN 8436017659375

6 UNITS



TOXIC-FREE  
INSULATING PLASTIC  
PEVA INTERIOR



31 x 24 x 22 cm



Top flap for easy access

970

## Cooler bag TAKE AWAY

15 l

- Capacity 15 L.
- Modern and cool design, with handle and shoulder strap.
- PEVA lining interior.
- Impermeable and waterproof.

- Toxic free, easy to clean, BPA free.
- Top flap for easy access.
- 3 outer compartments.
- Measures: 31 x 24 x 22 cm.

||||| EAN 8436017658750

6 UNITS



TOXIC-FREE  
INSULATING PLASTIC  
PEVA INTERIOR



## Tempered glass container

- Borosilicate glass body.
- Lid with vacuum function.
- Welded silicone gasket.
- Allows to preserve food healthy and hygienic.
- Free of BPA.
- Suitable for freeze and microwave, lid included. +400 °C / -40 °C
- Suitable for oven and dishwasher, without the lid.
- Hermetic, without mixing odours or flavours.
- Suitable for solid and liquid foods.

LIBRE DE  
**BPA**

TAPA CON FUNCIÓN  
**DE VACÍO**

+400 °C  
-40 °C

APTO PARA LÍQUIDOS  
**ESTANCO**



**HREC42\_**



**500 ml**

**HREC4200**

||||| EAN 8436584381532

📦 6 UNITS

Medidas: 135 x 95 mm  
Altura: 65 mm



**800 ml**

**HREC4201**

||||| EAN 8436584381549

📦 6 UNITS

Medidas: 165 x 115 mm  
Altura: 75 mm



**1.500 ml**

**HREC4202**

||||| EAN 8436584381556

📦 6 UNITS

Medidas: 190 x 135 mm  
Altura: 85 mm



**3.000 ml**

**HREC4203**

||||| EAN 8436584381563

📦 4 UNITS

Medidas: 230 x 170 mm  
Altura: 110 mm



Set of 3 pieces

**500 / 800 / 1.500 ml**

**SET HREC4204**

||||| EAN 8436584381570

📦 4 UNITS



Set of 3 pieces

**800 / 3.000 ml**

**SET HREC4205**

||||| EAN 8436584381587

📦 4 UNITS

Tata

# Vinum Series

HVIN2323



# Wine accessories set

- 16 pieces.
- Includes magnetic storage box.
- Size: 35,8 x 26,8 x 5,5 cm

HVIN2323

||||| EAN 8436584384588

📦 4 UNITS



decorative gift box sash



**HVIN2323**



**1 1 X AERATOR**

It will allow you to oxygenate the wine while you pour it into the glass



**2 1 X BOTTLE COOLER**

Keep your bottles ready with its cooling gel and cotton + nylon exterior



**3 1 X VACUUM PUMP**

Keep your bottles vacuumed for longer, preventing the oxidation of the wine



**4 2 X SILICONE STOPPERS.**

For use with the vacuum pump, they are reusable, made of TPE



**5 4 X CUPS AND GLASSES MARKER**

To mark your guests' glasses. Stackable and reusable.



**6 1 X WAITER LEVER CORKSCREW**

To remove any cork easily. Made of stainless steel and ultra-resistant.



**7 6 X ANTI-DRIP POURER.**

It will allow you not to spill a single drop of wine. It is an aluminum foil that can be reused and is easy to clean.

HVIN2201

## Electric corkscrew

USB RECHARGEABLE

- Aço inoxidável e ABS de alta resistência.
- Rotação inversa com luzes indicadoras.
- Indicador luminoso de carga.
- Adequado para qualquer tipo de tampa.
- Cabo USB tipo C incluído.
- Cortador de cápsulas incluído.
- Bateria lítio.
- Autonomia para abrir até 70 garrafas.



||||| EAN 8436584383314

📦 6 UNITS



Includes bottle opener



**USB CHARGE  
CABLE INCLUDED**







**HVIN2302**

**Cellar corkscrew**

- Double thread, continuous spiral.
- Great consistency due to its central axis and milled flavor.
- Easy to use.
- Made of zinc and polypropylene.
- Measures: 6,8 x 14,6 x 3,6 cm



**12 UNITS  
DISPLAY BOX  
46 X 11,5 X 20 cm**

||||| EAN 8436584384571

12 UNITS



**HVIN2300**

**Double lever butterfly corkscrew**

- Easy removal of the cork.
- Zinc-plated steel alloy.
- Reinforced spike.
- Built-in bottle opener.
- Measures: 6 x 16 x 3,5 cm

ALEACIÓN  
**ACERO  
ZINCADO**

**ABREBOTELLAS**



**12 UNITS  
DISPLAY BOX  
50,5 x 11,5 x 20 cm**

||||| EAN 8436584384564

12 UNITS

**HVIN2202 / HVIN2212**

**Waiter lever corkscrew**

- Lever corkscrew with double articulated impulse.
- capsule cutter knife
- Bottle opener.
- Stainless steel and ABS.



**HVIN2202**



**HVIN2212**



**HVIN2202**

||||| EAN 8436584383321

2 x 12 UDS

**HVIN2212**

||||| EAN 8436584383970

2 x 12 UDS



**12 UNITS  
DISPLAY BOX  
24 x 11,5 x 20,5 cm**



HVIN2314

## Wine oxygenator aerator

- Aerate the wine at the same time as serving.
- Anti-spill spout.
- It oxygenates the wine to bring out the best flavor and smell of the wines.
- Easy cleaning.
- Practical design.
- Sizes: 16 x 4,16 cm

EAN 8436584384410

12 UNITS

ANTIDERRAME

FÁCIL LIMPIEZA

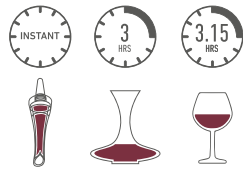
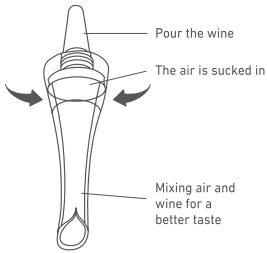

12 UNITS  
DISPLAY BOX  
30 x 11,5 x 15 cm

## Vacuum pump and 2 stoppers

- Stainless steel.
- 2 silicone stoppers.
- Perfect wine preservation. Prevent oxidation.
- Includes 1 vacuum bag of 21 x 22 cm as gift.
- Silicone adapter for vacuum valve.

HVIN2205

EAN 8436584383352

6 UNITS

INOX

2 TAPONES INCLUIDOS

PERFECTA PRESERVACIÓN DEL VINO



HVIN2205



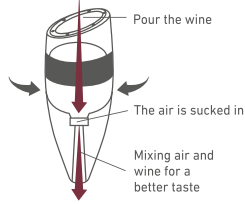

**HVIN2204**

**Gourmet wine oxygenator aerator**

- Aerate the wine at the same time as serving.
- Quick.
- Easy cleaning.
- Support base and anti-drip.
- Smart design.
- Travel pouch included.
- Sizes: 15,4 x 5,76 cm.



||||| EAN 8436584383345

📦 6 UNITS

**HVIN2206**

**Cava gourmet bottle stopper**

- Great resistance stainless steel.
- Ergonomic.
- Perfect preservation of cava.
- Quick and easy cleaning.
- Suitable for all types of cava bottles.



PERFECTA PRESERVACIÓN DEL CAVA

HERMÉTICO

||||| EAN 8436584383369

📦 12 UNITS



6 UNITS  
DISPLAY BOX  
45.5 x 11.5 x 15 cm

**HVIN2215**

**Set of 4 silicone stoppers**

- Set of 4 vacuum plugs
- Reusable platinum TPE plugs.
- Totally hermetic closure to maintain the quality of the wine once the vacuum has been made and the oxygen has been extracted.
- The wine maintains its characteristics for longer.



HERMÉTICO

100%  
SILICONA PLATINO

||||| EAN 8436584383987

📦 12 UNITS



**HVIN2207**

**Cups and glasses marker**

- Stackable.
- Practical storage design.
- Easy cleaning
- Reusable.
- It is not a toy, keep out of reach of children.



12 UNITS  
DISPLAY BOX  
30 x 11,5 x 15 cm

||||| EAN 8436584383376

12 UNITS



12 UNIDADES

**HVIN2208**

**Bottle cooler**

- Active cooling gel.
- Outer part made of cotton and nylon.
- Inner cotton that helps keeping the cold longer.
- Non-slip elastic strap system at the base, prevents the bottle from falling or sliding.



SISTEMA DE CINTA ELÁSTICA  
**ANTI CAÍDA**



**GEL REFRIGERADOR**

||||| EAN 8436584383383

6 UNITS

**HVIN2200**

**Anti-drip pourer**

- Aluminum sheet and anti-drip flexible PET Ø76 mm..
- 6 units
- Avoid contact with possible particles of the cork and the capsule, pouring the wine from the inside of the bottle into the glass.
- Easy and reusable.



CAIXA EXPOSITOR  
DE 24 UNIDADES  
14 x 11,5 x 15,5 cm

6 UNIDADES

LÁMINA  
ALUMINIO Y PET



||||| EAN 8436584383963

24 UNITS

**HBOX0122**

# Vinum Series

## Accessory display

FOR WINE

**HBOX0122**

||||| EAN 8436584384144

📦 1 UNIT



**HVIN2204**  
3 x AERATOR



**HVIN2207**  
12 x CUPS AND GLASSES  
MARKER



**HVN2208**  
8 x BOTTLE COOLER



**HVIN2202**  
20 x WAITER LEVER CORKSCREW



**HVIN2205**  
5 x VACUUM PUMP



**HVIN2212**  
10 x WAITER LEVER CORKSCREW



**HVIN2215**  
10 x SET OF 4 SILICONE STOPPERS



**HVIN2200**  
7 x ANTI-DRIP POURER



**HVIN2201**  
3 x USB RECHARGEABLE  
ELECTRIC CORKSCREW



**HVIN2206**  
4 x CAVA GOURMET BOTTLE  
STOPPER





# There is no place like home.

Grills and electric barbecues  
Made in Spain.



Find the full collection at:

[www.jata.es](http://www.jata.es)



**Jata**  
SINCE 1943



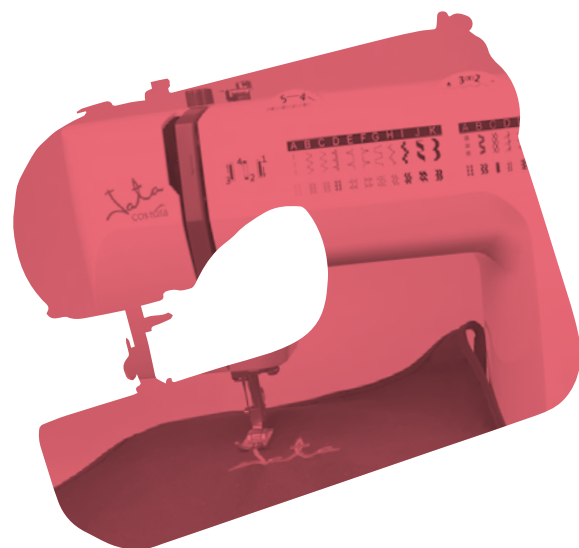
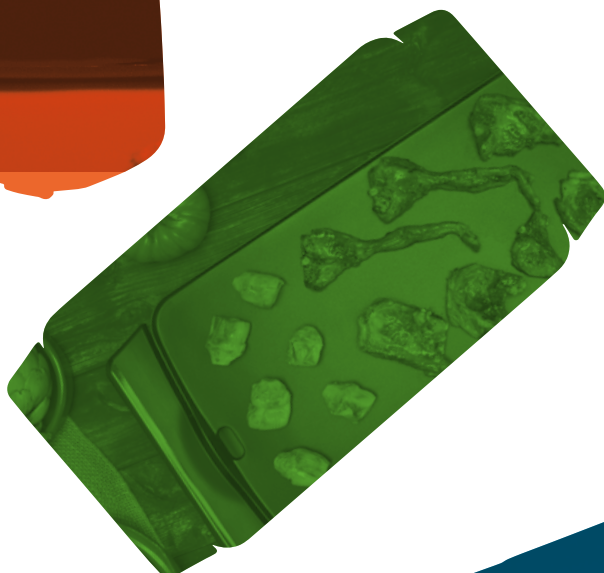

Ref. JCAT2024E



8 421078 039549

ELECTRODOMÉSTICOS JATA, S.A.

DISTRIBUCIÓN DE EQUIPOS PARA LA CASA, S.A.

## SPAIN

Polígono La Serna  
Calle D – s/nº  
31500 Tudela – Navarra  
Tel +34 94 621 55 40  
[www.jata.es](http://www.jata.es)

## PORTUGAL

Avenida Engenheiro Duarte Pacheco,  
Torre 2-3º, Sala 3 1070-102, Lisboa  
Tel: (351) 213 876 355  
Fax: (351) 213 867 398  
[geral@jata.pt](mailto:geral@jata.pt)  
[www.jata.es](http://www.jata.es)



SECRETARÍA DE ESTADO DE COMERCIO

